



















Hardware

NO.	Quantity	Accessory
A	4	 Metal Support A
B	4	 Metal Support B
C	12	 Metal Support C
D	12	 Gaske 33 mm
E	44	 Screw 8X25 mm
F	4	 Plastic leg
G	4	 Nut
H	4	 Center Leg
I	1	 Allen Wrench 5mm

King Bed

Tools Required

Power tools NOT recommended

NO.	Quantity	Accessory
A	4	 Metal Support A
B	4	 Metal Support B
C	10	 Metal Support C
D	10	 Gaske 33 mm
E	42	 Screw 8X25 mm
F	4	 Plastic leg
G	4	 Nut
H	2	 Center Leg
I	1	 Allen Wrench 5mm

Queen Bed

- 1 Install plastic foot G to headboard, siderails

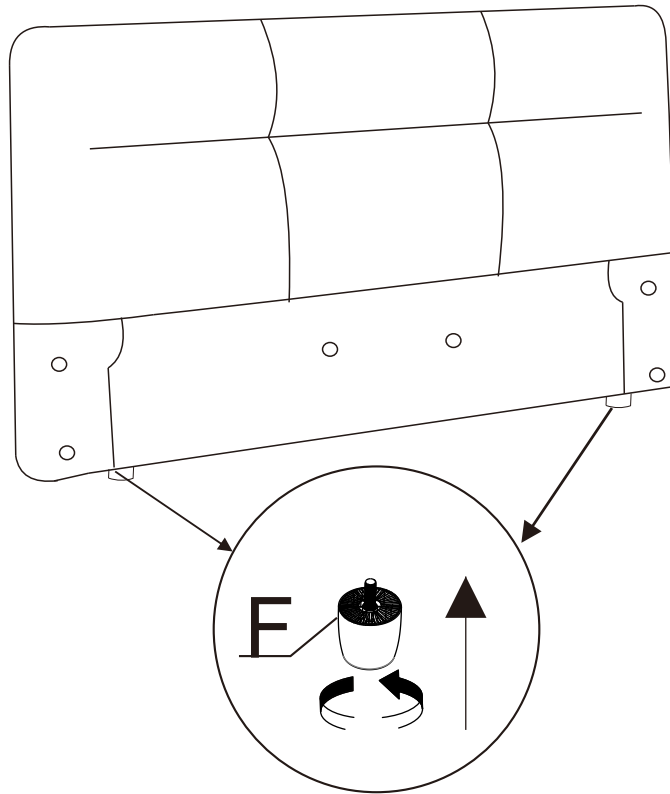

- 2 Instal Metal support A with screw D to fix headboard, siderails and footboard.

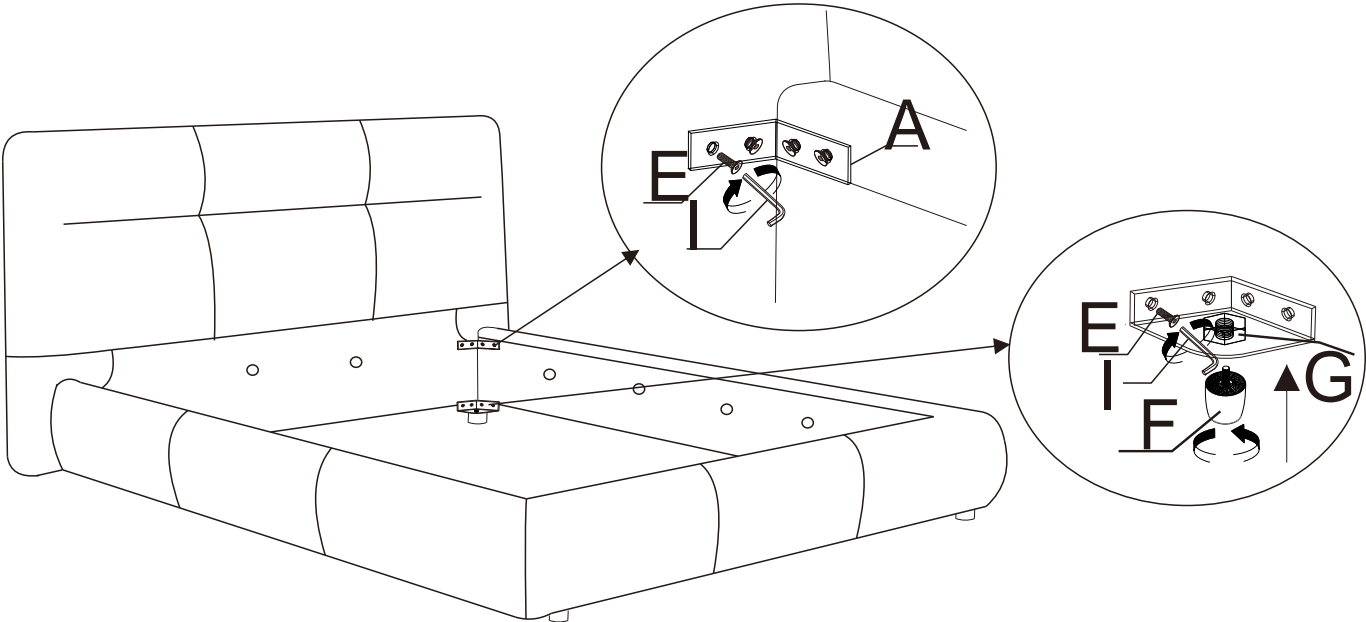

- 4 Fix metal support C with screw E and stick Gasket E.

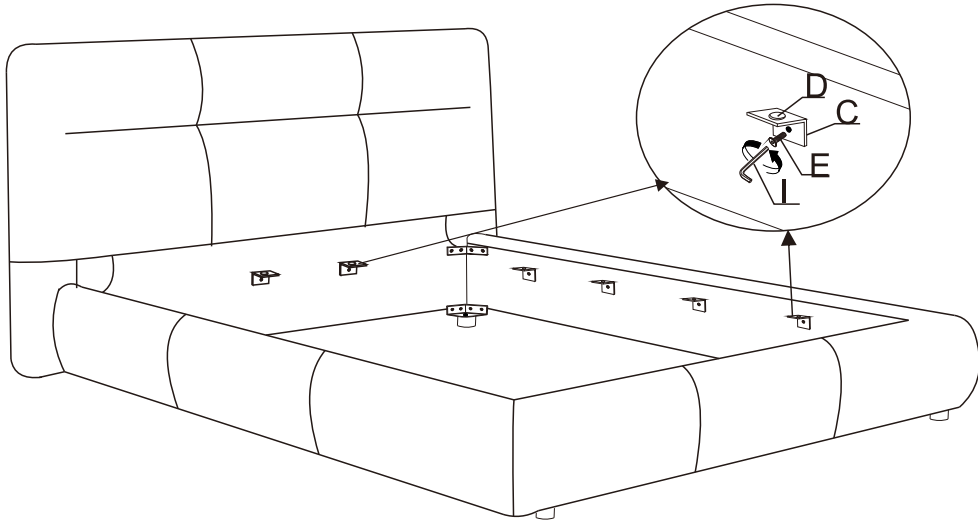

- 5 Install H legon slat and put the slat on the bed.

