

ASSEMBLY INSTRUCTIONS

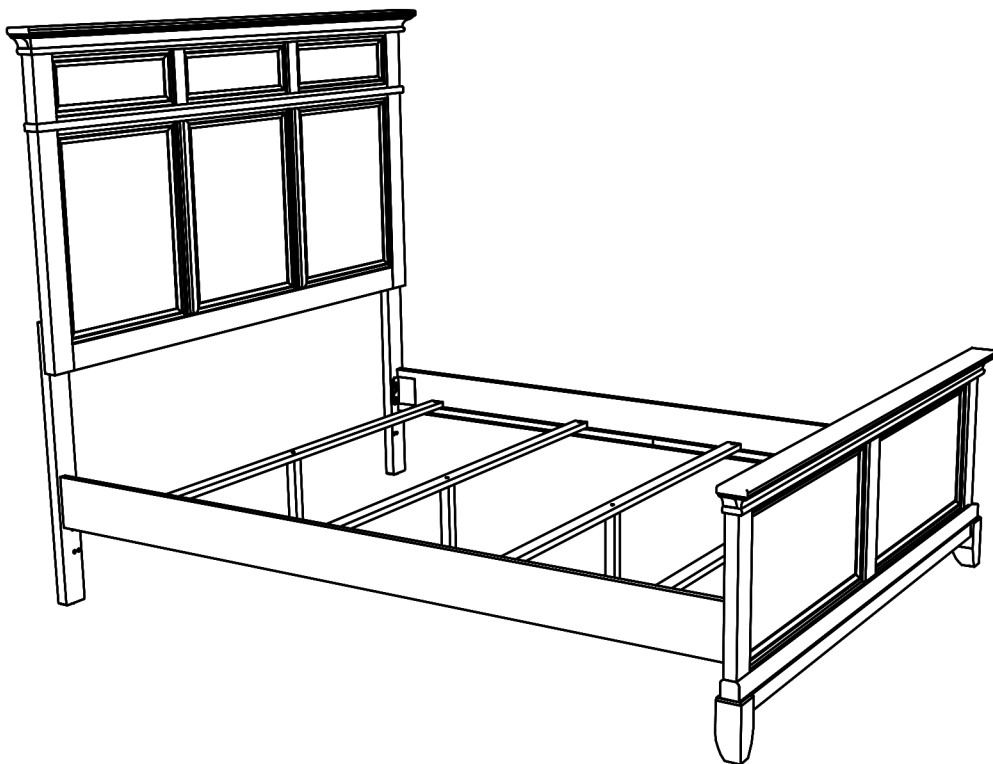

TOOLS REQUIRED

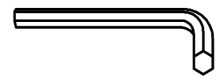

Allen Wrench

(Included)



**Phillips
Screwdriver**

(Not Included)



**2 - People
Recommended**

ASSEMBLY RATING



EASY —————> DIFFICULT

The Assembly Rating is a 5-point system showing the level of effort needed to assemble a specific product.



CHECK BEFORE STARTING

Are you missing anything?

Double-check all parts, hardware and accessories listed are all accounted for.

Should we send any replacements?

Are there any irregularities or flaws in the parts? We can send replacements!

Check out our Quick Tips!

We recommend reviewing the pre-assembly handouts. Even experts need a refresher now and then!

Prep Time!

Please review the assembly instructions and all diagrams prior to assembling.

PRE ASSEMBLY INTRODUCTION

We understand building ready-to-assemble furniture can be a challenging experience for some. To help avoid confusion, we have provided some helpful tips that may speed up the process.

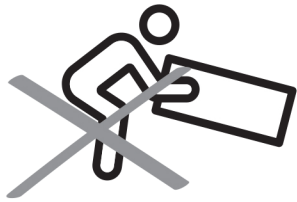

Teamwork

ALWAYS have at least two people to help with transporting and assembling the product to avoid potential injury and/or damage.

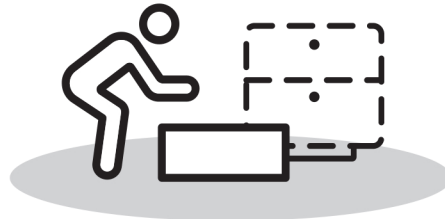
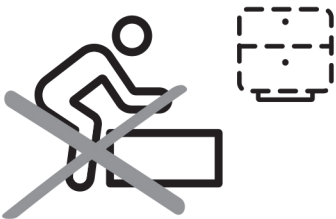

Suitable Location

Assembling near the area of the intended location is highly recommended.



Sufficient Space

Make sure you have enough space to move around during the assembly.



Avoid Scratches

Use cardboard, blankets or a carpeted area while assembling furniture to prevent to prevent scratches and damages.

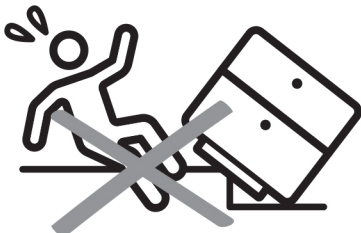

Flat Surface

Make sure the furniture rests on a flat and level surface with each leg evenly touching the floor.

ASSEMBLY AND CARE ADVICE



FAILURE TO FOLLOW THE GUIDELINES BELOW MAY RESULT IN INJURY AND/OR PROPERTY DAMAGE.



Position each part correctly and insert screws or bolts into their respective holes.

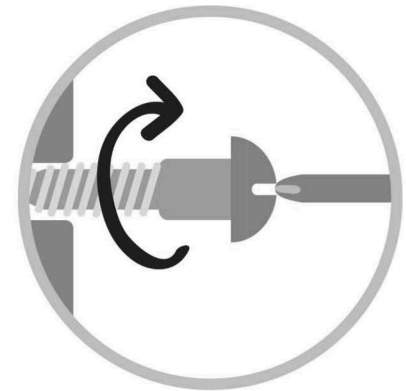

Turn clockwise to tighten and only tighten when step is completed or when instructed to do so.



Save the instructions and store any supplied tools for later maintenance.

Use the appropriate hand tools or power tools for assembly. Select steps, such as tightening screws and/or bolts, may require hand tools to avoid causing damage during assembly.



After two weeks, check and tighten any loose hardware and repeat again every six months thereafter.

IT IS THE USER'S RESPONSIBILITY TO MAINTAIN THE FURNITURE. THE HARDWARE MAY LOOSEN OVER TIME AND MAY CAUSE THE FURNITURE TO BE WOBBLY AND UNABLE TO SUPPORT ITS INTENDED WEIGHT CAPACITY. THIS MAY LEAD TO COLLAPSE AND MAY CAUSE SERIOUS INJURY.

QUEEN SIZE BED



- Please keep instructions for future reference.
- Check the quantity and irregularity of parts and hardware before you start.

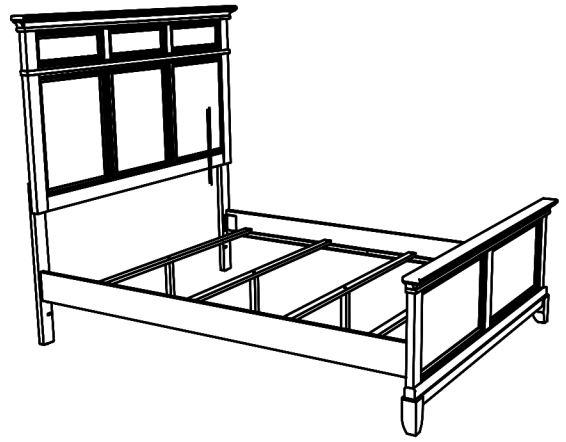

PARTS

#1 1pc



Headboard

#2 1pc

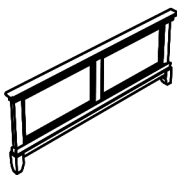

Footboard

#3 2pcs



Headboard
Leg(L&R)

#4 4pcs



Bed Slat -
1545x45x18mm

#5 4pcs

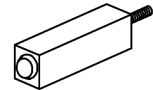

Bed Slat Support -
230x30x30mm
(INCLUDED LEVELER)

#6 2pcs



Side Rail

HARDWARE

#A 6pcs

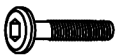

Bolt 1/4" x 1-3/16"

#B 6pcs



Lock washer

#C 6pcs



Flat washer

#D 1pc



Allen Key
M4 x 65mm

#E 1pc

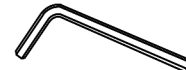











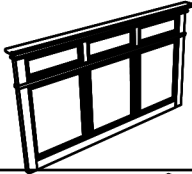

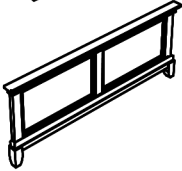
Allen Key
M5 x 65mm

#F 8pcs



CSK M4 x 32mm

CM7221Q is packed in 2 cartons

Carton	Designation		Part	Hardware
CM7221Q -HBFB	Queen Size Bed HB	#1		 #A x 6pcs
	Queen Size Bed FB	#2		 #B x 6pcs
	Headboard Leg(L&R)	#3	 Nail Leg	 #C x 6pcs
	Bed Slat	#4		 #D x 1pc
	Bed Slat Support	#5		 #E x 1pc
				 #F x 8pcs
CM7221Q-R	Side Rail	#6		

ASSEMBLY INSTRUCTIONS

1

Align and attach Headboard Leg (L&R) (#3) to Headboard (#1).
Secure using Bolt (#A) with Washers (#B, C)

Part #1 x1pc

Part #3 x2pcs

Hardware #A x6pcs

Hardware #B x6pcs

Hardware #C x6pcs

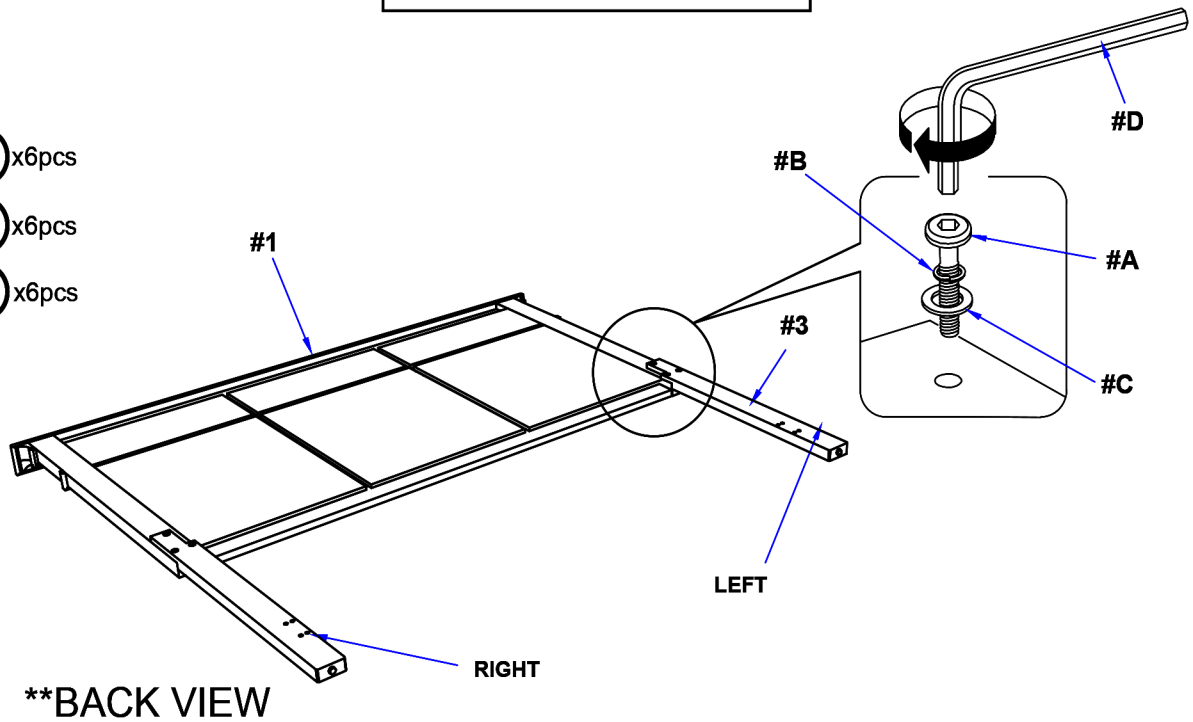

2

Part #2 x1pc

Part #6 x2pcs

Align and Attach Side Rail (#6) to Footboard (#2) and Headboard Legs (L&R) (#3).
Secure using Allen Key (#E)

