

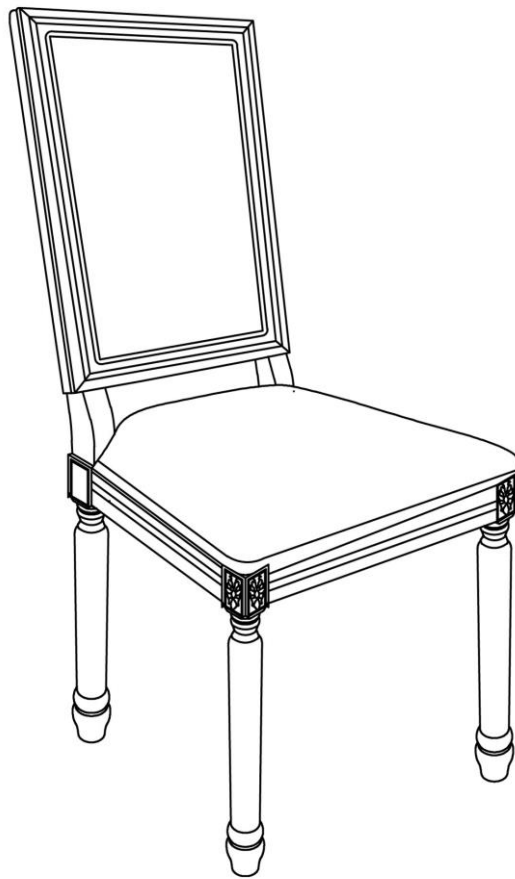

Assembly Instructions

Caution : You must read this before you proceed



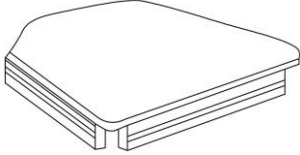
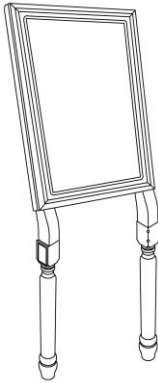

Chair



Parts List

Label	Picture	Description	QTY
A		Seat	1
B		Back with Legs	1
C		Front Leg	2

Hardware

Label	Picture	Description	QTY
①		Bolt (M8*60MM)	9
②		Spring Washer	9
③		Washer	9
④		Allen Key	1

Assembly Preparation

Before Beginning Assembly:

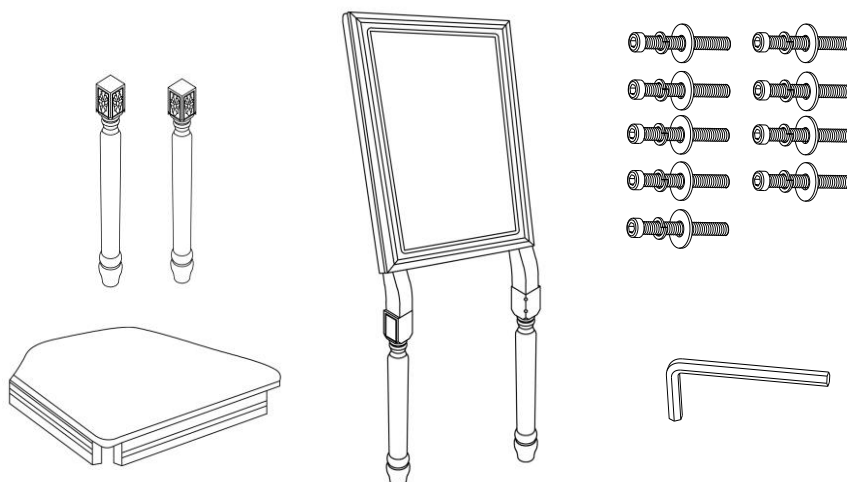

- Read instructions, cover to cover-



- Have 2 adults on hand for assembly-



- Do not assemble on flooring or carpet-



- Assemble on a clean non-marring surface (packing foam)-



- Save all packaging until finished-

Assembly Steps

Overview

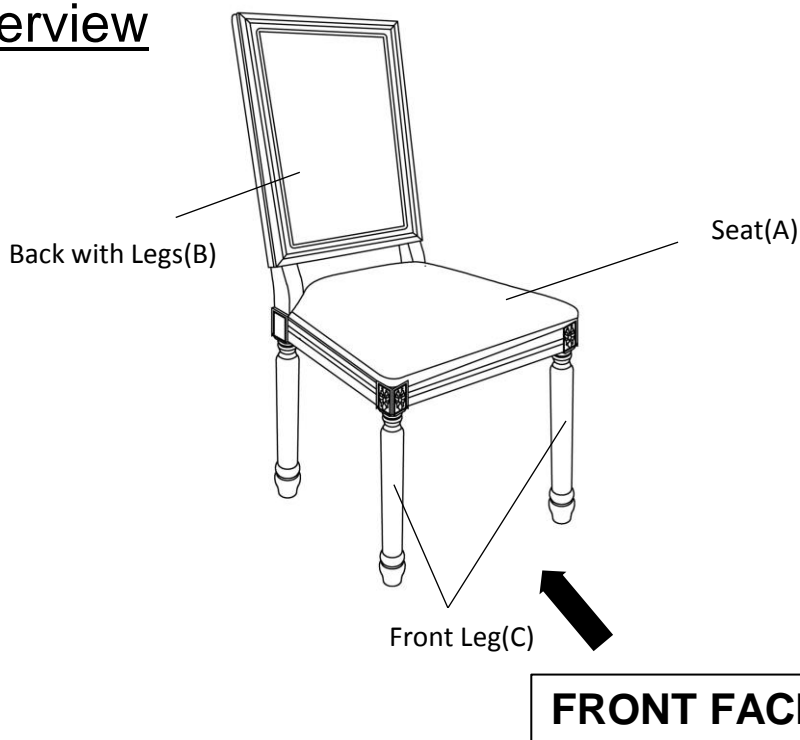

This Chair has multiple parts and may require up to 30 minutes to assemble. To give you an overview of the Chair parts, the above picture is to help you put the various parts into perspective. Please read through the instructions below to familiarise yourself with the parts and steps before assembly.

Step 1

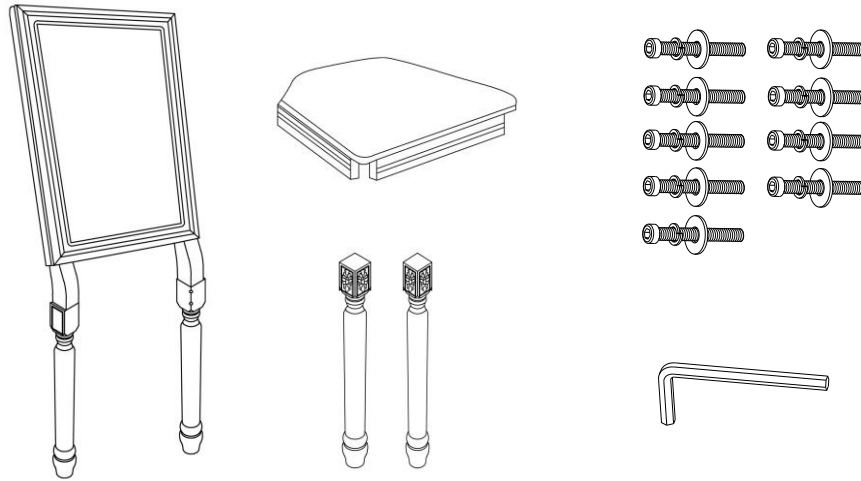

Unpack and place all parts on a clean, non-marring surface.

Step 2

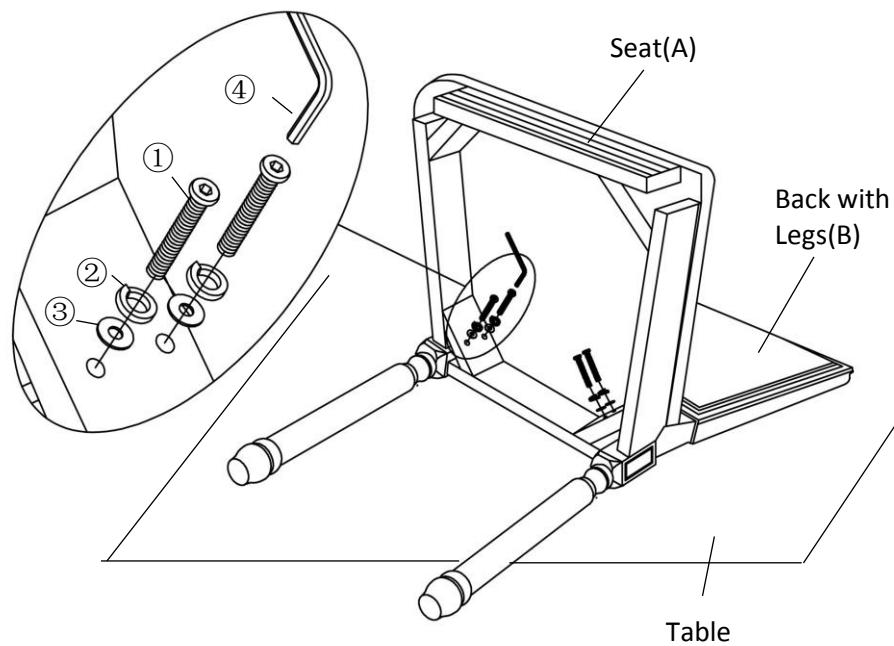

Place the Back with Legs(B) on a clean, non-marring surface. Align the mounting positions of the Seat(A) and Back with Legs(B), then attach them using Bolts(①), Spring Washers(②) and Washers(③) with Allen Key(④).

Friendly notice:

If the mounting positions cannot be aligned well which hinders the installation, then sway the Seat(A) lightly when locking the Bolts, this action could help prevent the Bolts from getting stuck and ensure smooth assembly.

Do not fully tighten the Bolts.

Step 3

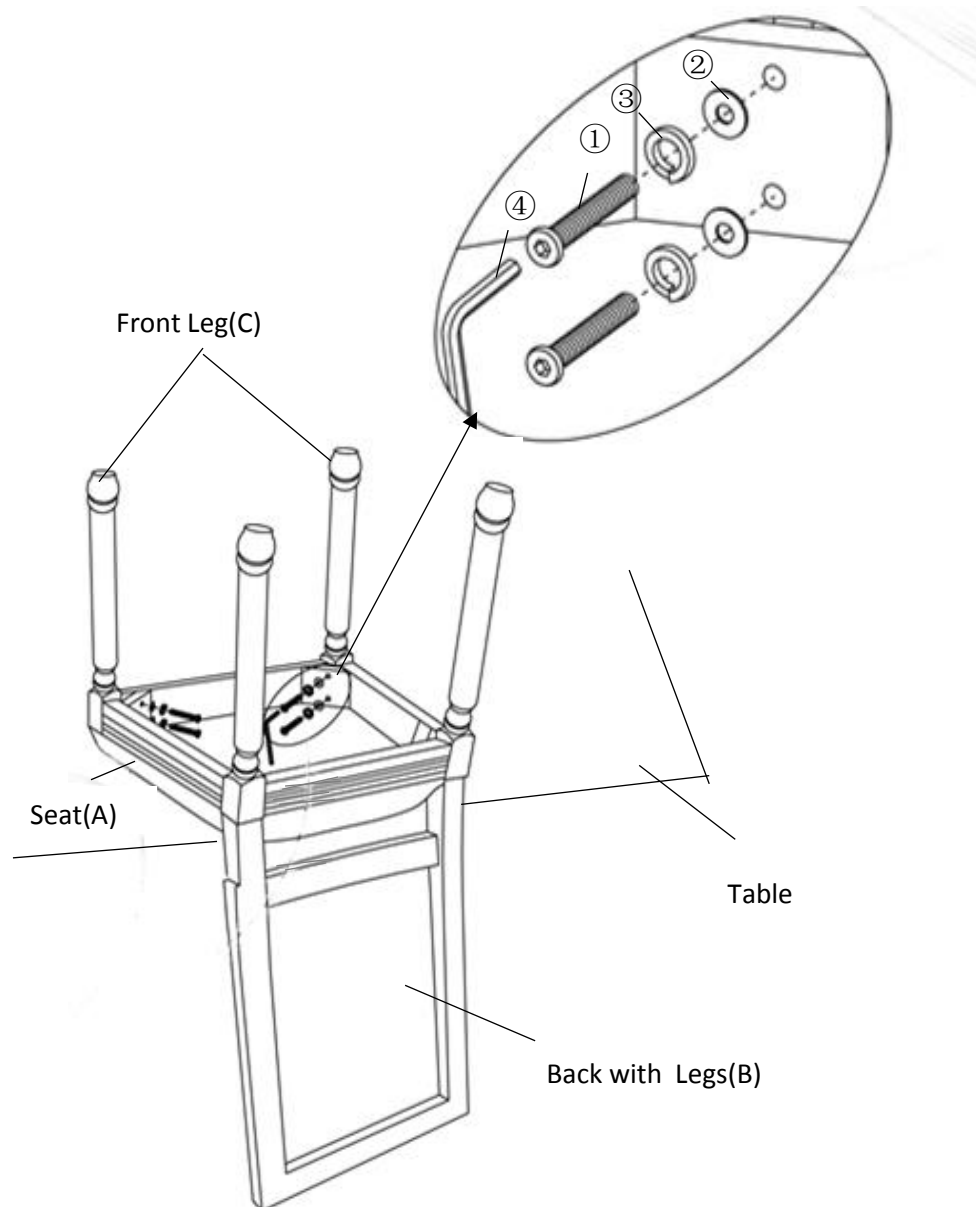

Place the Seat(A) on the side of a table, with the Backrest facing down and perpendicular to the Desk Top, as pictured. Insert Front Legs(C) into the mounting positions of Seat(A) and attach using Bolts(①), Spring Washers(②), and Washers(③) with Allen Key(④).

Do not fully tighten the Bolts.

Step 4

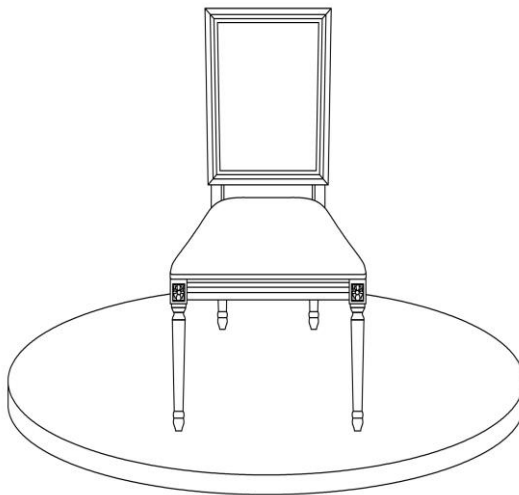

1 if wobble

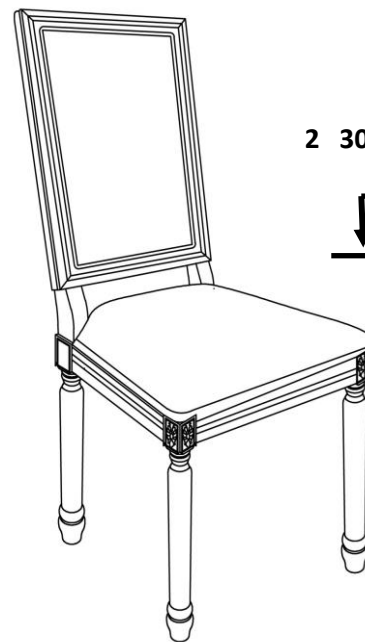

2 30-50cm



3 Test again



Place the Chair on a level Surface to check if it wobbles.
If it is wobbles, lift the Chair some 30cm to 50cm high from the ground.

Keep your feet and toes well away from the drop zone.
Drop the Chair freely and vertically, with all four legs hitting the ground at the same time.

This Drop Test will help to ensure that all the Parts, Bolts, and gaps reach full alignment status.

Test again for evenness on a Level Surface.

If no wobbles are found, proceed to tighten all the Bolts.

When tightening the Bolts, tighten sequentially.

Do not fully tighten any Bolt fully and then move on towards the next one.

This may cause the frame to warp.

If there are still wobbles, loosen the Bolts and execute this same drop test.



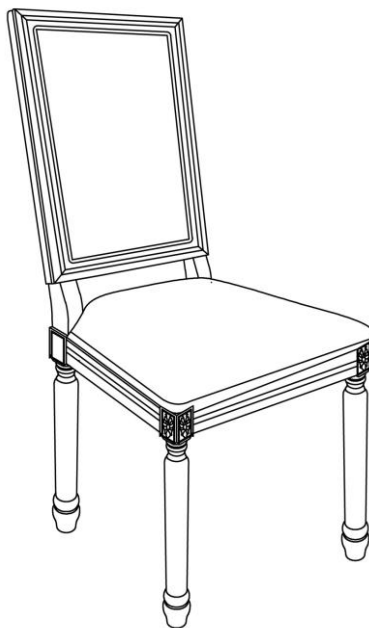

















Step 5



Your Chair is ready for use.

This Chair can only be used on a flat, level surface.

Care & Maintenance

-   ● Do not put hot items directly on furniture surface.
 -   ● Do not clean furniture with harsh cleansers or polish.
 -   ● Do not place furniture under direct sunlight.
 -   ● Do not place furniture near heating or cooling vents.
 -   ● Do not write on furniture without a padded barrier to protect the surface.
 -   ● Do not place furniture outside. For indoor use only.
 -   ● Not for commercial use. For residential use only.
 -   ● Stains may be removed with mild soap solution and damp cloth.
 -   ● Children should not climb or jump on the furniture.
-
-   ● Dust and pick-up spills using a clean, non-colored, lint-free cloth.

Questions & Answers about Proposition 65

• What is Proposition 65?

Proposition 65 requires businesses to provide warnings to Californians about significant exposures to chemicals that cause cancer, birth defects or other reproductive harm. These chemicals can be in the products that Californians purchase, in their homes or workplaces, or that are released into the environment. By requiring that this information be provided, Proposition 65 enables Californians to make informed decisions about their exposures to these chemicals.

Proposition 65 also prohibits California businesses from knowingly discharging significant amounts of listed chemicals into sources of drinking water.

Proposition 65 requires California to publish a list of chemicals known to cause cancer, birth defects or other reproductive harm. This list, which must be updated at least once a year, has grown to include approximately 900 chemicals since it was first published in 1987.

• What types of chemicals are on the Proposition 65 list?

The list contains a wide range of naturally occurring and synthetic chemicals that include additives or ingredients in pesticides, common household products, food, drugs, dyes, or solvents. Listed chemicals may also be used in manufacturing and construction, or they may be byproducts of chemical processes, such as motor vehicle exhaust.

• What does a warning mean?

If a warning is placed on a product label or posted or distributed at a workplace, a business, or in rental housing, the business issuing the warning is aware or believes that it is exposing individuals to one or more listed chemicals.

By law, a warning must be given for listed chemicals unless the exposure is low enough to pose no significant risk of cancer or is significantly below levels observed to cause birth defects or other reproductive harm.

• Where can I get more information on Proposition 65?

If you have specific questions on the administration or implementation of Proposition 65, you can contact OEHHA's Proposition 65 program at P65.Questions@oehha.ca.gov, or by phone at (916) 445-6900.