

# INSTRUCTION MANUAL

## for Installing

# INVISIDOOR HINGE KIT

ID.HINGEKIT



The Invisidoor Hinge Kit is **designed and manufactured** in the USA and offers:

- Easy installation; comes complete with detailed Installation Instructions.
- Universal design; can be used for inswing or outswing, left-hand or right-hand doors
- Durable powder-coated ¼" thick steel hinge plates
- Adjustable support foot
- Quiet, smooth pivoting action
- All fasteners included
- (Bookcase not included)



# Instruction Manual for InvisiDoor Hinge Kit Installation

## Hinge Kit Includes:



## Installation Tools Needed:

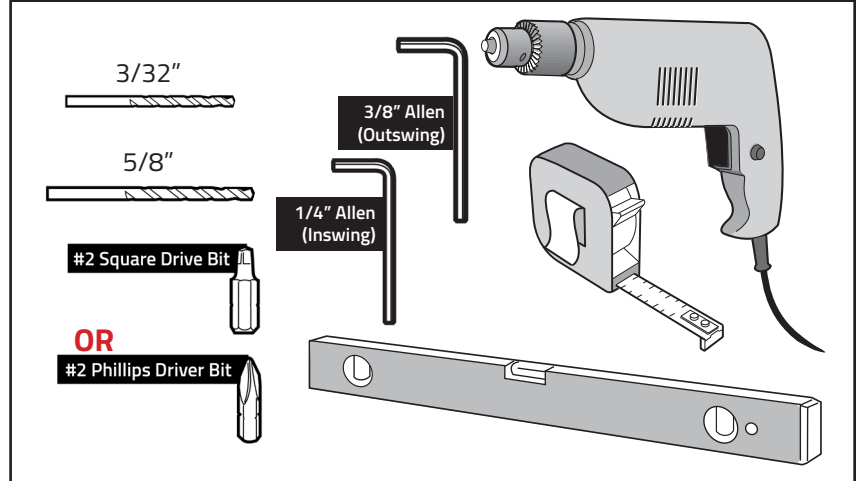

### Wall Opening Preparation

1. Check the opening into which the InvisiDoor will be installed to verify that it is plumb and level. Correct operation and appearance of the InvisiDoor requires that the opening be level and plumb or you need to make accommodations for it.
2. The InvisiDoor pivot hinge is designed to be installed with the bottom hinge plate secured to stable, solid wood. Verify that the floor of the opening has adequate support for weight of the unit and holding power for the screws.
3. It is recommended that you test mount the hardware and install the InvisiDoor prior to applying stain and finish coat. This will eliminate the chance of damaging the finished product during the process of mounting the hinges and adjusting the unit.

#### **Special note:**

- *When the bookcase door is in the opened position there will be loss of space in the opening; 10" for the outswing bookcase, 8" for the inswing.*
- *Max wall thickness for inswing door is 6" (cannot use a 2x6 wall with drywall on both sides without modification). Can add 3/4" to the inside of the casing, this will push the InvisiDoor in 3/4", then you can use the InvisiDoor in a 2x6 standard wall construction.*
- *Weight rating: Max 300lbs., including the weight of the bookcase (the CSH 36" wide InvisiDoor bookcase weighs approx. 70lbs).*

### Building the Bookcase

- Dimensions given with these instructions are based on the size of the universal InvisiDoor (for a standard 36" Wide x 80" High finished opening) to assist you in sizing your bookcase and finding the appropriate hinge locations.
- Modifications to the width or depth of the bookcase will likely require you to change the spacing allowed for clearance or the location of the hinge pivot point. In all cases, it is recommended that you create a template to mock-up the dimensions of the opening and the bookcase to verify that you have the necessary clearance for your door to operate properly.
- Below are the design recommendations based on our universal bookcase (modify design as appropriate for custom applications).

#### Materials:

- *3/4" hardwood cabinet-grade plywood; sides, top and bottom, shelves*
- *One (1) fixed shelf, three (3) adjustable shelves, 6 5/8" deep*
- *Top, bottom, and fixed shelf are dadoed, glued, and brad nailed into sides for strength to prevent racking.*
- *1/2" plywood glued and fastened to the back (sides, top, bottom and fixed shelf) for strength to prevent racking.*
- *The face frame is 3/4" thick x 2 1/4" wide with the edges rounded over with a 3/8" radius router bit, and glued and nailed to the bookcase carcass.*

#### Construction:

- *Top of the bookcase is centered on the face frame (3/4" difference between the top of the bookcase and the top of the face frame. 1/2" plywood block and the 1/4" hinge plate #2 makes the top of the hinge plate flush with the top of the face frame).*

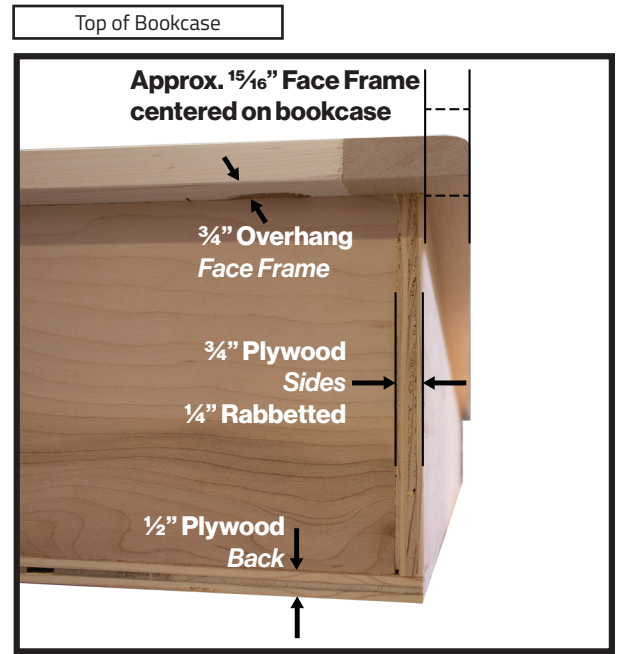

- Bottom shelf of the bookcase is  $\frac{1}{8}$ " below the top edge of the bottom face frame rail.

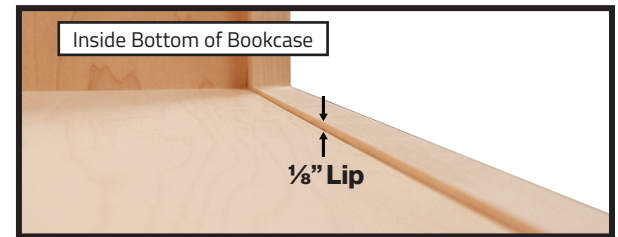

- Sides and back run down past the bottom shelf, but not as far as the face frame (forms a pocket on the bottom of bookcase. Sides and back extend  $\frac{3}{4}$ " below the bottom shelf. The face frame extends approximately  $1\frac{3}{8}$ " below the bottom shelf)
- Mounting blocks are screwed into this pocket. The thickness of the blocks may need to be adjusted based on the clearance and spacing needed for door.

The pocket on the bottom of the Invisidoor is approximately  $1\frac{3}{8}$ " deep. (Bottom of the bookcase to the bottom edge of the face frame.)

The thickness of Hinge Plate #3, plus the 3 washers, plus Hinge Plate #1 =  $1\frac{1}{16}$ "

That leaves  $1\frac{1}{16}$ " space plus whatever desired clearance gap between the bottom of the face frame and the floor surface where the bottom hinge plate is attached.

(The required gap height will depend on how level the floor is within the swing of the bookcase.)

**Example:**

Using two  $\frac{1}{2}$ " thick plywood blocks attached to the bottom of the bookcase plus the two Hinge Plates and three washers will total  $1\frac{1}{16}$ "; producing a gap of approximately  $\frac{5}{16}$ ".

Decrease or increase this gap by adjusting the thickness of the blocks.

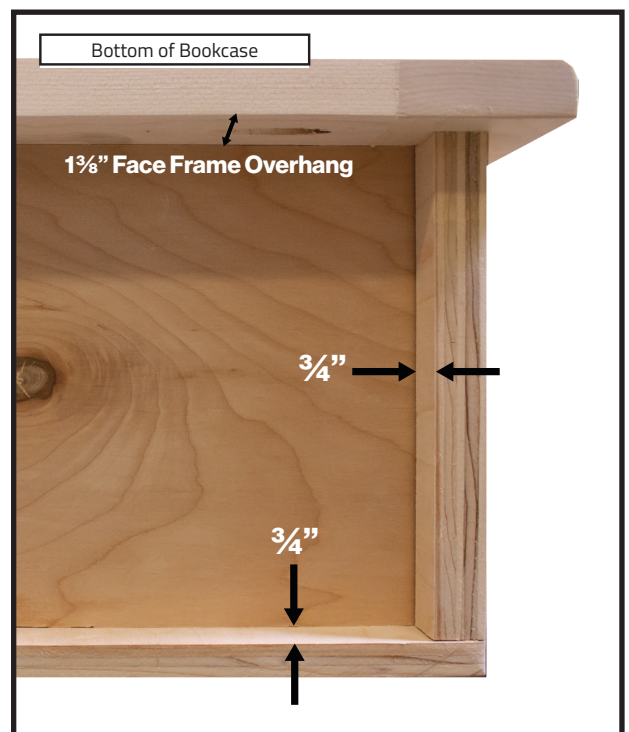

Hinge Plate #1

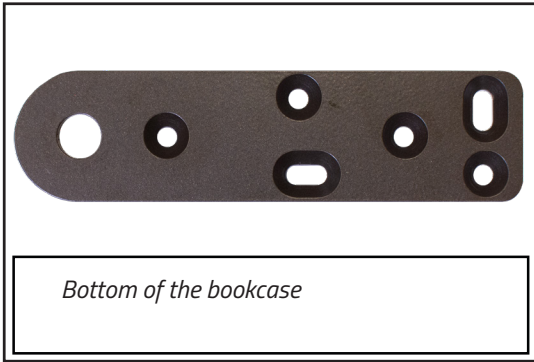

Hinge Plate #2

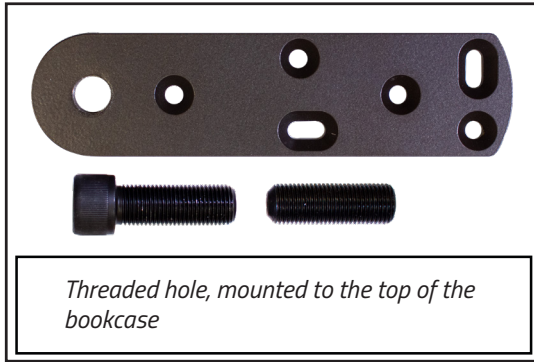

Hinge Plate #3

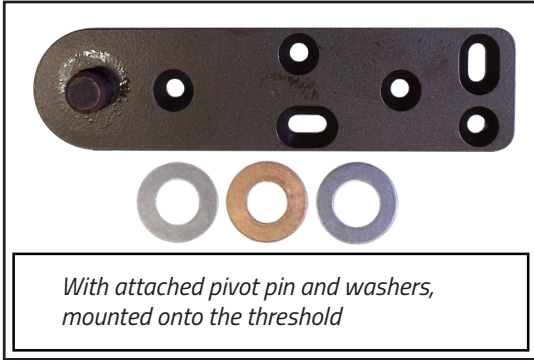

Hinge Plate #4

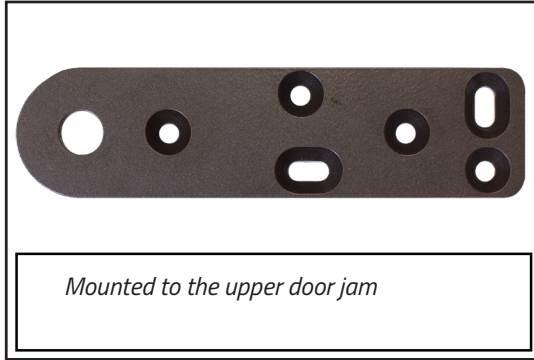

### Pivot Hinge Installation

Use the diagrams to identify locations for the pivot hinge to be installed on the left or right side of the unit as either an outswing (which pulls out toward the bookcase side) or an inswing (which rotates away from the bookcase side). In most cases, the bookcase face frame will be flush with the drywall. The casing trim will later be mounted over the drywall and bookcase face frame, spanning across the jamb.

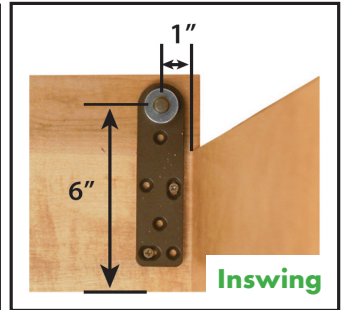
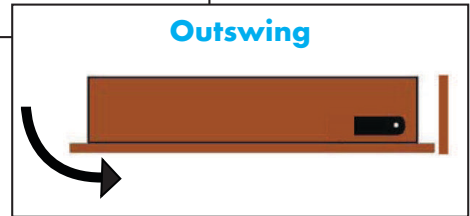
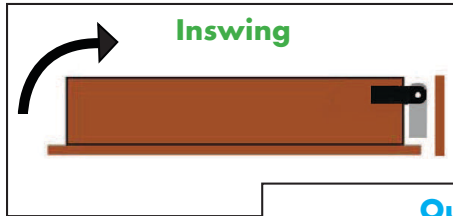

### Hinges to Door Opening Installation

- To install **hinge plate #3** to threshold/floor:
  - Place the two steel washers and the bronze bearing onto the hinge pin as shown.
  - Use the  $\frac{7}{8}$ " screws into the two slotted holes at first to allow for adjustments. When the door has been installed and functioning properly, secure the plate with the remaining screws to the threshold/floor.

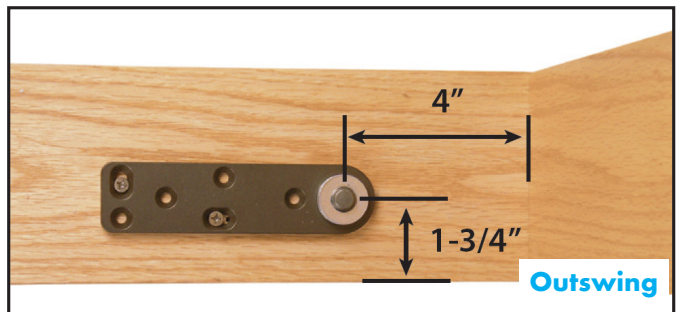

2. To install hinge plate #4 to the upper jamb.
  - *Shim the jamb as needed at location of pivot hinge for a solid mounting area between the upper jamb and the door header. The longer 2 ¼" screws will be used to solidly secure this hinge plate through the jamb and into the header once the bookcase is in its proper location.*

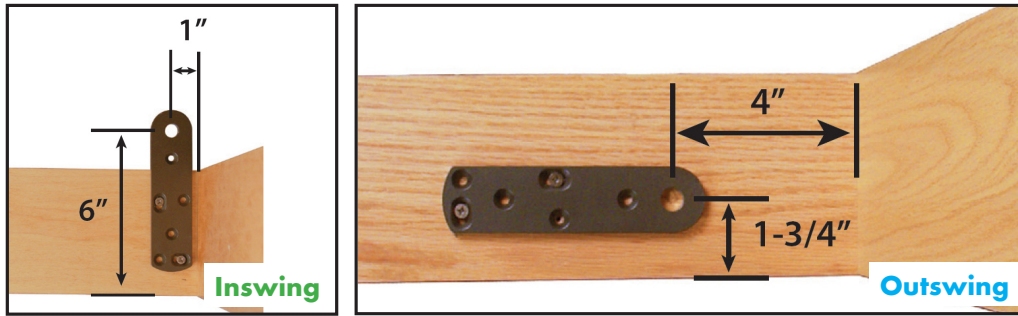

### Hinges to Bookcase Installation

1. Install mounting blocks to the hinged side of the bookcase unit (typically two ½" blocks measuring 6 5/8" x 8" on the bottom and a ½" block of same width and length on the top).

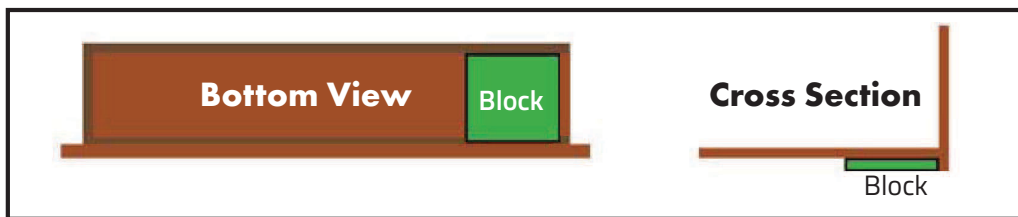

2. Use the mounting diagram to install hinge plate #1 to the **bottom of the bookcase**.

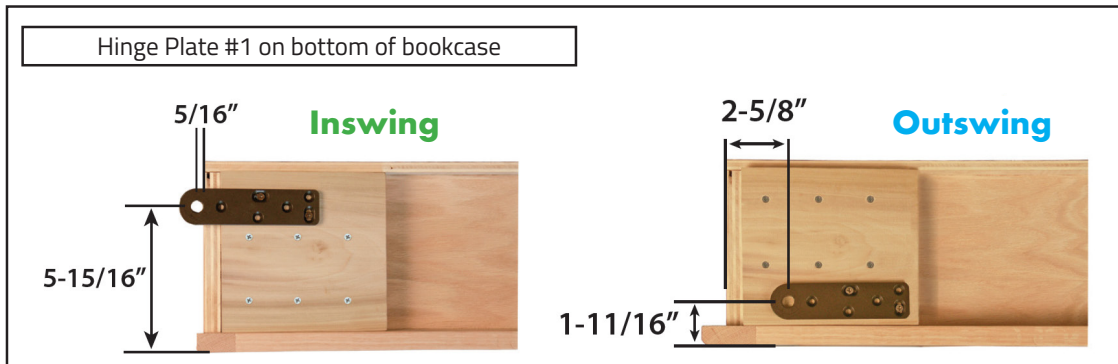

3. Mount hinge plate #2 to the **top of the bookcase**. Hinge plate #2 should be flush with the top edge of the face frame.

*Important Note: Prior to installing the upper hinge on an outswing door to the bookcase, an access hole for the set screw must be drilled through the top of the bookcase. Use the diagrams for the location of this hole. (Predrill a small hole from the top of the bookcase. Then drill a 5/8" hole from the inside of the bookcase through the top to avoid tear out inside the bookcase)*

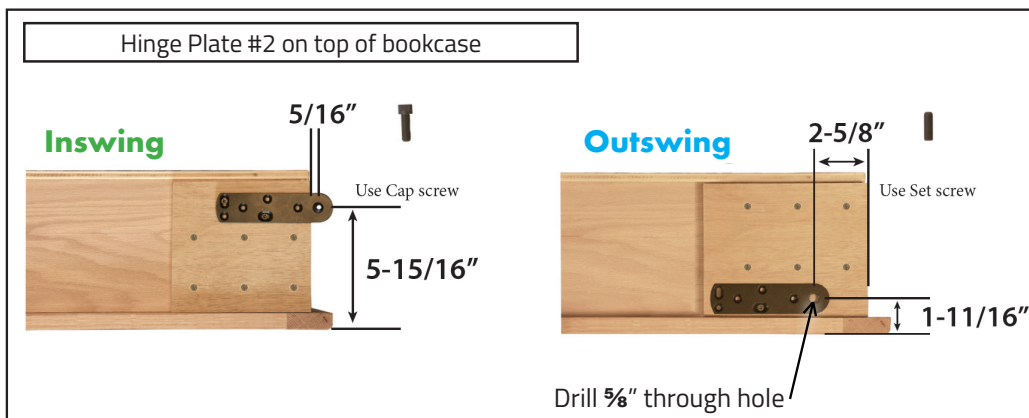

## Bookcase Installation

- Lift the bookcase into the opening.  
*Inswing bookcase: mounts from the inside of the opening*  
*Outswing bookcase: mounts from the outside of the opening*
- Set the hinge plate located on the bottom of the bookcase onto the pin of the hinge plate located on the threshold/floor. Be sure the washers are in place.
- Align the upper hinge plate located on the top of the bookcase (hinge plate #2) with the upper hinge plate located on the header (hinge plate #4). Use Loctite on the set screw threads to prevent the screws from twisting loose over time.
- **Inswing bookcase:** screw the capscrew (with head) down through the hinge plate located on the header and into the threaded hinge plate located on the top of the bookcase.
- **Outswing bookcase:** Using a  $\frac{3}{8}$ " Allen drive, screw the set screw (no head) up through the access hole that is located in the inside top of the bookcase, through the threaded hinge plate on the top of the bookcase and into hinge plate located on the header.
- Verify the fit of the casing trim against the installed Invisidoor. A slight gap between the face frame of the bookcase and casing trim is necessary to allow clearance for the bookcase to swing.
- Adjust hinges as needed by using slotted holes in hinge plates. Pre-drill holes for remaining screws for each of the hinge plates. The provided  $2\frac{1}{4}$ " screws will be used to secure hinge plate #4 through the upper jamb into the door header.

Inswing



Outswing

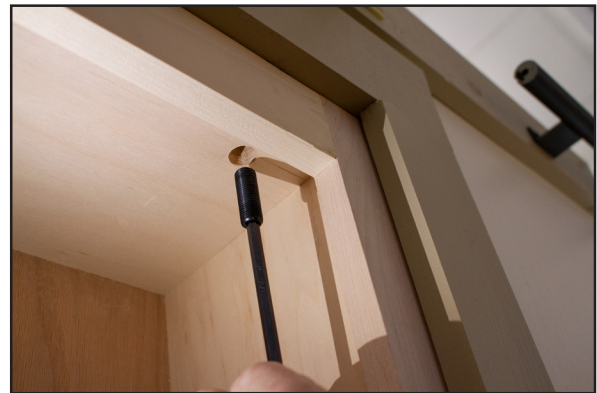

Inswing

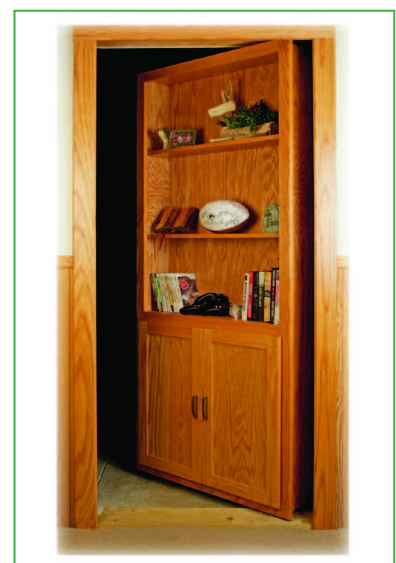

## Casing Trim Installation

Inswing bookcase:

- Trim on both sides and the top of the door are mounted to the wall and serve as a stop for the door. Avoid using trim that has a narrow inside edge as it will not hold up as a stop. A  $\frac{3}{4}$ " thick molding is recommended.
- It is also recommended that the trim overlay the face frame by  $\frac{1}{2}$ "-  $\frac{3}{4}$ ".
- A wide variety of trim styles will work for the inswing mounted Invisidoor. Corner blocks, mitered corners, or built out crowns can all be used without interfering with the function of the door.

Outswing



Outswing bookcase:

- Trim on the hinge side of the bookcase and the top will be attached to the wall, but the non-hinged side trim will be attached to the bookcase to act as a stop.
- It is recommended that the trim overlay the face frame by 3/4" and be mounted very securely to withstand the opening and closing of the door.
- The trim across the top of the door must be mounted to allow clearance for the door to swing below it.
- Allow clearance for the door-mounted trim to swing freely from the upper piece of trim as well as clear the floor.

Inswing, support bolt bracket



Inswing, tapered stop



**Support Foot Installation**

- Mount bracket to the side of bookcase opposite from the hinge side.
- Bracket must be attached near the face frame to allow enough clearance to swing past the jamb.
- Align the tapered stop to the location of the support bolt when the door is in the closed position, mark the location, fasten it with the supplied tape/and or screw.
- Adjust the support bolt up or down to desired tension.

Outswing, support bolt bracket



Outswing, tapered stop



Congrats on installing your InvisiDoor!