

# Installation & Assembly

## DIMENSIONS

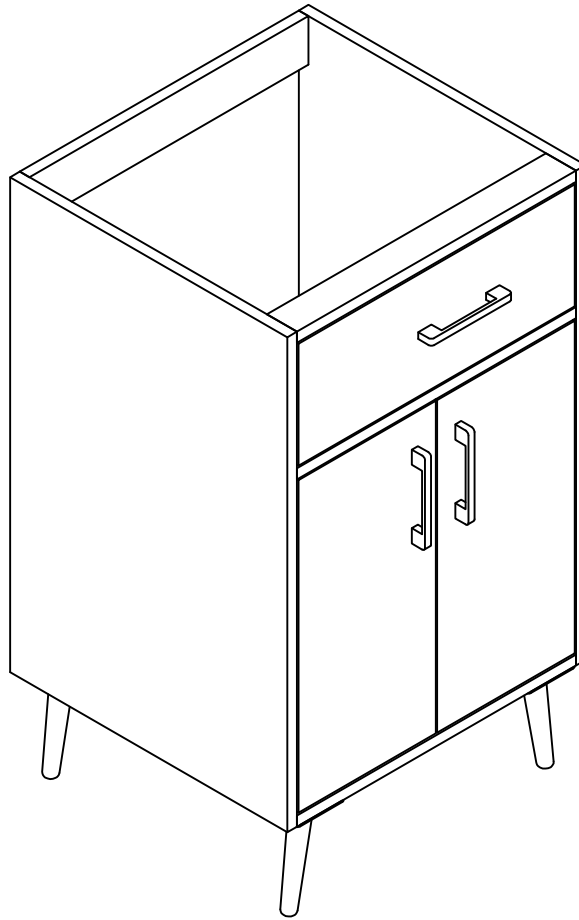

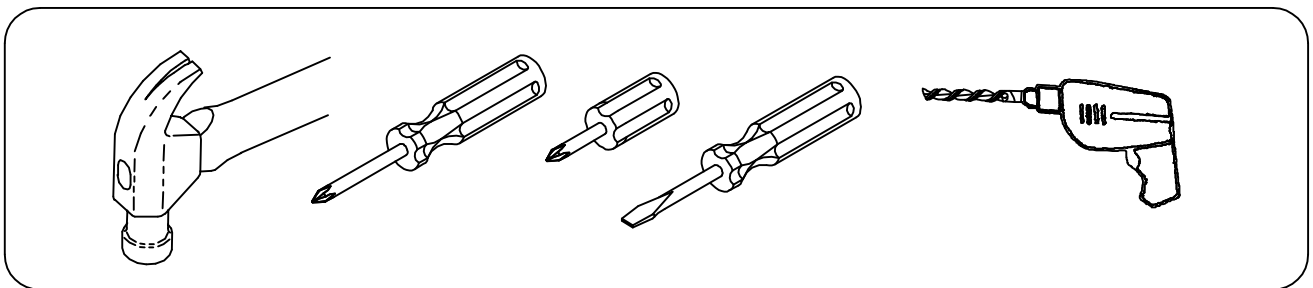





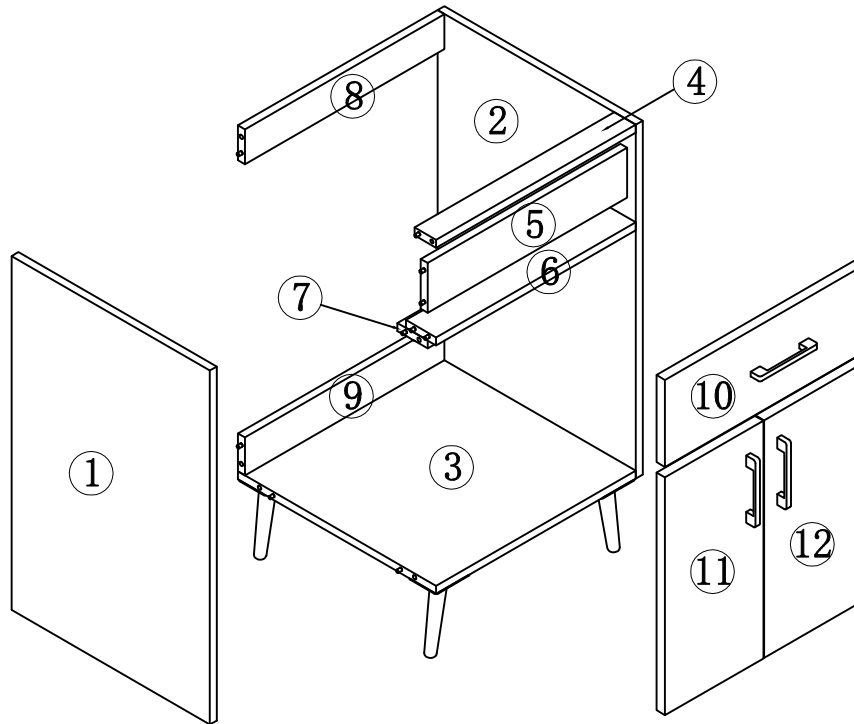





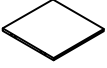









## YOU MAY NEED (NOT SUPPLY)



# ASSEMBLY DIAGRAM



PARTS LIST					
PARTS LIST					
NO	DESCRIPTION	QTY	NO	DESCRIPTION	QTY
①	Left side panel 	1	⑦	Front fixed panel 	1
②	Right side panel 	1	⑧	Back fixed panel 	1
③	Bottom panel 	1	⑨	Back fixed panel 	1
④	Front fixed panel 	1	⑩	Back fixed panel 	1
⑤	Front fixed panel 	1	⑪	Left door panel 	1
⑥	Front fixed panel 	1	⑫	Right door panel 	1

PARTS LIST					
HARDWARE LIST					
NO	DESCRIPTION	QTY	NO	DESCRIPTION	QTY
A	Three-in-one eccentric wheel 	12	G	4*16mm screw 	40
B	Three-in-one connecting rod 	12	H	4*30mm screw 	2
C	Three-in-one sticker 	12	I	4*23mm screw 	4
D	8*40mm wood dowel pins 	20	J	4*18mm screw 	2
E	Door hinges 	4	K	Metal feet 	4
F	Door handle 	3			
CAUTION: Please confirm the parts list before installation					

# STEP 1

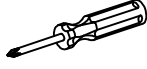
HARDWARE LIST	
Three-in-one connecting rod B  12PCS	

1. Put the three-in-one connecting rod in the 10mm hole of the following panels and tighten them with a cross screwdriver or an electric tool.

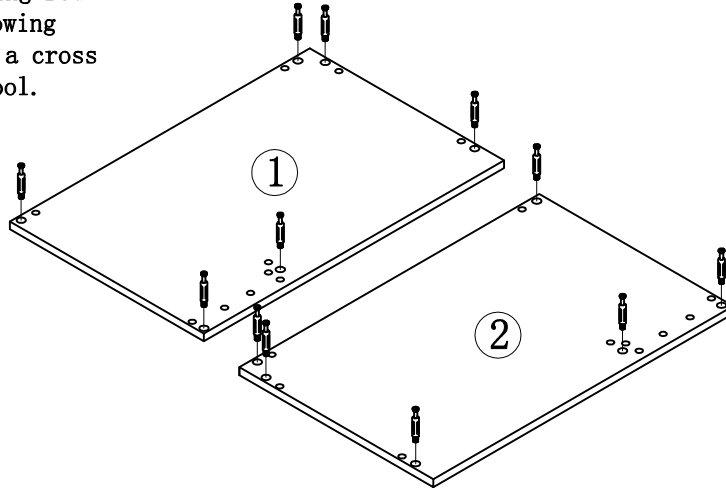
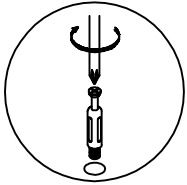

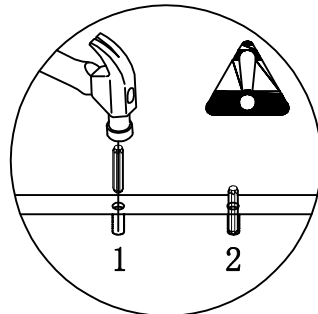

# STEP 2

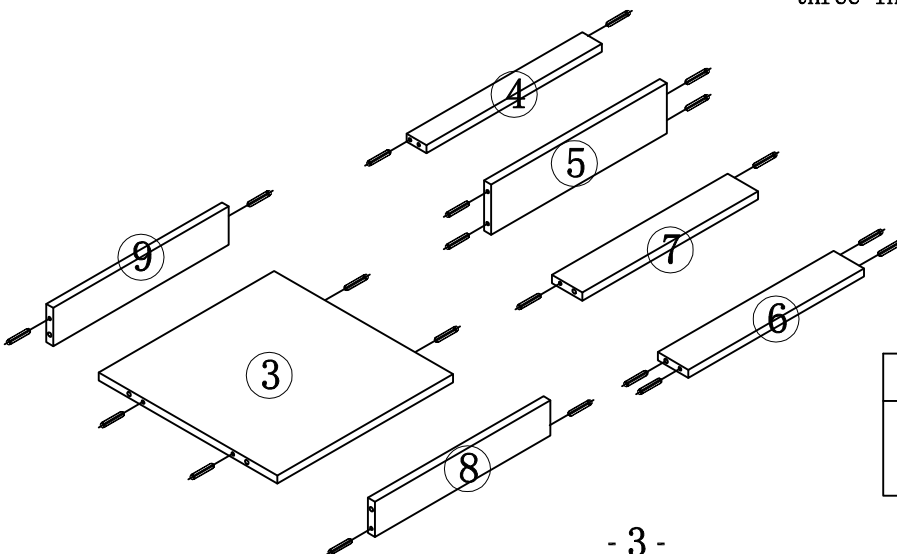

1. Strike the 08\*40mm wood dowel pin into the 8m hole of the above panels with an iron hammer. Please note that the hole of the three-in-one connecting rod should also be 8mm. The hole of the three-in-one connecting rod connects to the hole of 15mm three-in-one eccentric wheel.



HARDWARE LIST	
8*40mm wood dowel pins D  20PCS	

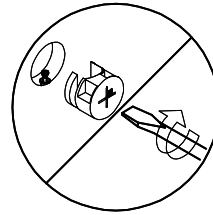
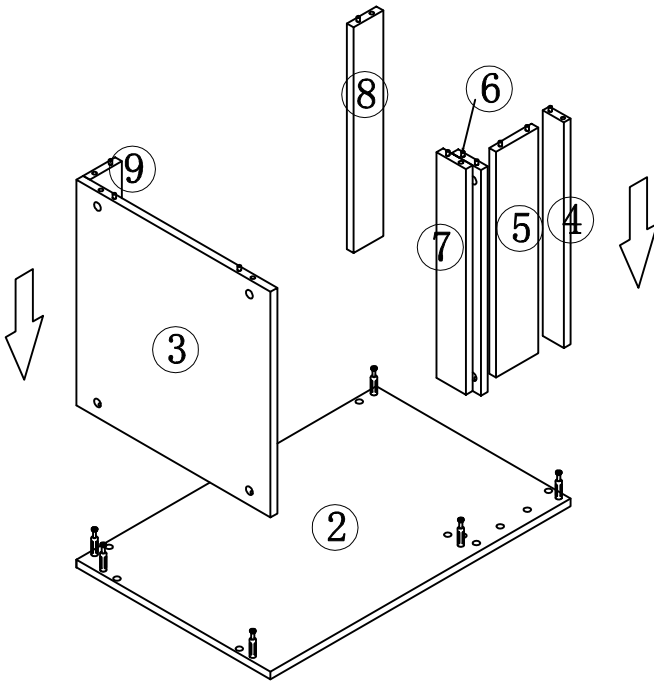

# STEP 3

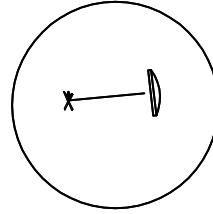

1. Connect No. 3-4-5-6-7-8-9 panel to No. 2 panel tightly with the three-in-one eccentric wheel.



2. Cover the mounting hole of the eccentric wheel with a three-in-one sticker.

HARDWARE LIST		
Three-in-one eccentric wheel A  6PCS	Three-in-one sticker C  6PCS	

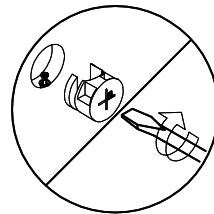
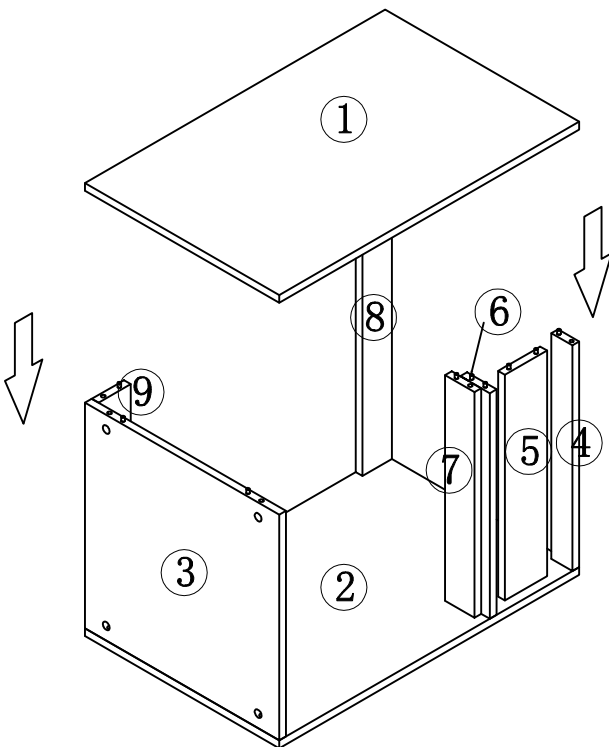

# STEP 4

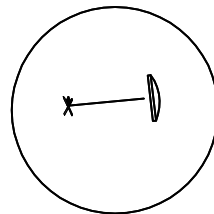

1. Connect No. 1 panel to No. 3-4-5-6-7-8-9 panel tightly with the three-in-one eccentric wheel.





2. Cover the mounting hole of the eccentric wheel with a three-in-one sticker.

HARDWARE LIST		
Three-in-one eccentric wheel A  6PCS	Three-in-one sticker C  6PCS	

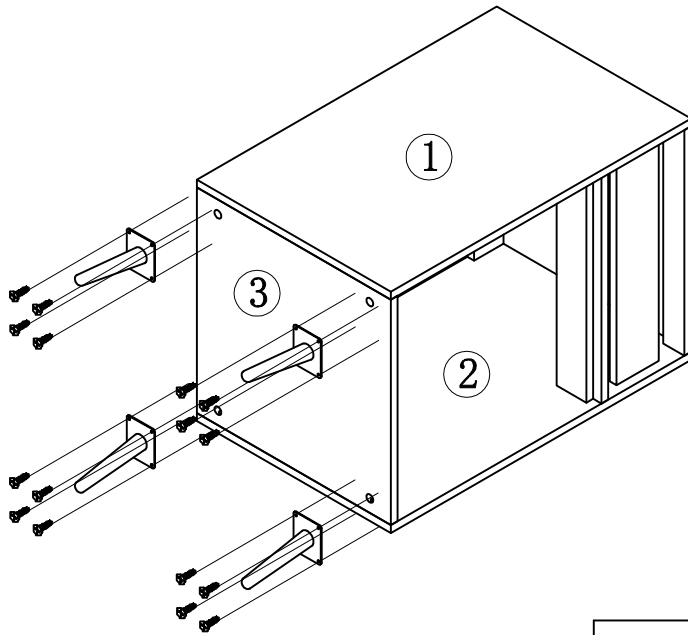
# STEP 5



Use 4\*16 screws to fix the Metal feet

HARDWARE LIST		
4*16mm screw	Metal feet	
G  16PCS	K  4PCS	

# STEP 6

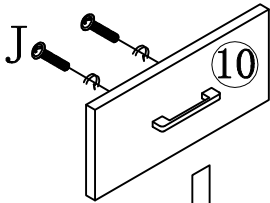

Install the door handle with 4\*18mm screws.

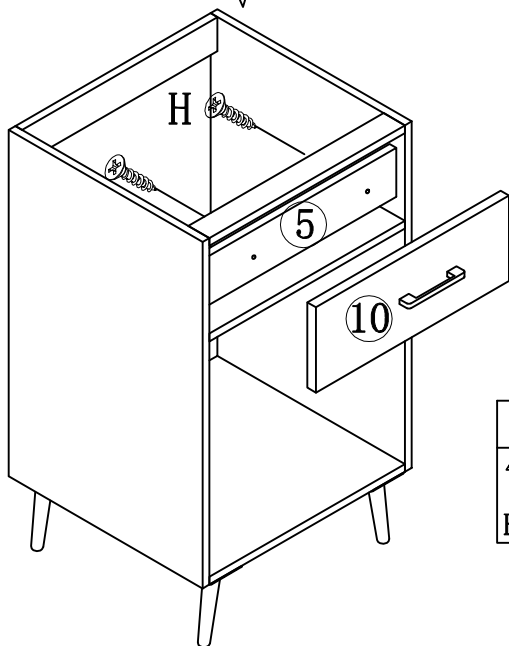

Use screws(H) to tightly connect the No.10 panel with the No.5 panel.

HARDWARE LIST			
4*30mm screw	4*18mm screw	Door handle	
H  2PCS	J  2PCS	F  1PCS	

# STEP 7

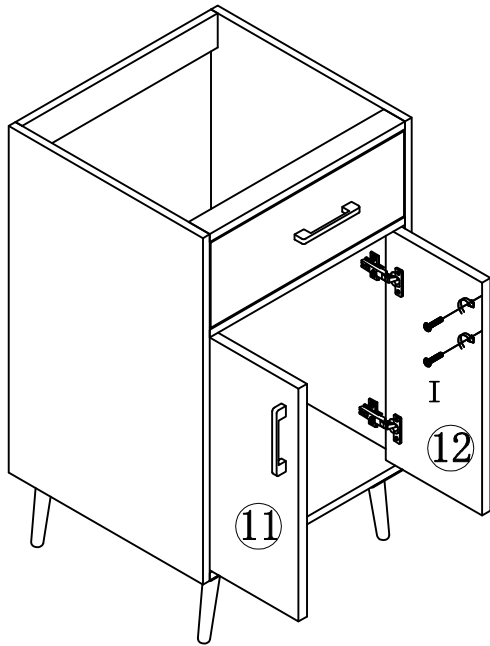

Install the Door handle with 4\*23mm screws.

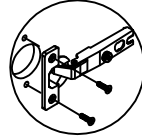

1. Install the hinge cup to the door panel with 4\*16mm screws.

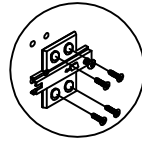

2. Install the hinge to the side panel with 4\*16mm screws.

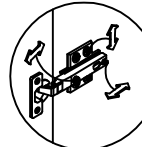

4. Adjust the door panel clearance.

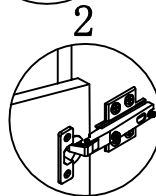
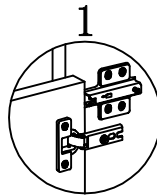

3. Install the hinge cup on the door panel to the hinge of the side panel.

HARDWARE LIST				
4*16mm screw	Door hinge	Door handle	4*23mm screw	
G  24PCS	E  4PCS	F  2PCS	I  4PCS	

## Hinge/Door Adjustment and Realignment

If adjustment or realignment is needed, follow the instructions provided in the following chart.

Vertical adjustment

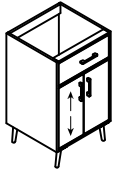

1. Loosen screws

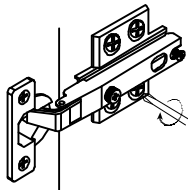

2. Adjust hinge

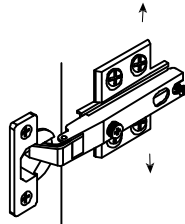

3. Tighten screws

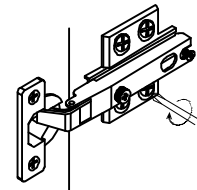

Horizontal adjustment

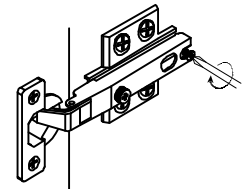
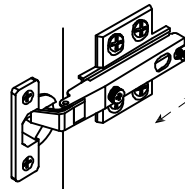
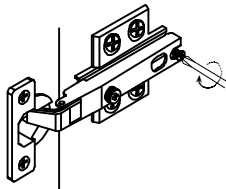

Door gap adjustment

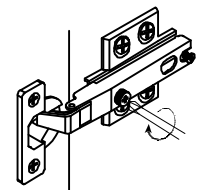
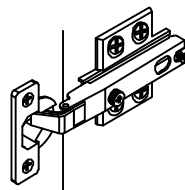
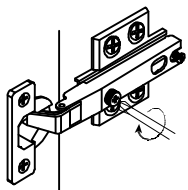



**Choking hazard-Small Parts :** This unit contains small parts, not for children under 3 years.

**Tip-over hazard :** Secure finished unit to wall stud using L-Bracket and wall screw (#10\*1.5"W/out provided). If a wall stud is not neccessible , Consault your local hardware store for appropriate mounting hardware . Failure to properly install will result in product collapse or tip-over. Serious injury can occur .