

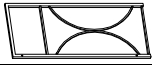













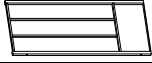









NO.	COMPONENT	QTY	NO.	COMPONENT	QTY
A		4	G		4
A1		4	H		4
B		4	I		1
B1		4	J	 M6x30	8
C		8	K	 M6x45	16
C1		8	L		24
D		8	M	 M6	24
D1		4	N		8
E		4	O	 M6	2
E1		4	P		1
E2		4	Q		4
F		4			
F1		4			

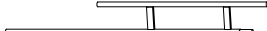

1.

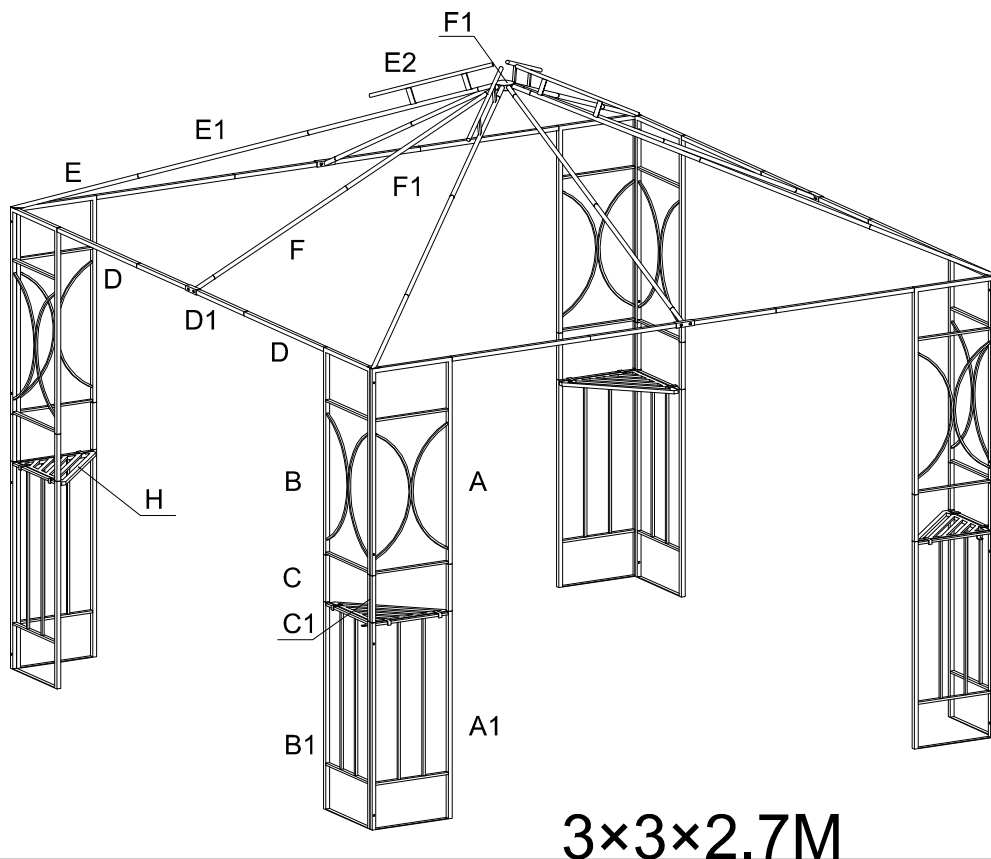
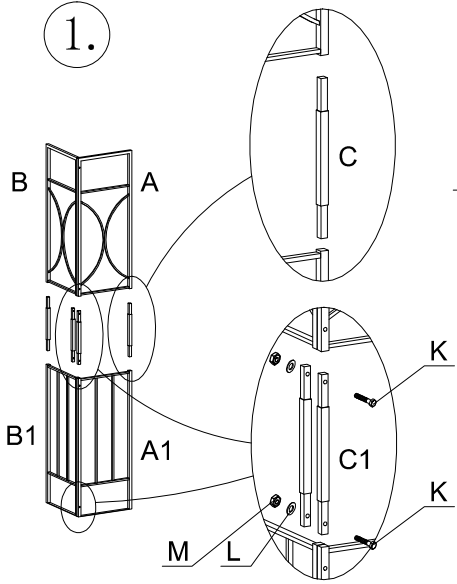

2.

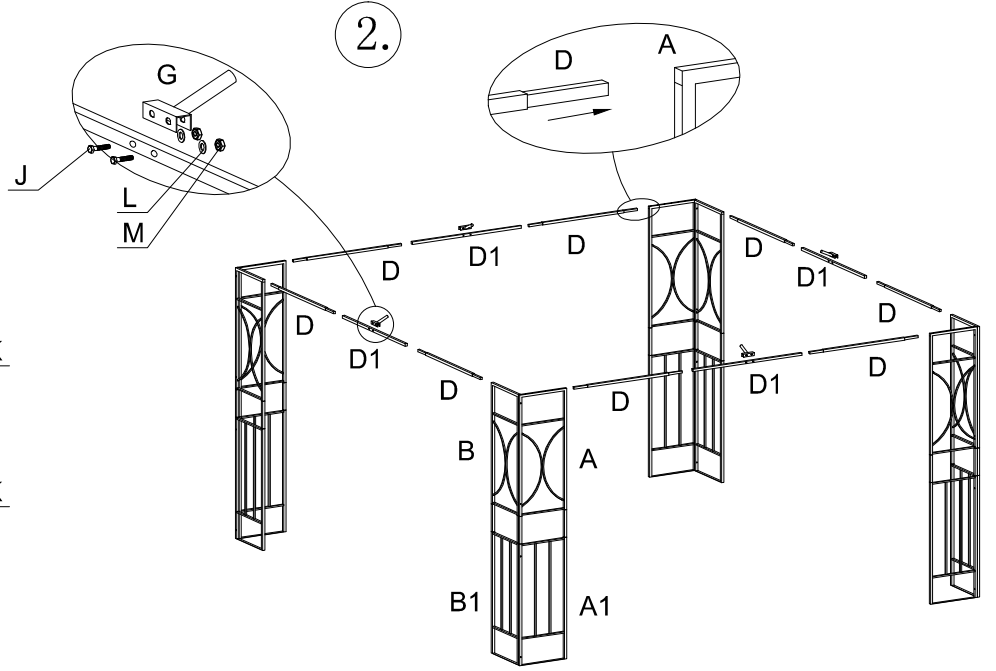

3.

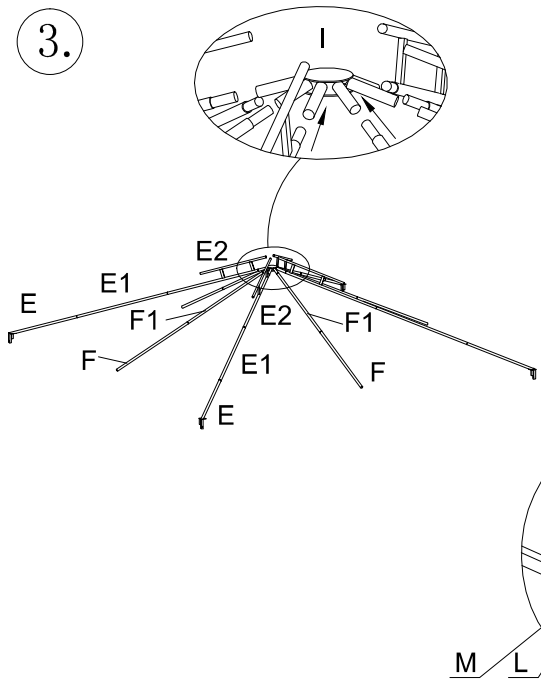

4.

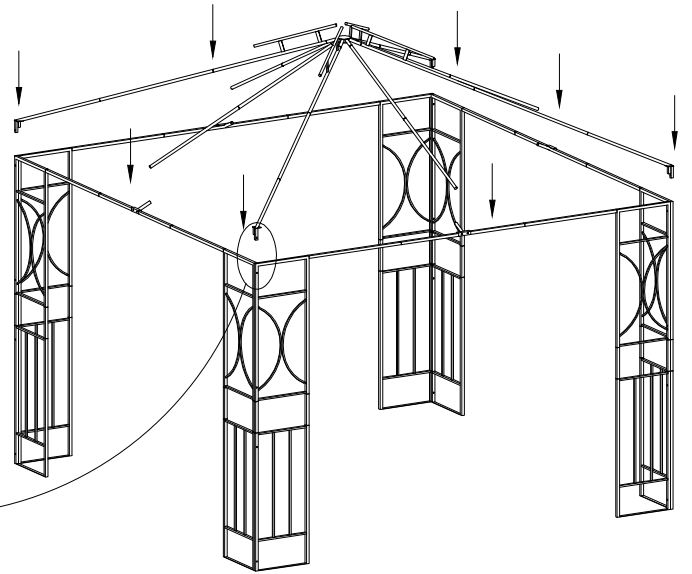

5.

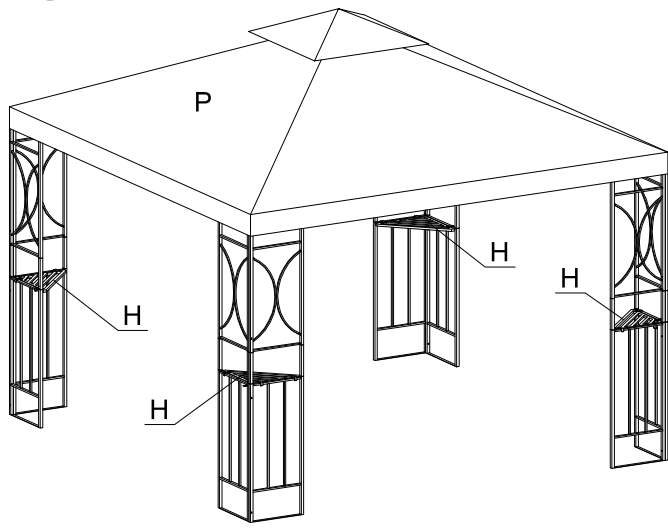

6.

