



















Hardware

Tools Required

Power tools NOT recommended

NO.	Quantity	Accessory
A	4	 Metal Bracket
B	12	 5x60 mm
C	32	 3.5x30 mm
D	12	 Screw 8X25 mm
E	3	 Center Leg
F	1	 Allen Wrench 5mm
G	2	 Headboard Leg
H	2	 Screw 8X45 mm
I	2	 Washer 8mm

NO.	Quantity	Accessory
A	4	 Metal Bracket
B	12	 5x60 mm
C	32	 3.5x30 mm Sc
D	12	 rew 8X25 mm
E	3	 Center Leg
F	1	 Allen Wrench 5mm
G	2	 Headboard Leg
H	2	 Screw 8X45 mm
I	2	 Washer 8mm

King Bed

Queen Bed

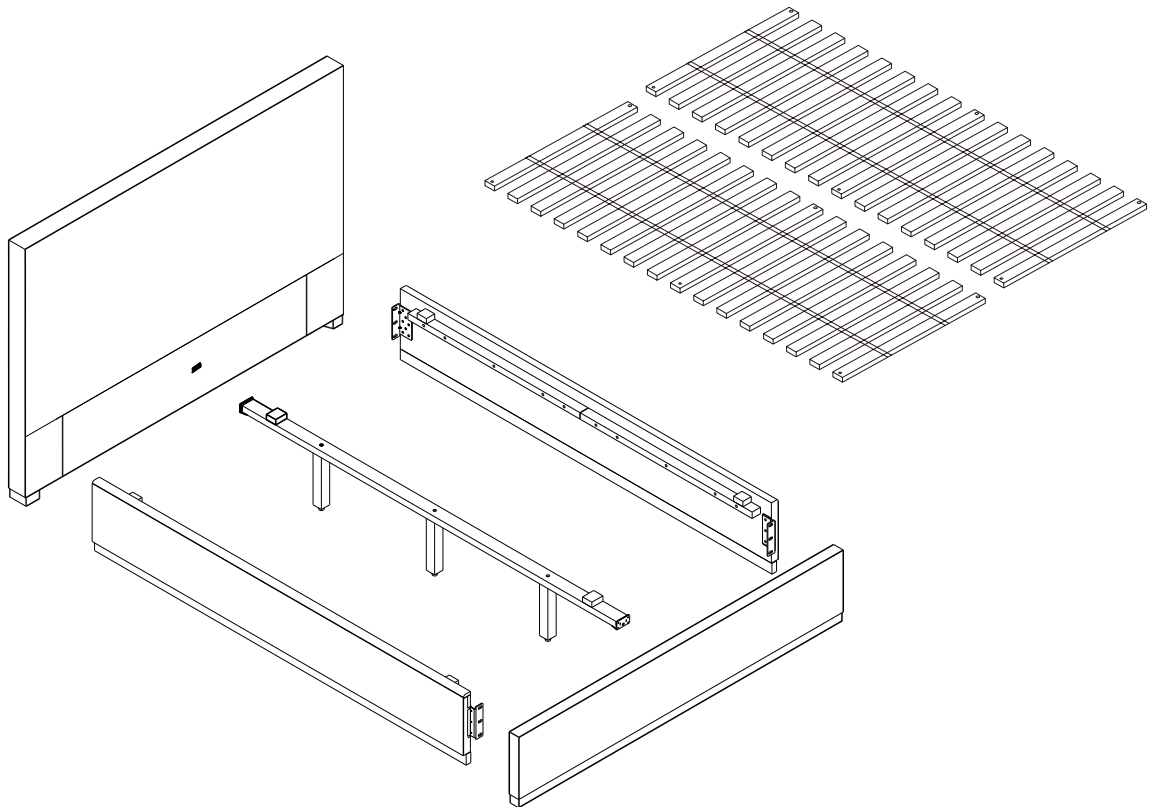

- 1) Place the headboard upright.
- 2.) Attach Leg (G) by inserting screw (H) with washer (I) into the pre-drilled hole and tighten securely using Allen wrench (F).
- 3). Align the left and right side rails with the connection points on the headboard and footboard.
- 4). Use the provided metal brackets (A) to join the side rails to the headboard and footboard. Use screws (C) and bolts (D) to secure, fully tighten the connection.

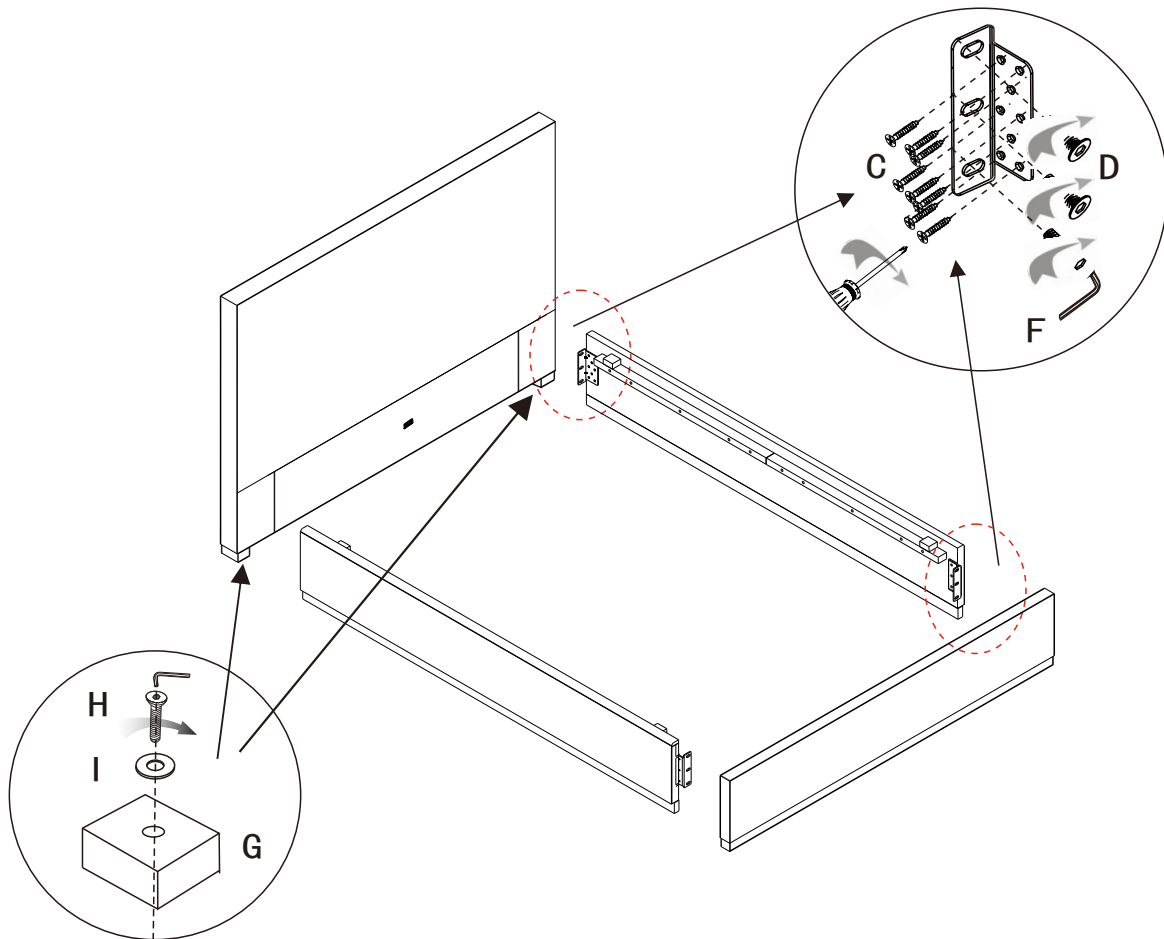

Hardware

Tools Required

Power tools NOT recommended

- 2) 1). Insert the 3 support legs (E) into the designated holes along the underside of the center rail.
- 2). Twist each leg to adjust the height and ensure all legs are at the same level for even support.

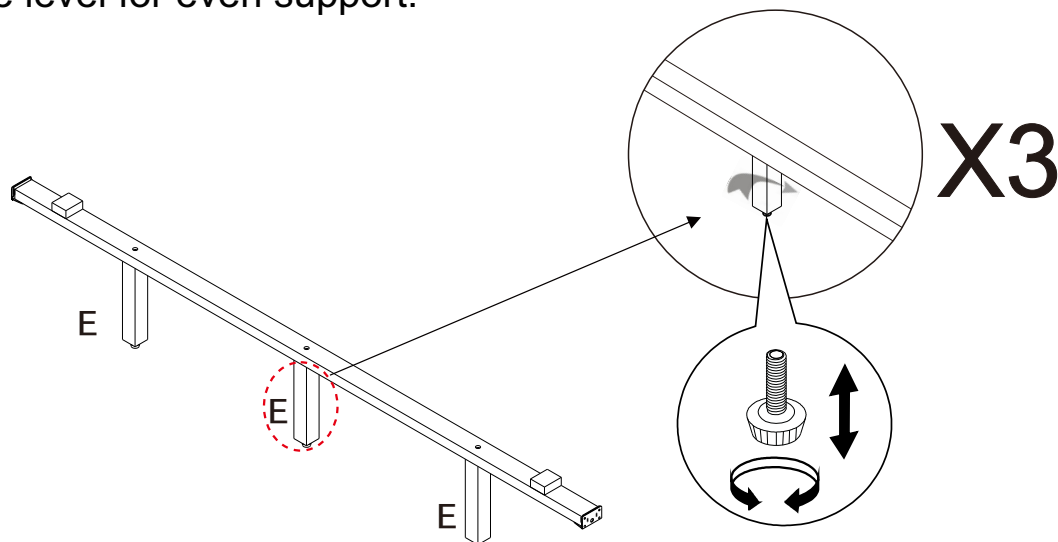

- 3) 3) Position the center support rail between the side rails and attach each end of the center rail to the brackets on the side rails.

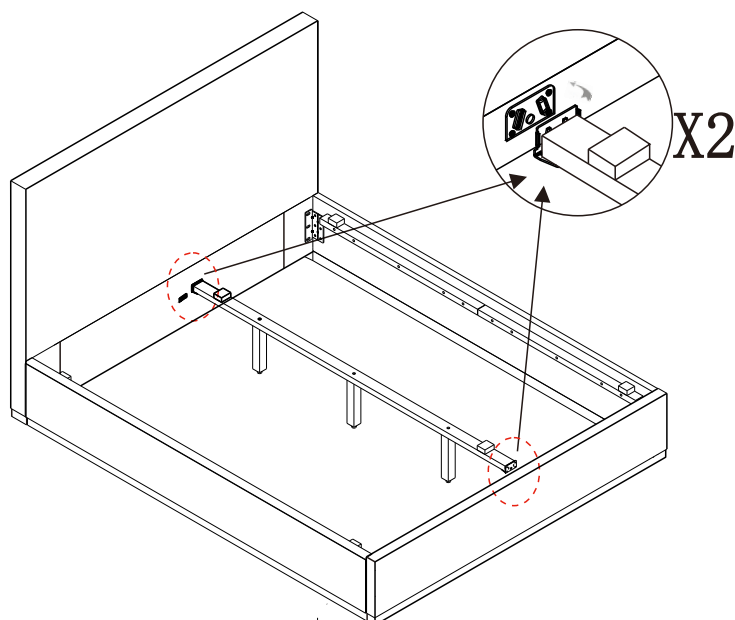

- ④ 1). Place the slats evenly across the bed frame.
- 2). Secure the slates using the screws (B).
- 3). The bed is fully assembled and ready to use.

