

CARE AND MAINTENANCE

Dust with a soft, dry cloth. Do not use abrasive cleaner. To clean mirror, spray a small amount of glass cleaner onto a lint-free cloth and wipe mirror clean

NOTICE







*Please make sure that you have all parts indicated before you begin assembly of this item

*This item should be assembled on a surface to prevent scratching the finish during assembly

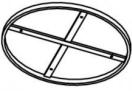
*This item may require periodic tightening

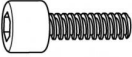
Product Dimension: dia31.5"*28.3"H

Part List and Hareware List

PIECE	DESCRIPTION	PICTURE	QUANTITY
A	GLASS		1X
B	TABLE TOP		1X
C	LEG-1		1X
D	LEG-2		1X
H1	ALLEN BOLT		4X
H2	SPRING WASHER		4X
H3	FLAT WASHER		4X
H4	ALLEN KEY		1X



PREPARATION

Before beginning assembly of product, make sure all parts are present. Compare parts with package contents list and hardware contents list.

If any part is missing or damaged, do not attempt to assemble the product.

Estimated Assembly Time: 8 minutes.

Tools Required for Assembly (included): Allen Key

1

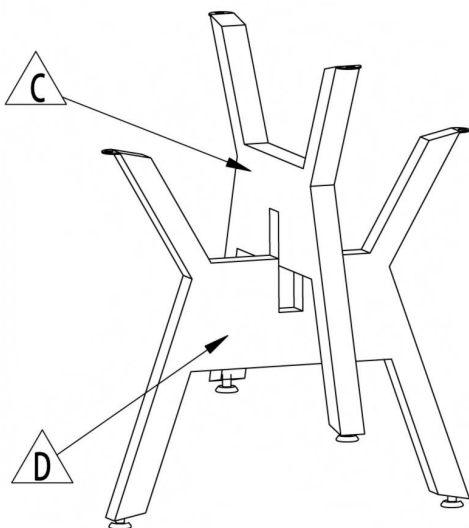

2

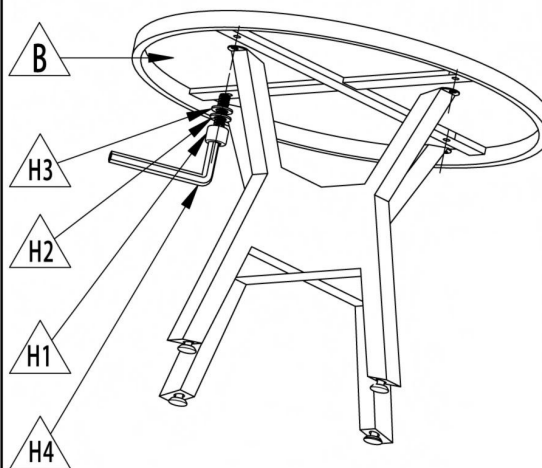

3

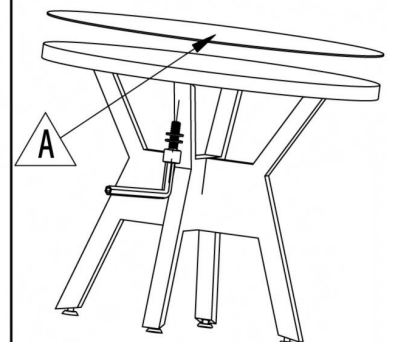

Step1

Use LEG-1 (D) LEG-2 (C)
Two legs are at a 90
degrees cross together

Step2

Make sure the hole of Table
top (B) and hole of LEG-1 (D),
LEG-2 (C) are aligned
Using allen bolt (H1) spring
washer (H2), flat washer
(H3), Tighten with allen key (H4)

Step3

Put the glass (A)
on the table