

ASSEMBLY INSTRUCTIONS

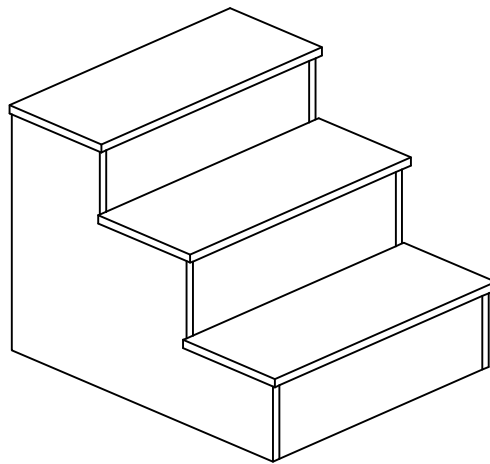

NOTE TO CUSTOMERS:

- For ease and speed of assembly we recommend that before you commence each step of the assembly that you identify all the parts required to complete that step.
- We recommend that where possible you allow sufficient space to assemble the item as close as possible to the place where it will be once assembled.
- For the protection of your furniture we recommend that the product is placed on protected surfaces during assembly to prevent any damage.
- During assembly do not over tighten, as this may damage the product.
- Please ensure you retain all the product packaging until the item completely assembled.
- Please periodically check all fittings and re-tighten as necessary.
- Please never allow any liquids to remain on your furniture as absorption can cause the wood to warp or finish to de-laminate.
- It is recommended that this item should be assembled by two adults.

To use a cam lock: (Please read below instructions before assembling)

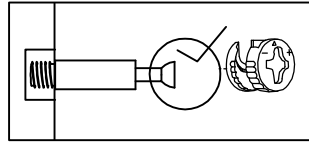
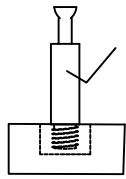

1. Insert cam screw into hole as shown in diagram A .

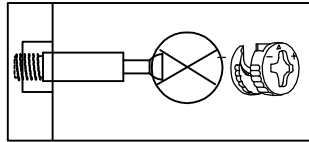
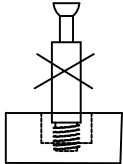

Diagram B

Make sure not to insert the cam screw:
Too deep as shown in figure B as this will cause the
cam screw to be misaligned and unable to
interlock properly.

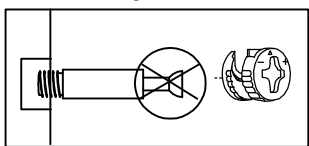
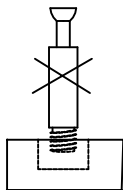
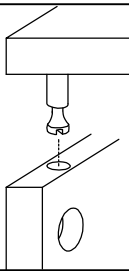
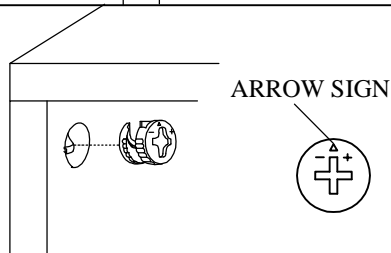

Diagram C

Also avoid inserting the cam screw too close to the
surface of the hole as shown in figure C, as this will
cause the cam lock to be too loose, and not interlock
properly.



2. Connect the panels together.



3. When inserting the cam lock make sure the arrow
of the cam lock faces the cam screw.

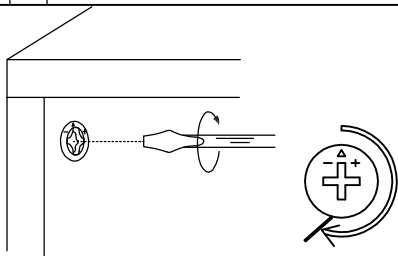

4. To tighten the cam lock turn the cam lock clockwise
90-180 degree or until the arrow is facing opposite
the place cam lock was inserted.

**NOTE: DO NOT USE AN AUTOMATIC
SCREWDRIVER TO TIGHTEN CAM LOCKS.**

Note:

- Read these instructions carefully before assembling.
- Tools required : Phillips screwdriver, flat screwdriver.
- Find a clean, smooth area on which to work , such as a carpet, in order to avoid scratching the wood surfaces.
- Wait to dispose of the packing material until assembly is complete and all parts and hardware are accounted for.
- Two or more people might be required for assembly.
- Max weight capacity 200 lbs.

Furniture Parts

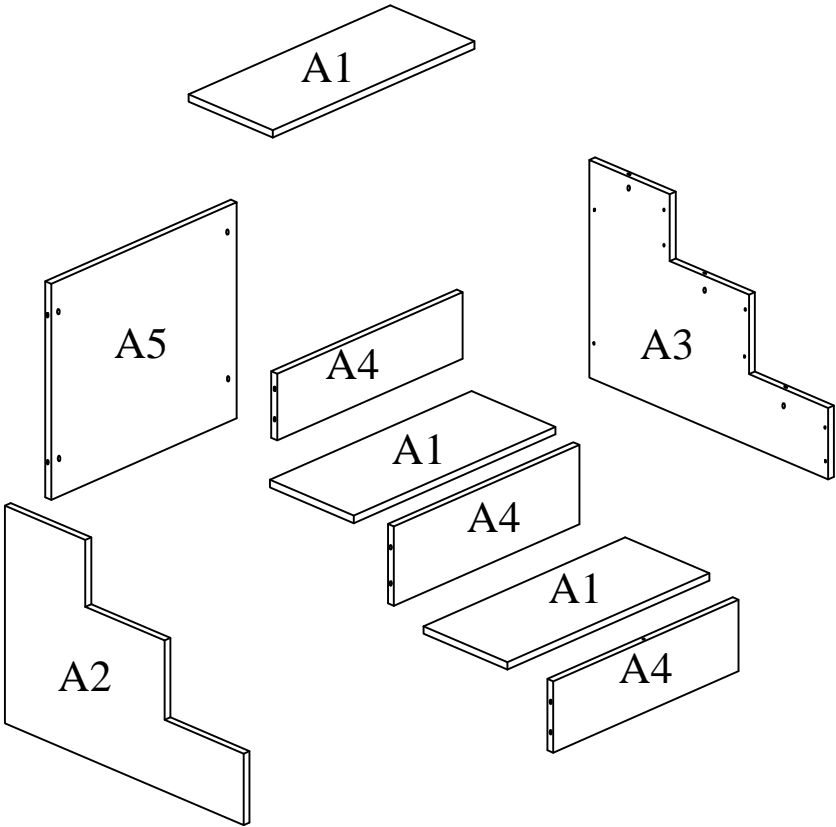

Furniture Parts

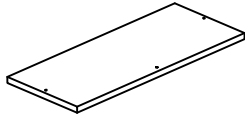

A1 3PCS- Top Panel

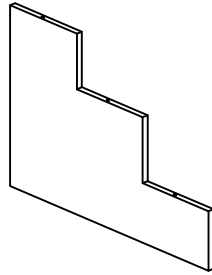

A2 1PC-Side Panel

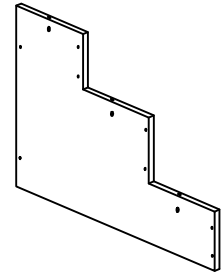

A3 1PC-Side Panel

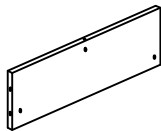

A4 3PCS-Front Panel

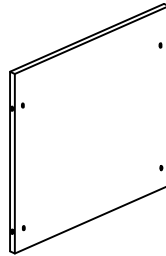

A5 1PC-Back Panel

Hardware List

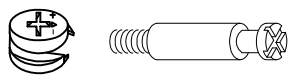

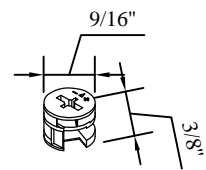
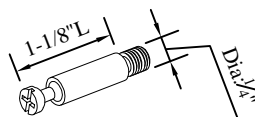

B1 19SETS-Camlock

B1-size



B2 6PCS-Wood Dowel

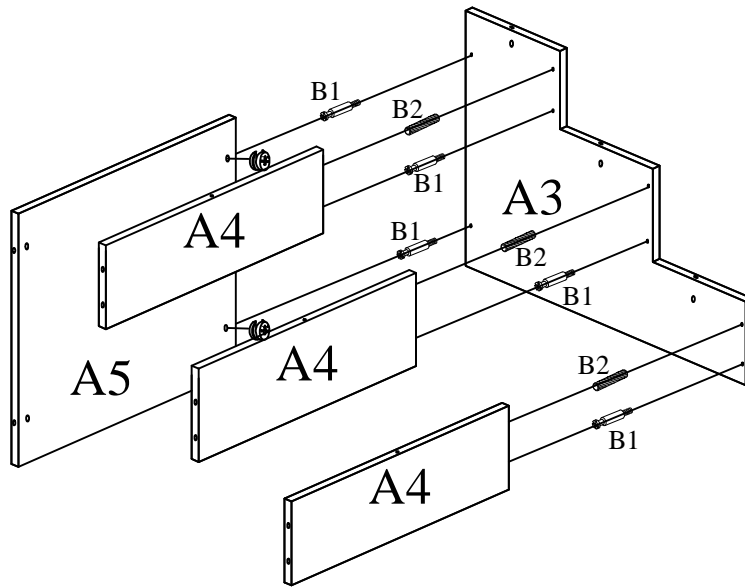

Step 1

B1		5SETS
B2		3PCS



Assemble Front panels A4 and Back Panel A5 to Side Panel A3 using Cam-locks B1 and Wood Dowels B2.

Step 2

B1		5SETS
B2		3PCS

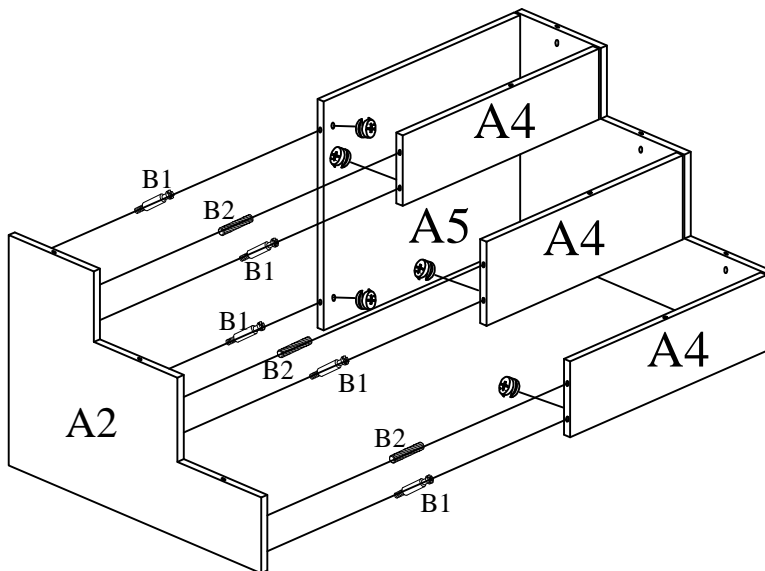

Assemble Front Panels A4 and Back Panel A5 to Side Panel A2 using Cam-locks B1 and Wood Dowels B2.

Step 3

B1  9SETS

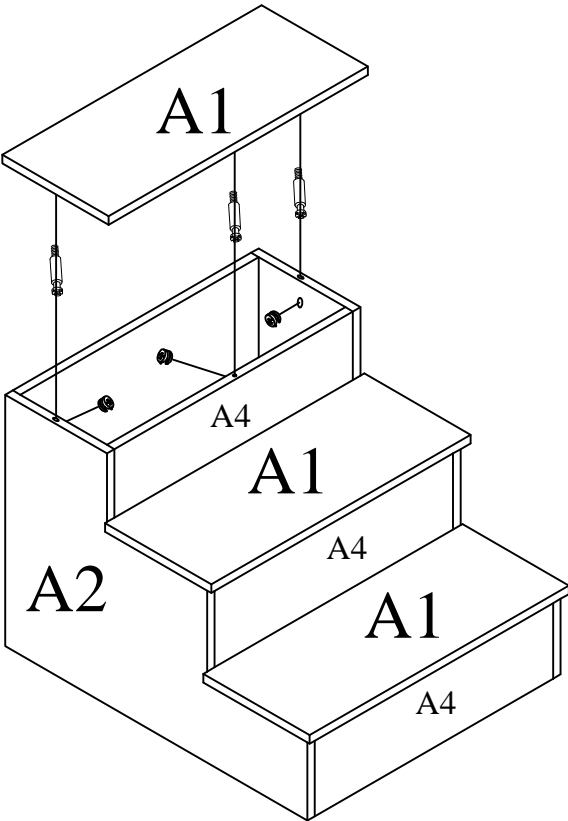

Assemble Top Panel A1 onto Side Panels A2&A3 and Front Panel A4 using Cam-locks B1.