

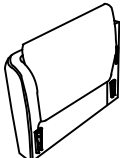

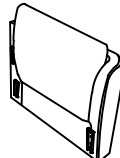

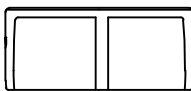
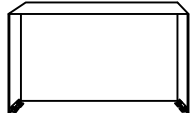
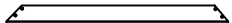

# Accessories list(sitting sofa)

<p>A</p>  <p>Right armrest(1)</p>	<p>B</p>  <p>Left armrest(1)</p>	<p>C</p>  <p>Backrest(1)</p>	<p>D</p>  <p>Seat frame(1)</p>	<p>E</p>  <p>Seat frame side panel(1)</p>	
<p>F</p>  <p>Seat cushion(2)</p>	<p>G</p>  <p>Back Cushion(2)</p>	<p>H</p>  <p>12cm Sofa feet(4)</p>	<p>I</p>  <p>16mm Screw(4)</p>	<p>J</p>  <p>6*16 Gasket(4)</p>	<p>K</p>  <p>M4*65*23 Wrench(1)</p>

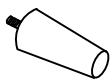
## STEP 1:

Install hardware for sofa seat frame

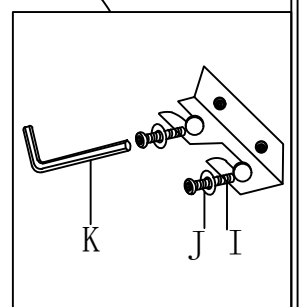
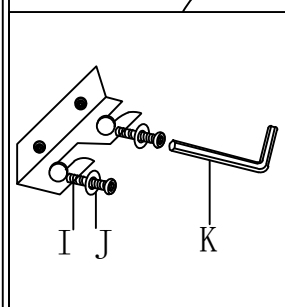
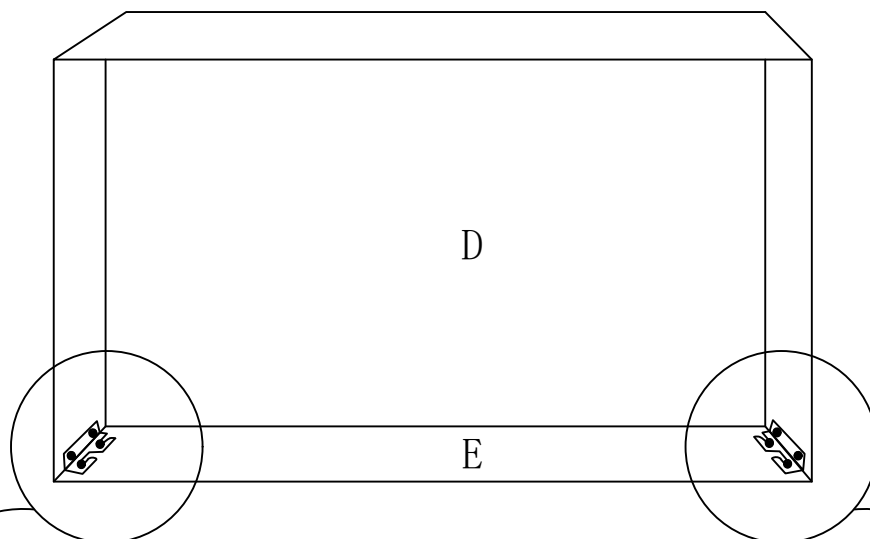

STEP 2:

Insert the seat frame into the left armrest

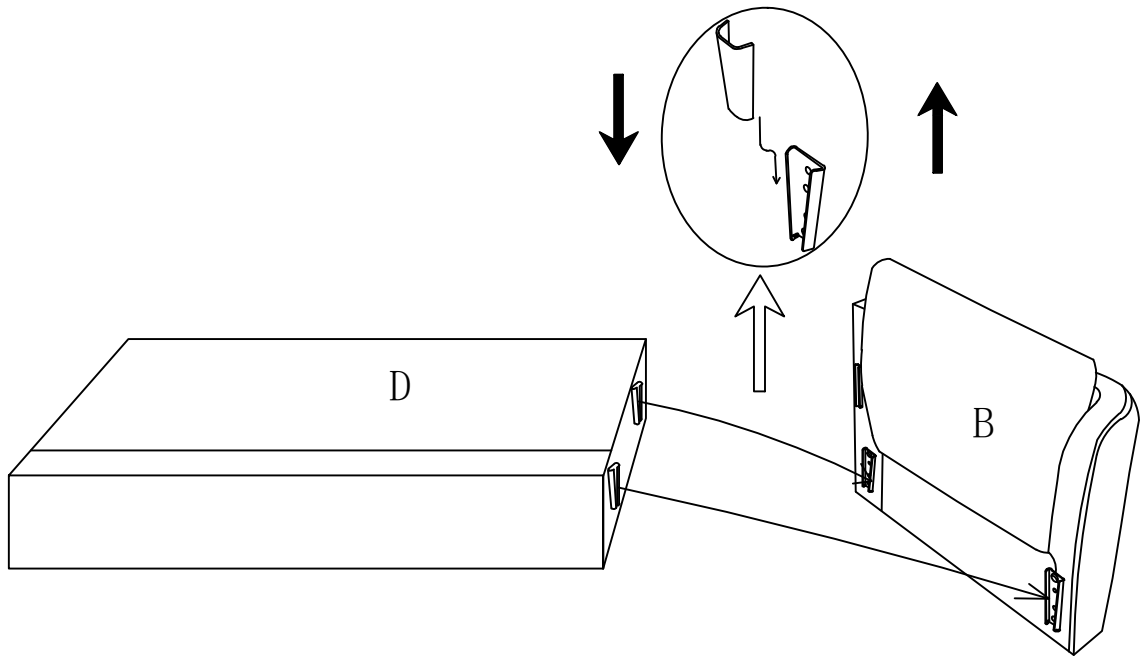

STEP 3:

Insert the seat frame into the right armrest

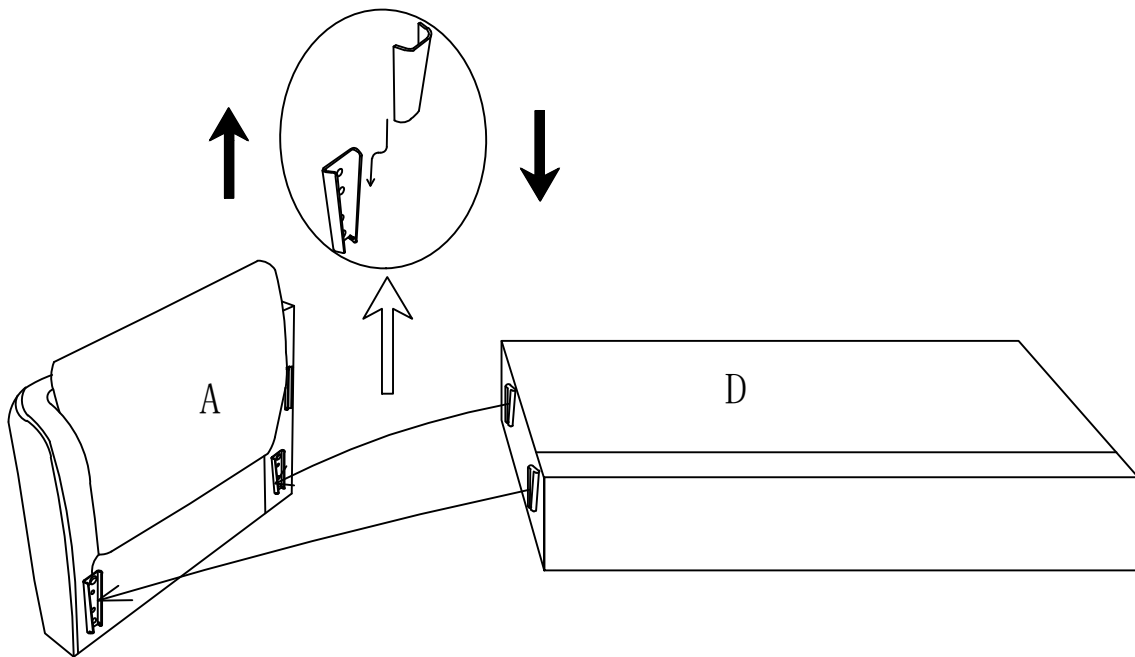

STEP 4:

Insert the backrest into the seat frame

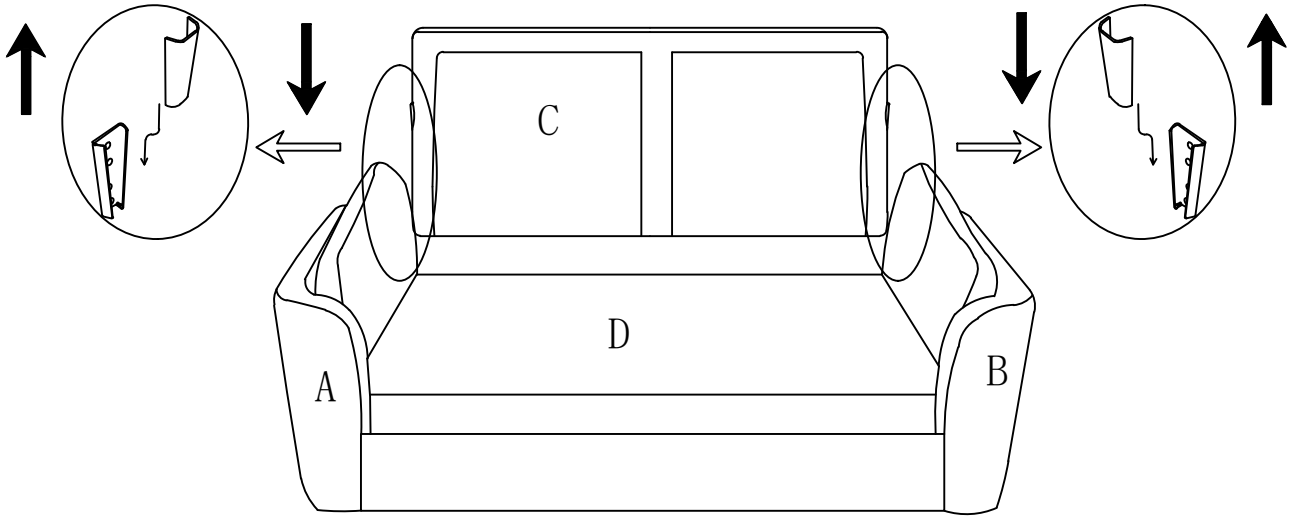

STEP 5 :

Install the sofa feet

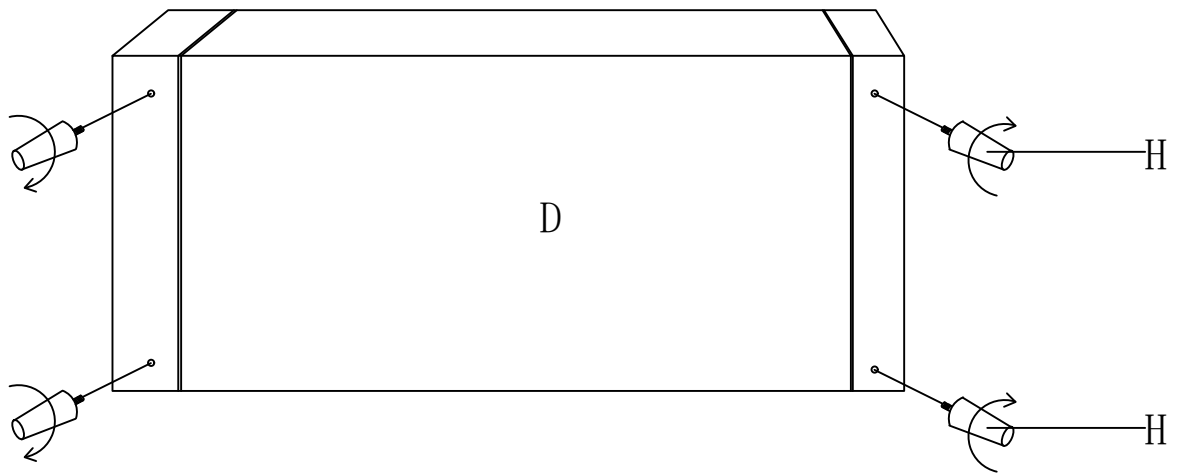

STEP 6:

Cut the compression bag

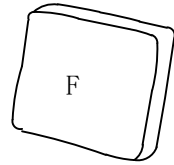
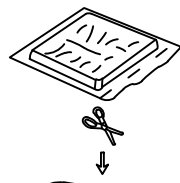

Seat cushion\*2

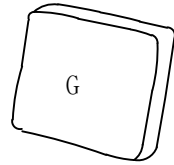
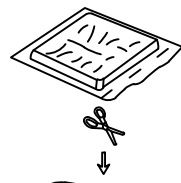
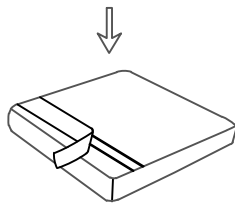

Back Cushion\*2

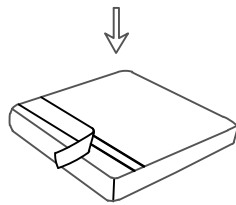

STEP 7 :

Assembly completed

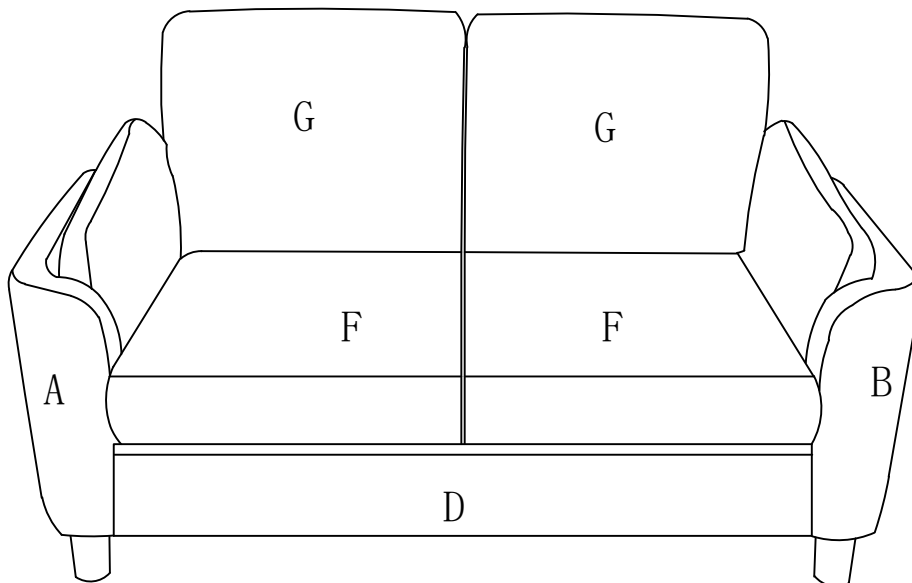

Sofa feet and hardware are placed  
in the sofa seat frame

