

Assembly Instruction

Space Saving Multimedia Storage Tower

00:30

Approx. 30 minutes





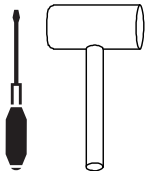

Recomm. 1 Person

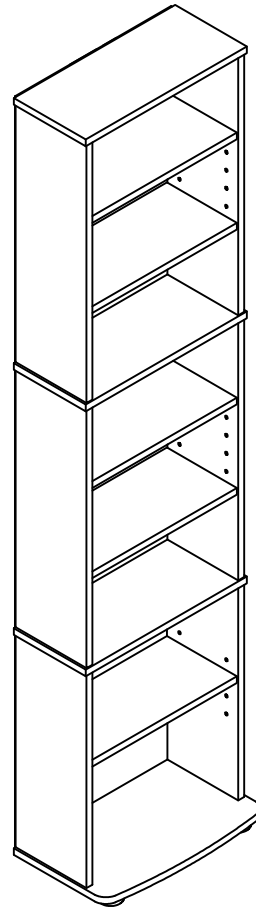

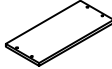

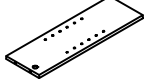
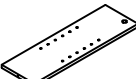

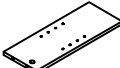

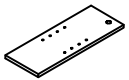
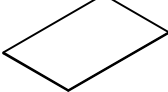
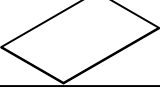
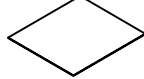
Tool Required



NO	PARTS LIST	QTY
A	TOP PANEL 	1pc
B	CENTER PANEL 	2pcs
C	LONG LEFT SIDE PANEL 	2pcs
D	LONG RIGHT SIDE PANEL 	2pcs
E	SHELF PANEL 	5pcs
F	BOTTOM PANEL 	1pc
G	SHORT LEFT SIDE PANEL 	1pc

NO	PARTS LIST	QTY
H	SHORT RIGHT SIDE PANEL 	1pc
I	TOP BACK PANEL 	1pc
J	CENTER BACK PANEL 	1pc
K	BOTTOM BACK PANEL 	1pc

NO	HARDWARE LIST	QTY
1	MINIFIT + HOUSING  1a 1b	6sets
2	C/B SCREW 	8pcs
3	DOWEL 	6pcs
4	SHELF SUPPORT 	20pcs
5	PLUG WITH LEG 	4pcs
6	POWER PIN 	30pcs
7	FURNITURE TIPPING RESTRAINT KIT  x2	1set

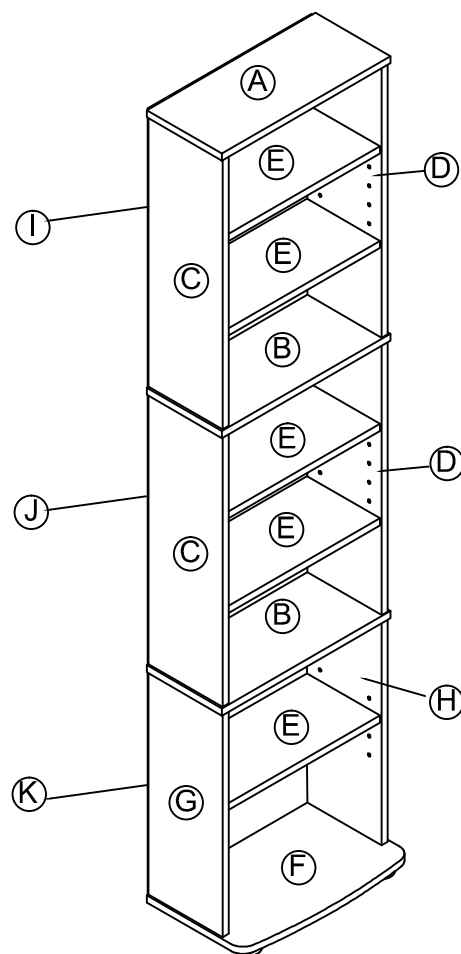

USEFUL HINTS BEFORE YOU START:

1. Read each step carefully before starting.
2. It is important that each step is performed in correct order to avoid difficulties.
3. Identify, sort and count the parts before assembly.
4. Assemble your furniture on packaging cardboard to prevent scratch or damage.
5. Clean the product with mild cleanser using soft damped cloth. Do not use harsh or abrasive cleanser.
6. Using incompatible hardware might cause damage to product.

ASSEMBLY INSTRUCTION

STEP : 1

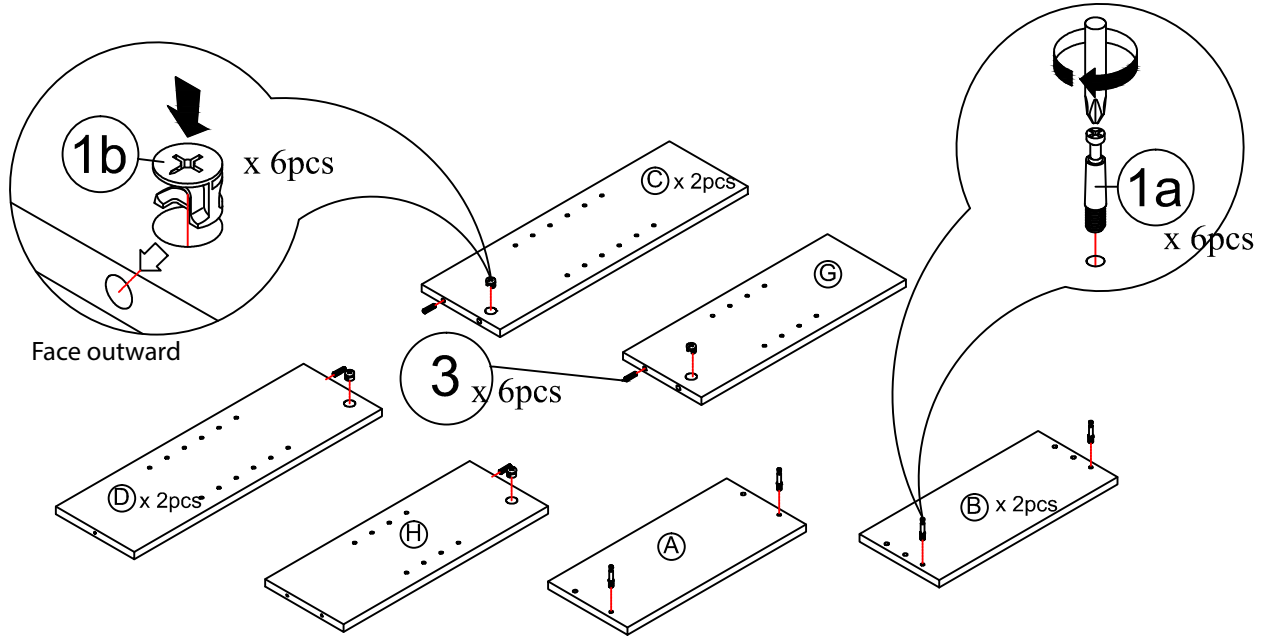

STEP : 2

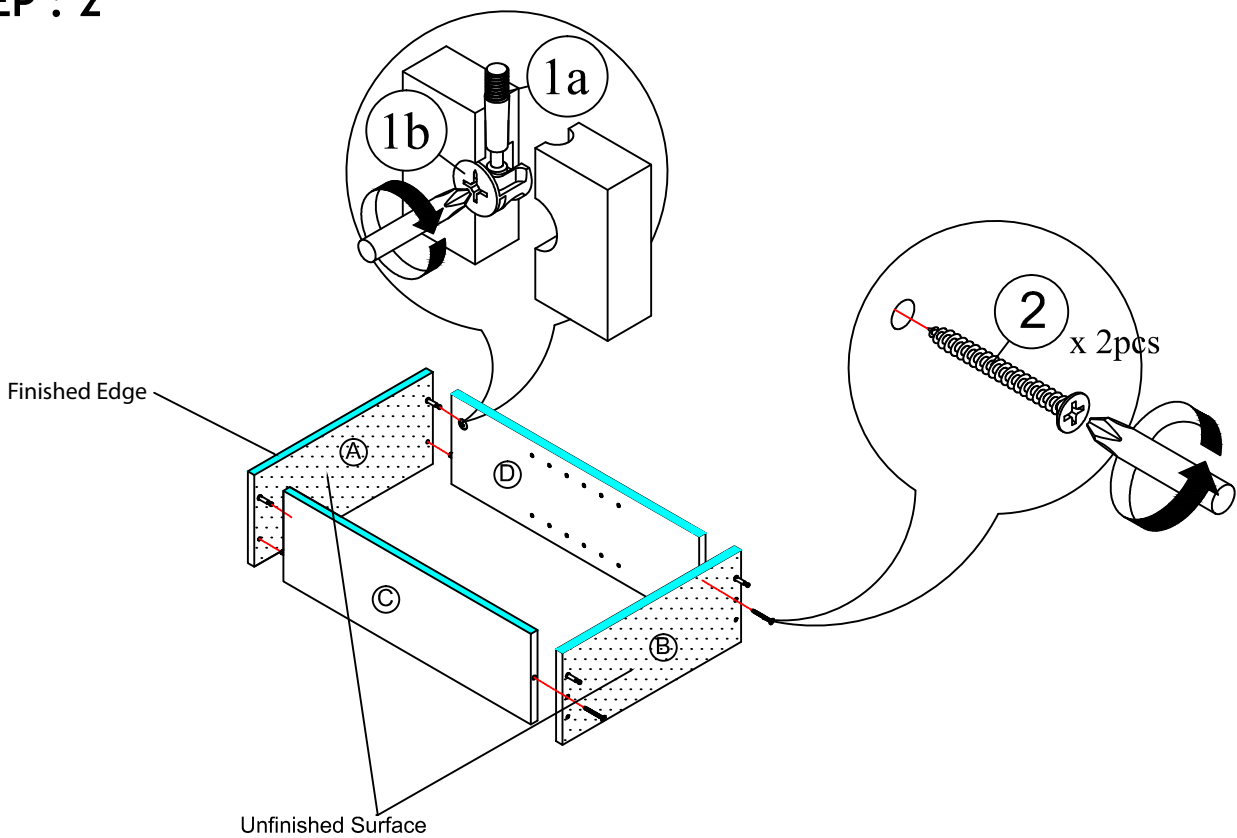

STEP : 3

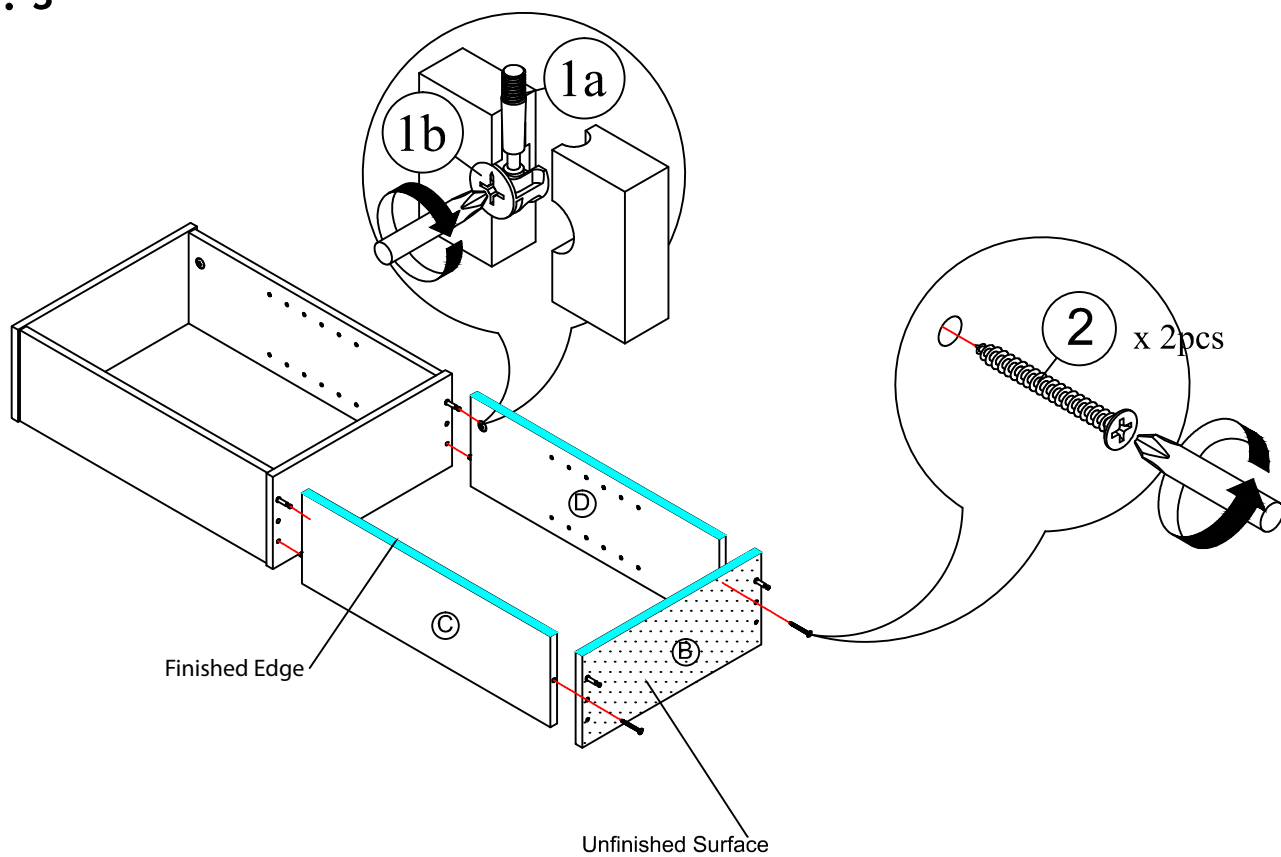

STEP : 4

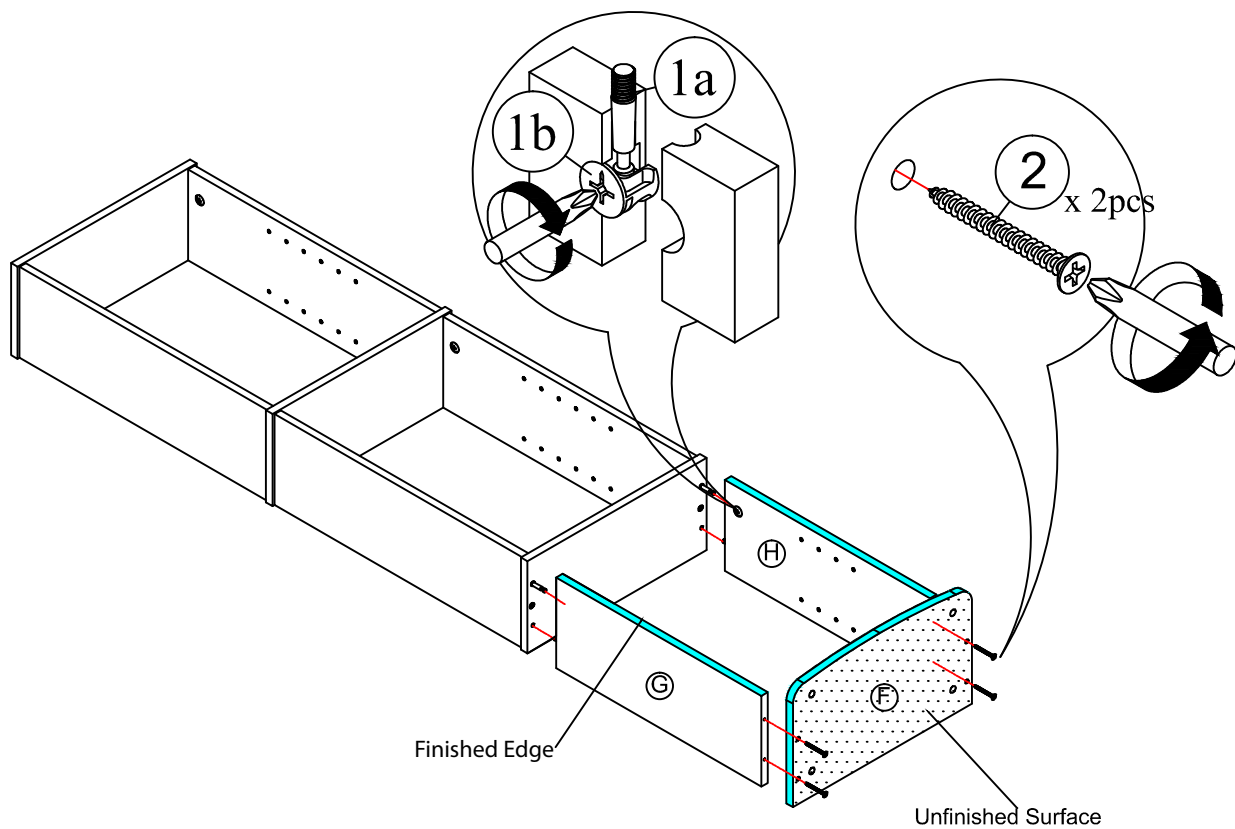

STEP : 5

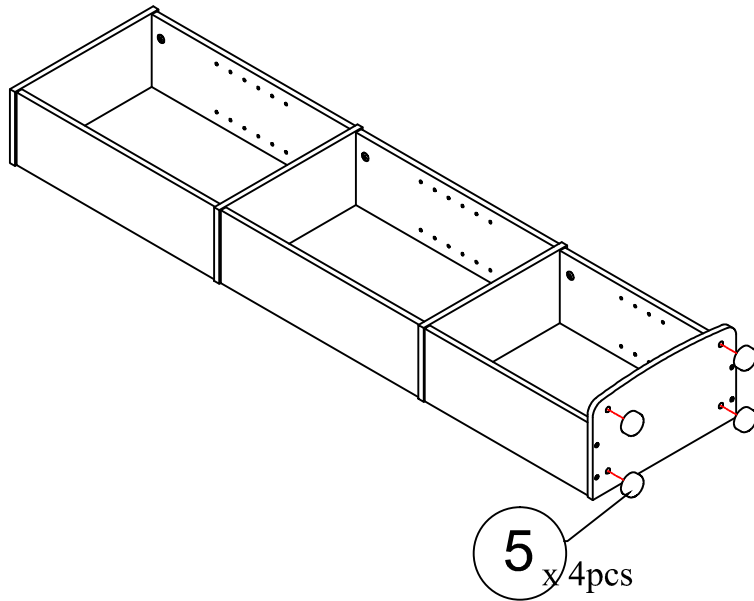

STEP : 6

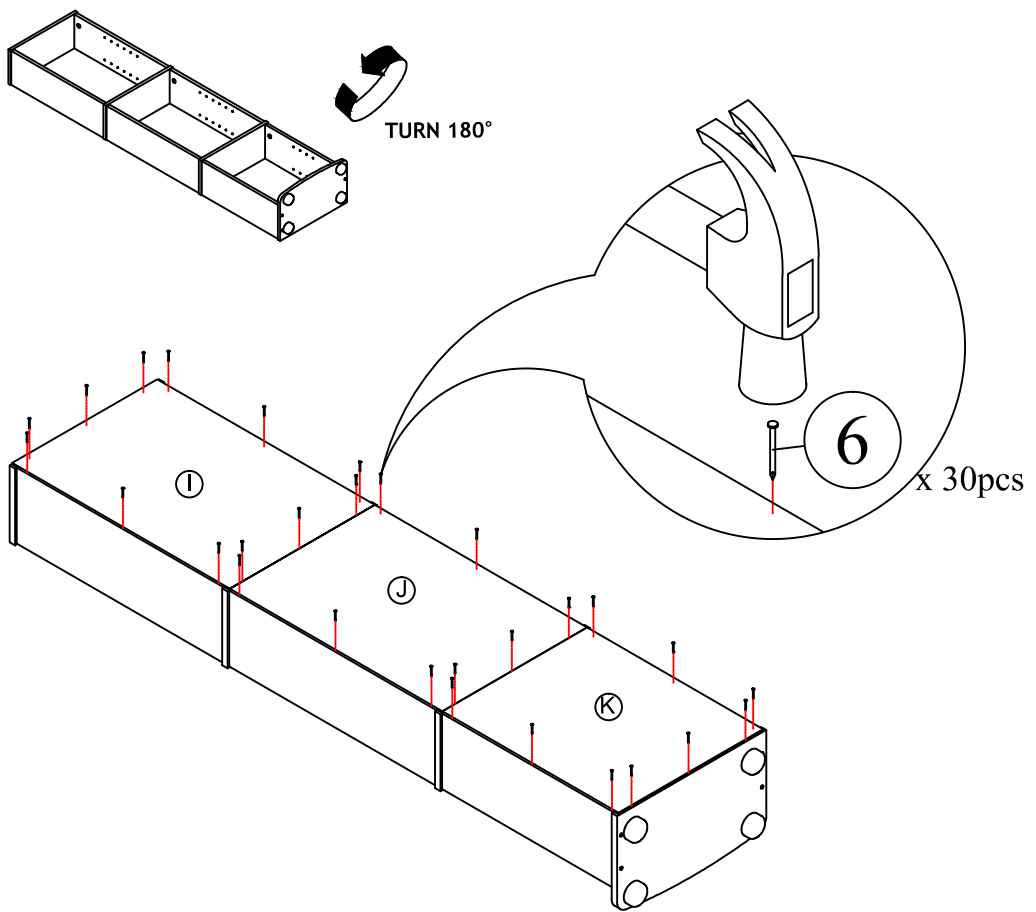

STEP : 7

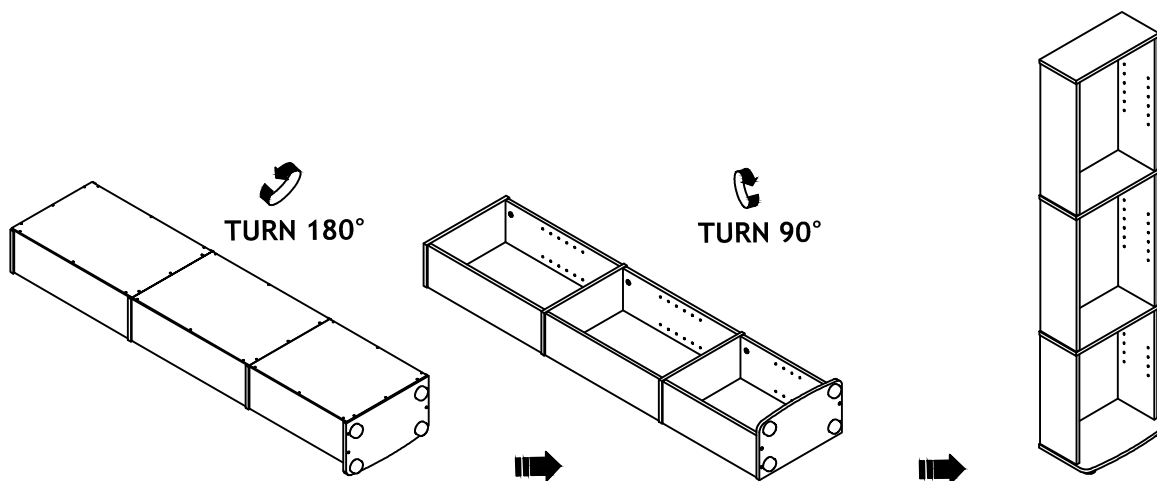

STEP : 8

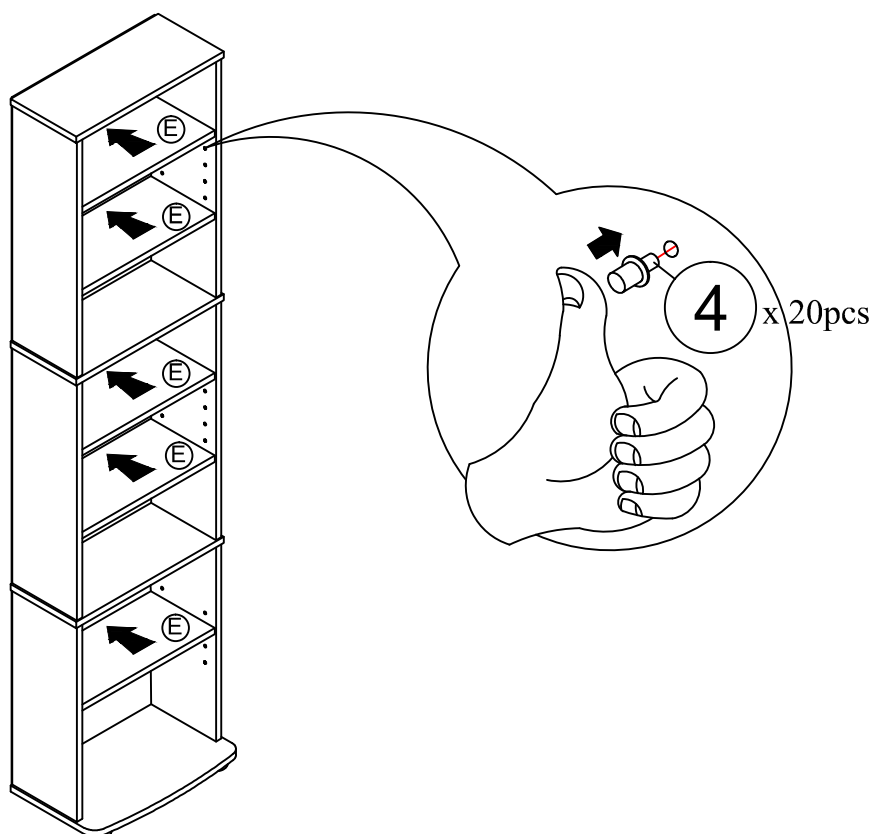

STEP : 9

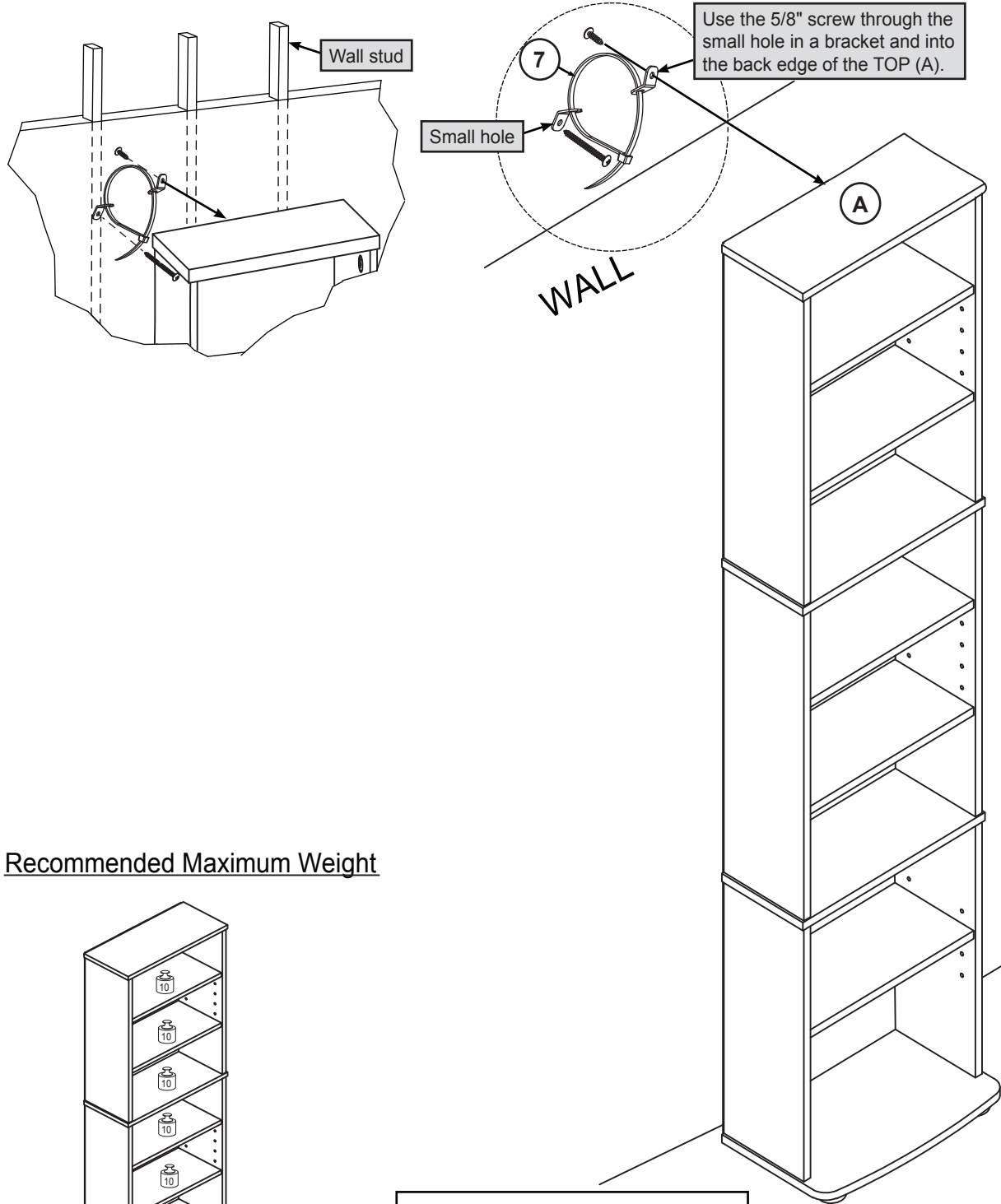

Recommended Maximum Weight

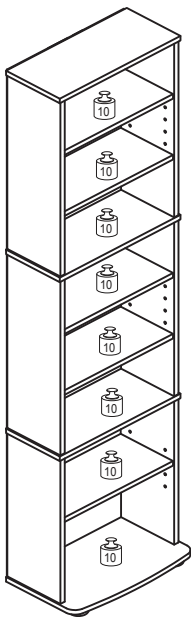

*Unit in Pound(lbs)

WARNING:

- >This unit has been designed to support the maximum loads shown. Exceeding these load limits could cause sagging, instability, product collapse, and/or serious injury.
- >DO NOT allow children to climb on unit.
- >Put heavier items on lower shelves.