

Assembly Instruction

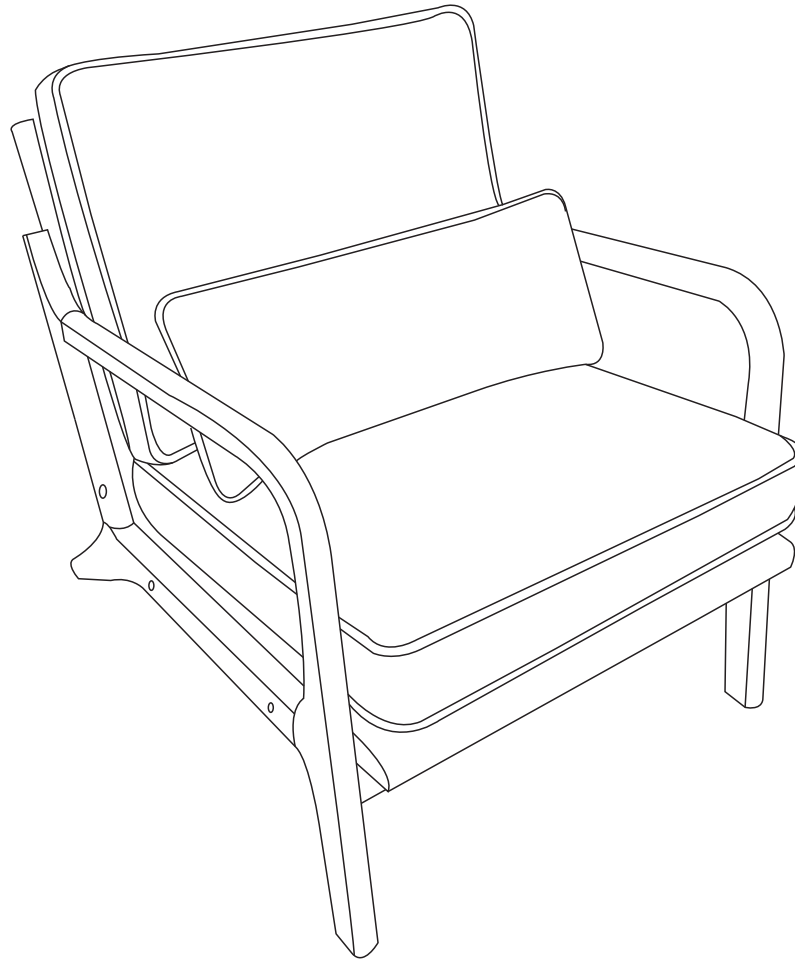

Attention: Do not open the compression bag if you are not satisfied with the product

Thank you for your purchase.

If you have difficulty with assembly or find a part is missing or damaged, please don't hesitate to contact us for solution.

Customer Service team will work hard to put a smile back on your face.

Components

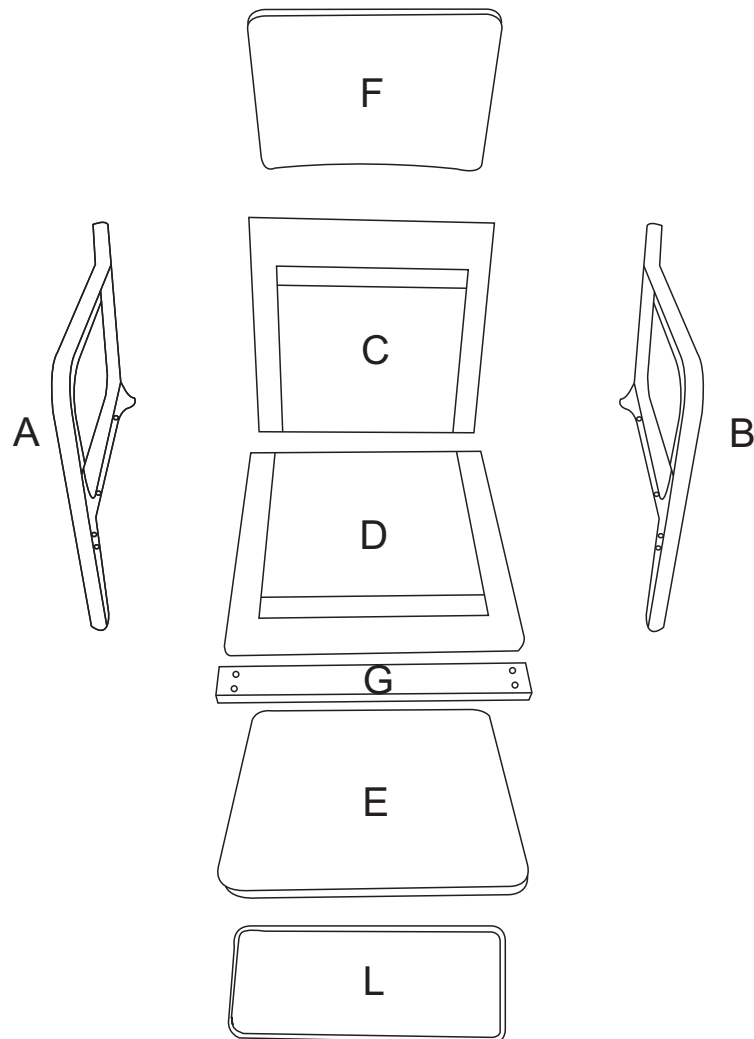

Attention:

Please be careful not to mix up the left and right legs by distinguishing the labels on the outer part of the wood











Left&right Legs assembled in reverse

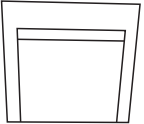
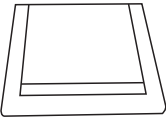
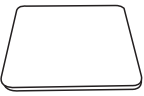

Left&right Legs assembled Correct

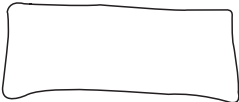

NO	PARTS	QTY	DESCRIPTION
A		1 PC	Left Arm-rest frame
B		1 PC	Right Arm-rest frame
C		1 PC	Back frame
D		1 PC	Seat frame
E		1 PC	Seat Cushion
F		1 PC	Back Cushion
G		1 PC	Crosspiece
H		8 PCS+1	M8*45mm Screw
I		4 PCS+1	M8*60mm Screw
J		1 PC	Allen Key
K		12 PCS+1	Cork
L		1 PC	Waist pillows

STEP 1

Connect Arm A/B to Crosspiece G with screw I

Note: screw should only be 70% tight

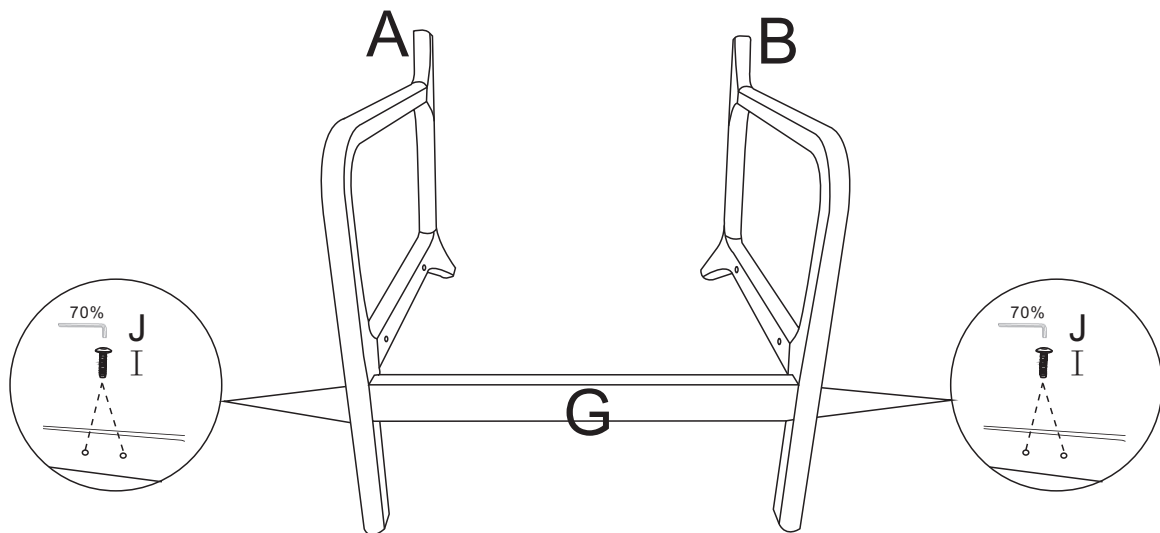

STEP 2

Connect Seat frame D to Arm A/B with screw H
(Install the screws near the front of the seat first)

Note: screw should only be 70% tight

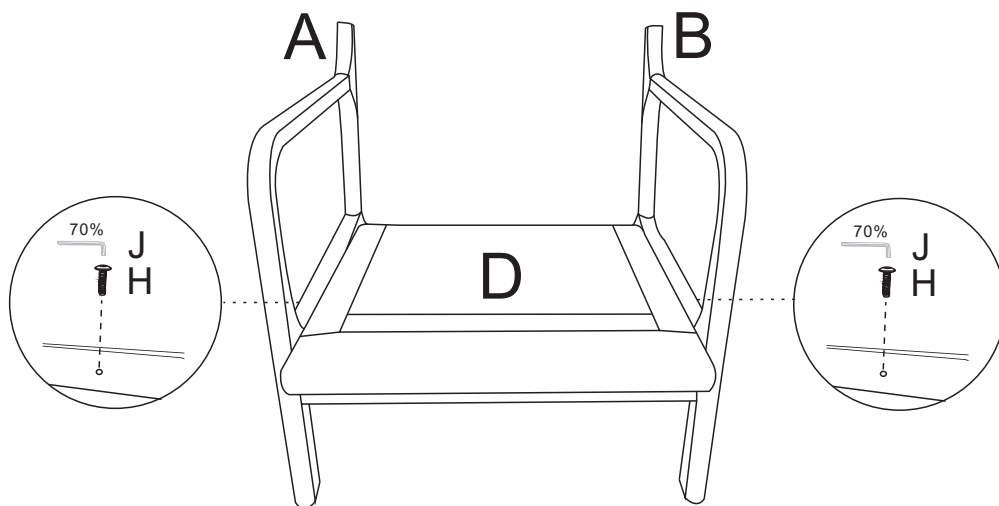

STEP 3

Connect Seat frame D to Arm A/B with screw H
(Next install the screws near the back of the seat)

Note: screw should only be 70% tight

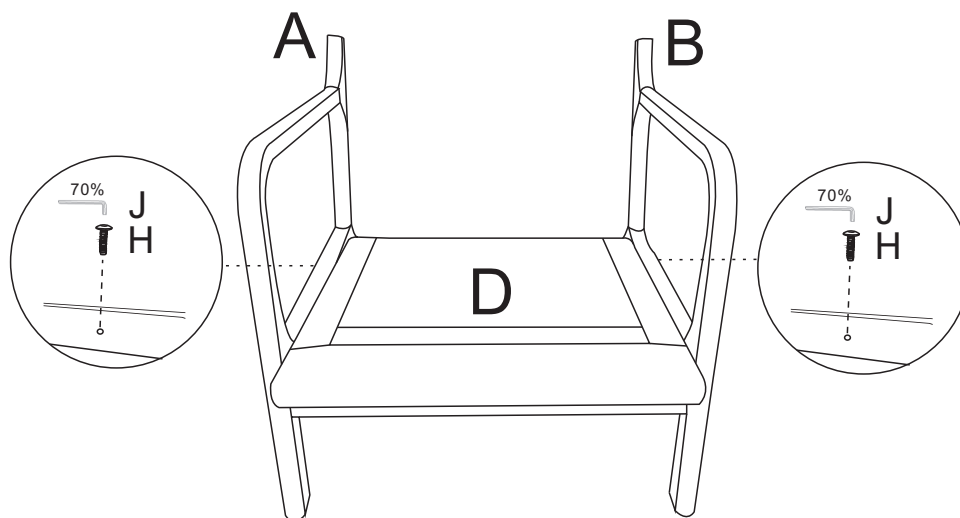

STEP 4

Connect Back frame C to Arm A/B with screw H

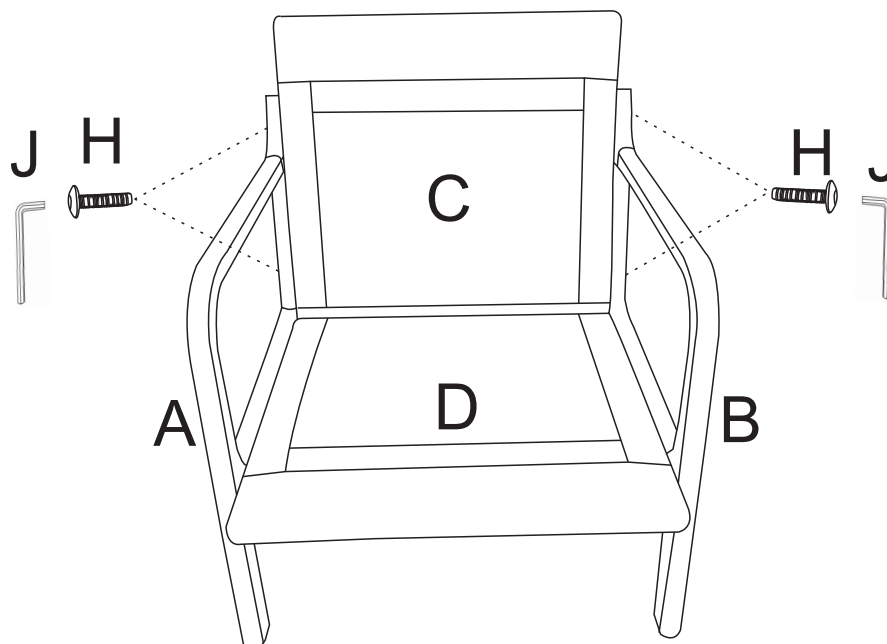

STEP 5

Tighten all screws

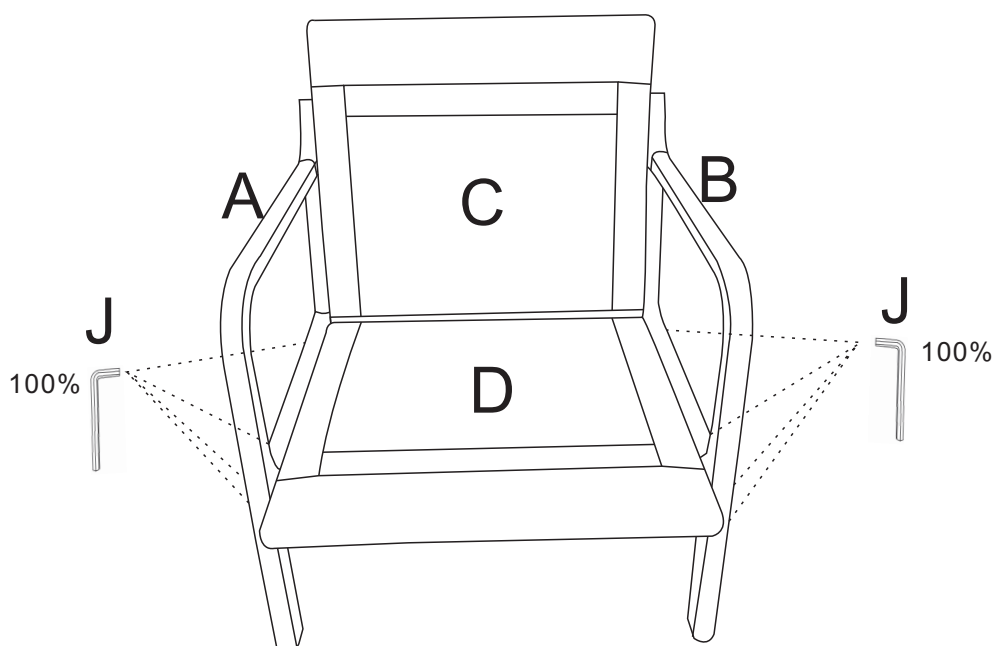

STEP 6

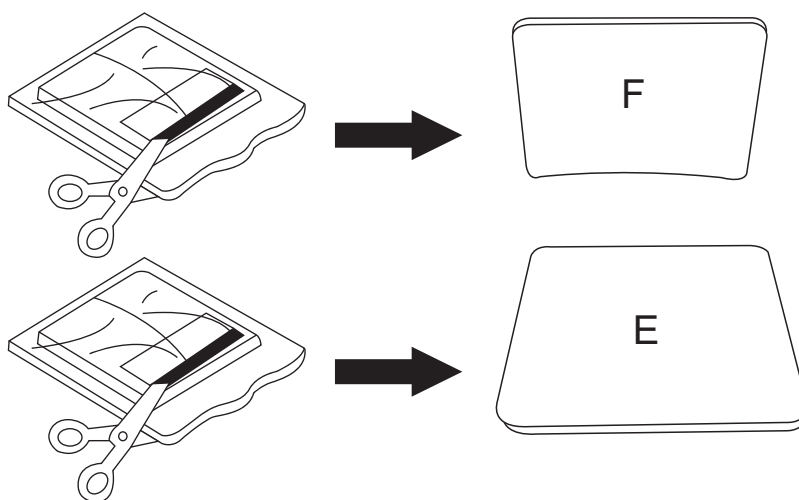

1. Cut open the compression package and remove the seat cushion and back cushion
2. Compression package after cutting, after standing for 24 hours, more comfortable

STEP 7

Load in the cork

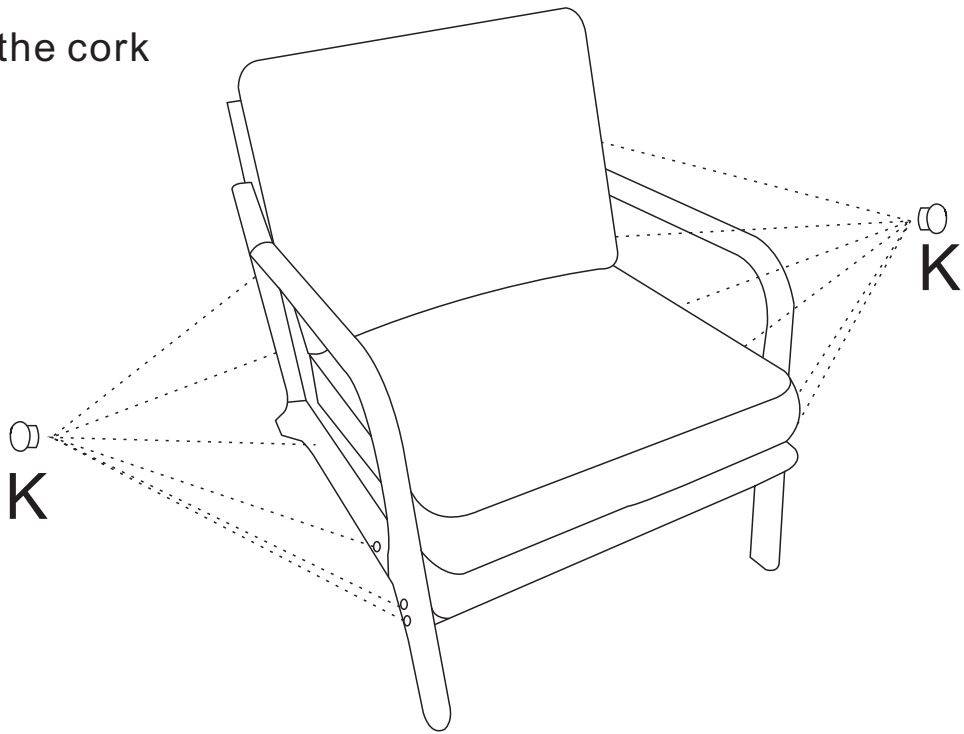

STEP 8

Have cushion E/F/L placed respectively

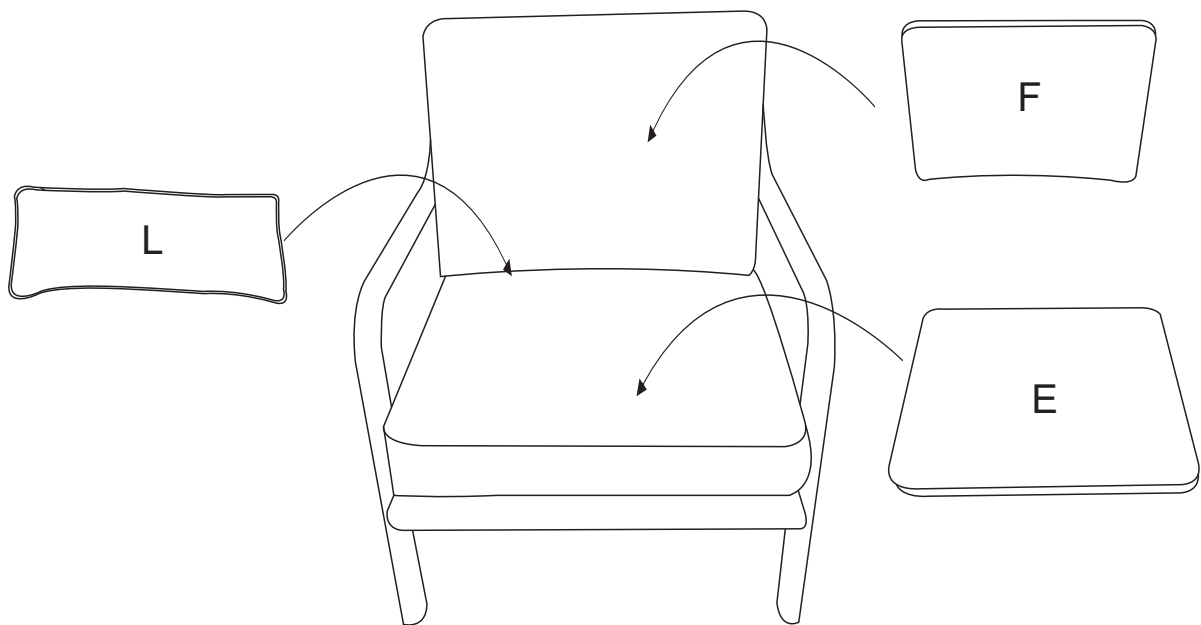

STEP 9

Well done!

