

# Assembly Instruction

**CAUTION:** Read instruction carefully and turn electricity off at main circuit breaker panel before beginning installation.



## Care and Cleaning







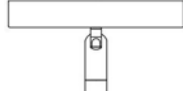

To clean the outside of the fixture, use a dry or slightly dampened clean cloth (use clean water, never a solvent) to wipe the surface of the fixture.

To clear the inside of the fixture, first disconnect power to the fixture by turning off the circuit breaker or by removing the fuse at the fuse box. Next, use a dry or slightly dampened clean cloth (use clean water, never a solvent) to wipe the interior surface of the fixture.

Do not use any cleaners with chemical, solvents or harsh abrasives. Use Only a dry soft cloth to dust or wipe carefully.

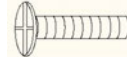
Estimated Assembly Time: 30 minutes

## Part List and Hardware List

PIECE	DESCRIPTION	PICTURE	QUANTITY	PIECE	DESCRIPTION	PICTURE	QUANTITY
A	Lamp Body		1X	F	Canopy		1X
B	Bulb		1X	G	Mounting Plate		1X
C	Long Stem		2X	H	Mounting Screw		2X
D	Short Stem		2X	I	Wire Nut		3X
E	Canopy Nut		2X				

# Installation

## Step 1

Unpack all parts from cartons carefully.  
Fix the Mounting Plate(G) to the junction box with Mounting Screw (H).

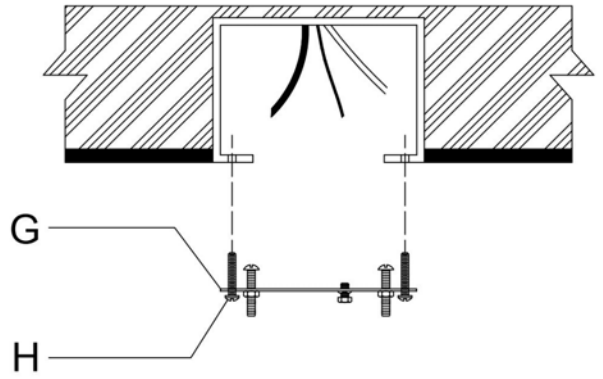

## Step 2

Screw the Long Stem (C) and Short Stem (D) to the Lamp Body (A). Make sure to feed the branchwires of the fixture through the stems during assembly. Remove or add stems to adjust the height. Then screw the canopy (F) to the stem.

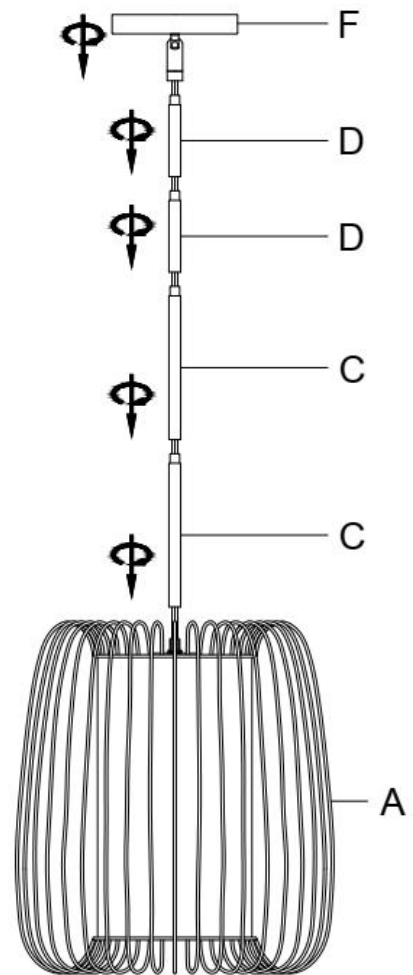

## Step 3 Wire connection

Connect,Hot,Black or Red outlet Supply Wire to:	Connect,Neutral,White Outlet Supply Wire to:
Black	White
*Parallel Cord(round&smooth)	*Parallel Cord(square&ridged)
Clear,Brown,Gold or Black without Tracer(colored stripes)	Clear,Brwn,Gold or Black without Tracer(colored stripes)
Insulated Wire(not green)with copper metal conductor	Insulated Wire(not green)with Silver metal conductor

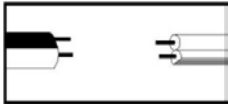

\*Note: When parallel wire(SPTI&SPTII)is used. The neutral wire is square shaped and ridged and the hot wire will be round in shape and smooth.(See illustration on left)

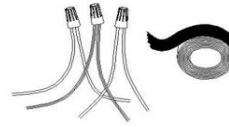

#### Grounding Instructions:

- For installation in the United States: Wrap ground wire from outlet box around green ground screw on mounting bracket, no less than 2" from wire end. Tighten ground screw. If fixture is supplied with a ground wire, connect to outlet ground wire with a wire connector.
- For installation in Canada: If fixture is supplied with ground wire, wrap ground wire around green grounding screw on mounting bracket. Tighten ground screw.

## Step 4

Attach the Canopy(F) to the Mounting Plate (G) , and fix it by turning the Canopy Nut (E) clockwise. Insert the bulbs (B) into the Sockets.

**PLEASE USE TYPE"A" BULB MAX 40-WATT OR CFL BULB MAX 13-WATT OR LED BULB MAX 9-WATT  
THERE IS 1PC LED 4-WATT BULB IN THE BOX**

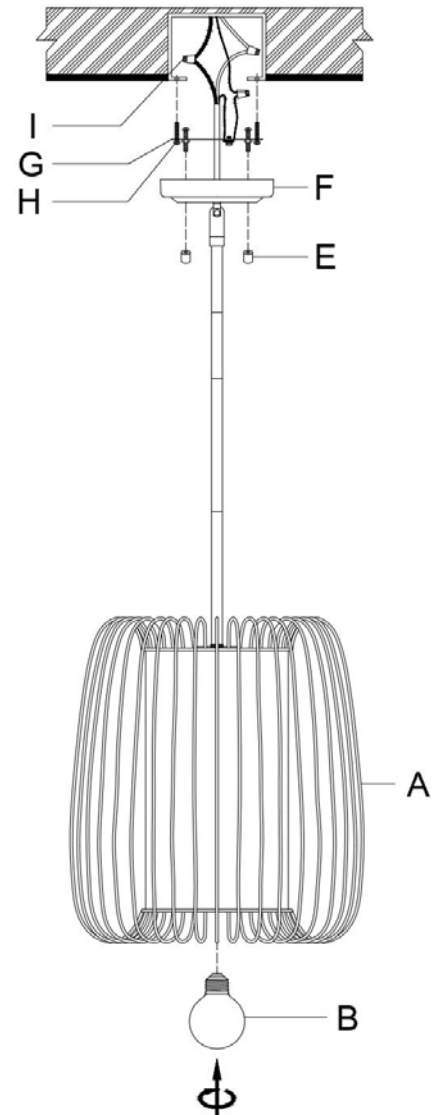

## Step 5

Consult a qualified electrician to ensure correct branch circuit conductor.

ENJOY YOUR LAMP