

Hall Tree

Assembly Instructions - Please keep for future reference

! WARNING



This product is NOT a Clothing Storage Unit (CSU).
DO NOT use it for clothing storage.
Improper use may cause furniture tipover.

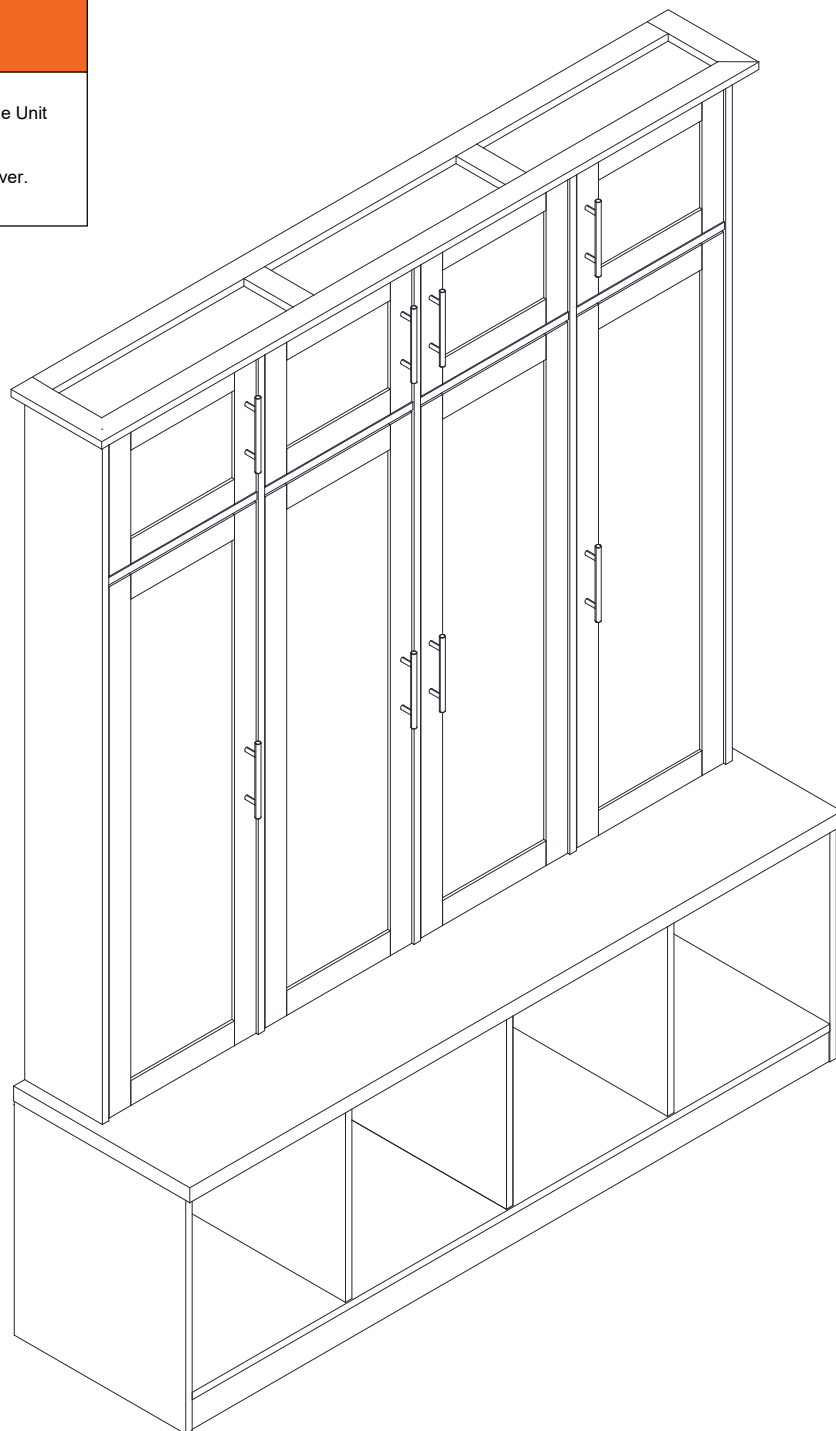

Dimensions

Width- 59.50inch

Depth- 16.00inch

Height- 75.00inch

Important – Please read these instructions fully before starting assembly



Safety and Care Advice

Important – Please read these instructions fully before starting assembly

- Check you have all the components and tools listed on the following pages.
- Remove all fittings from the plastic bags and separate them into their groups.
- Keep children and animals away from the work area, small parts could choke if swallowed.
- Make sure you have enough space to layout the parts before starting.

- During assembly do not stand or put weight on the product, this could cause damage.
- Assemble the item as close to its final position (in the same room) as possible.
- Assemble on a soft level surface to avoid damaging the unit or your floor.
- Parts of the assembly will be easier with 2 people.



power drill is set on a low torque setting.

- To reduce the likelihood of damaging your product please ensure that your

Care and maintenance

• Only clean using a damp cloth and mild detergent, do not use bleach or abrasive cleaners.

• From time to time check that there are no loose screws on this unit.

• This product should not be discarded with household waste. Take to your local authority waste disposal centre.

Handy Hints

• Assemble all parts and bolts loosely during assembly, only once the product is complete should you fully tighten the bolts

• Regularly check and ensure That all bolts and fittings are tightened properly.

WARNING
In order to help prevent overturning – please follow these instructions









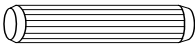

To help prevent product toppling over please follow the below steps:-

- Use the anti tip stap or wall fixing method provided (if applicable)
- Do not allow children to climb or hang on the furniture
- Do not open more than one drawer at a time
- Do not place heavy items in the top drawers
- Do not place heavy items on top of the furniture, unless the furniture has been designed for this purpose

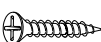
Components - Fittings

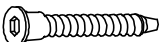
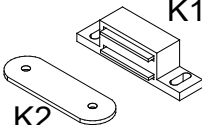
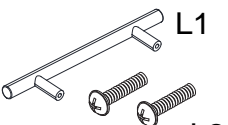
Please check you have all the panels listed below

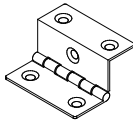
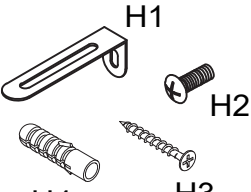
Note: The quantities below are the correct amount to complete the assembly. In some cases more fittings may be supplied than are required

<p>A</p>  <p>15*12mm Cam lock x70+2</p>	<p>C</p>  <p>15*9.5mm Cam lock x70+2</p>	<p>D</p>  <p>6x60mm Dowel x 16</p>	<p>E</p>  <p>6x40mm Dowel x 58</p>
<p>F</p>  <p>3x12mm Screw x 122</p>	<p>G</p>  <p>3x16mm Screw x 46</p>	<p>I</p>  <p>Black panel Buckle x22</p>	<p>J</p>  <p>7x40mm Screw x 7</p>
<p>K</p>  <p>K1 K2 x8</p>	<p>L</p>  <p>L1 L2 x8</p>	<p>M</p>  <p>x4</p>	<p>P</p>  <p>Triple fold hinge x20</p>
<p>H</p>  <p>H1 H2 H3 H4 x3</p>	<p>O</p>  <p>x72</p>		

Tools required Not Included

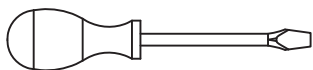

Phillips screwdriver
(medium & large)

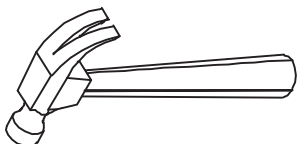
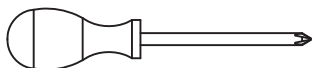

Using Camlocks

Step 1

Connect the male camlock as directed in the assembly instructions using a screwdriver.

1

DO NOT OVER TIGHTEN.
NE PAS SERRER EXCESSIVEMENT.

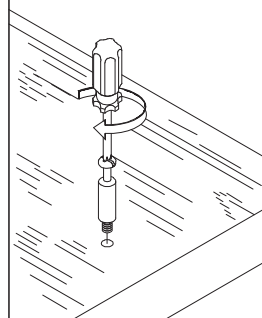

Step 2

Push the male camlock into the entry hole.

2

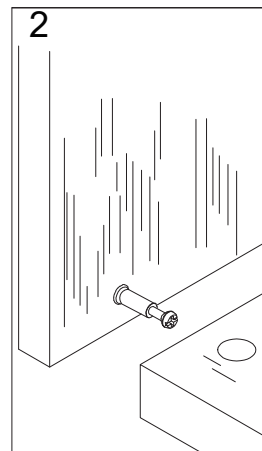

Step 3

Insert the female camlock as shown in the instruction.

Note: ensure that the arrow on the top of the camlock points towards the entry hole for the male camlock.

3

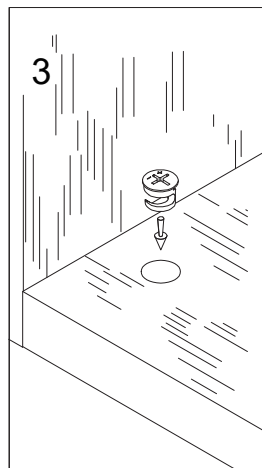

Step 4

Turn the female camlock clockwise with a screwdriver.

You should feel a click when the camlock is locked in place.

The joint is now secure.

4

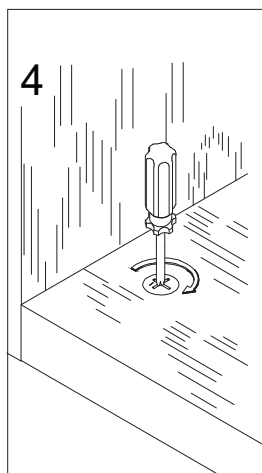

Assembly Instructions

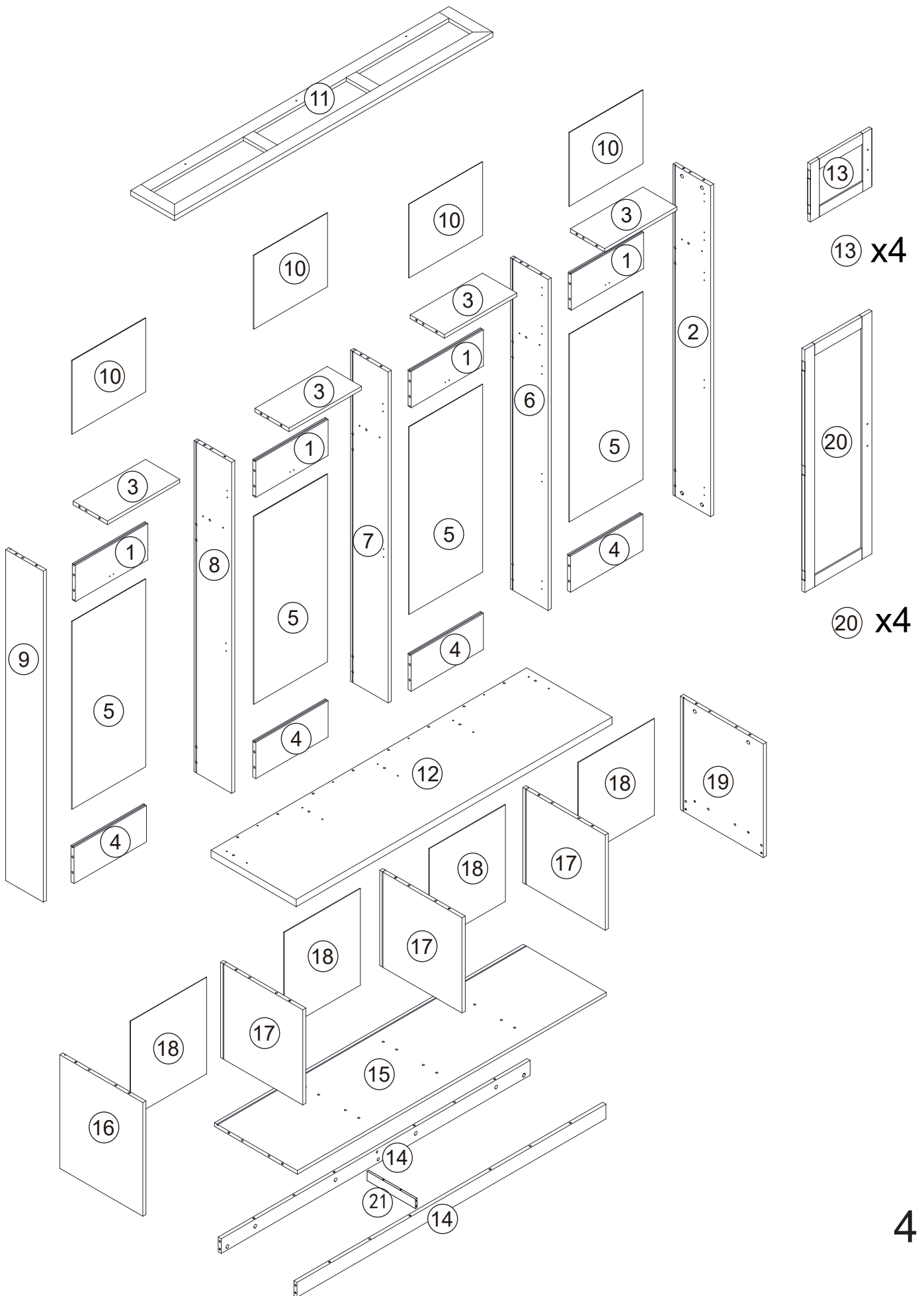

PART LIST

BOX A

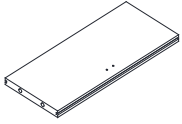

①

x4

upper brace
346x150x12mm

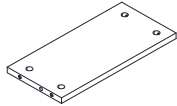

③

x4

upper shelf
346x164x15mm

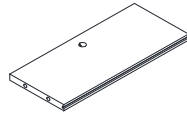

④

x4

lower brace
346x150x12mm

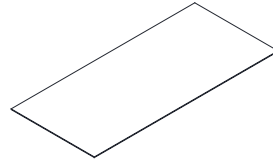

⑤

x4

middle back panel
787x352x4mm

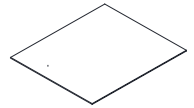

⑩

x4

upper back panel
297x353x3mm

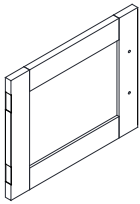

⑬

x4

small door panel
270x341x15mm



⑳

x4

long door panel
1075x341x15mm

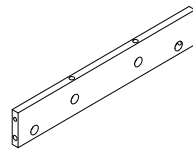

㉑

x1



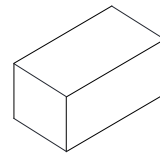

toe tick
356x60x12mm



Hardware kid x1

PART LIST

BOX B

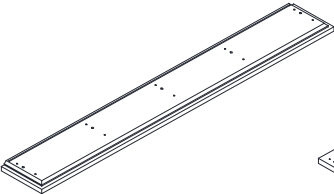
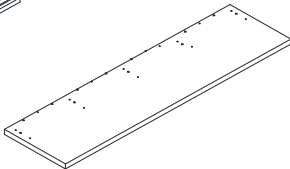
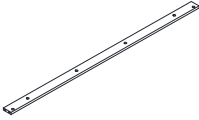
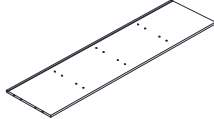
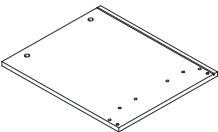
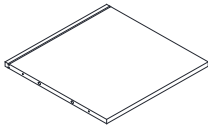
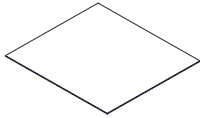
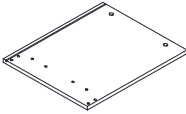
				
② x1	⑥ x1	⑦ x1	⑧ x1	⑨ x1
upper right side panel 1370x180x15mm	middle back panel 1370x180x15mm	middle partition 1370x180x15mm	middle partition 1370x180x15mm	upper left side panel 1370x180x15mm
				
⑪ x1	⑫ x1	⑭ x2	⑮ x1	
top panel 1492x198x15mm	seat panel 1510x400x15mm	toe tick 1465x60x12mm	bottom 1465x398x12mm	
				
⑯ x1	⑰ x3	⑱ x4	⑲ x1	
lower left side panel 470x398x15mm	lower partition 398x398x15mm	lower back panel 404x362x4mm	lower right side panel 470x398x15mm	

Assembly Instructions

Step 1

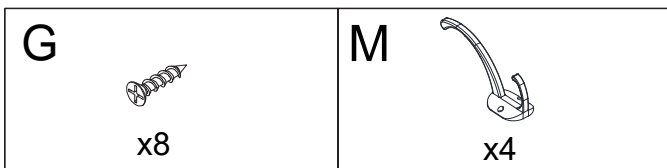
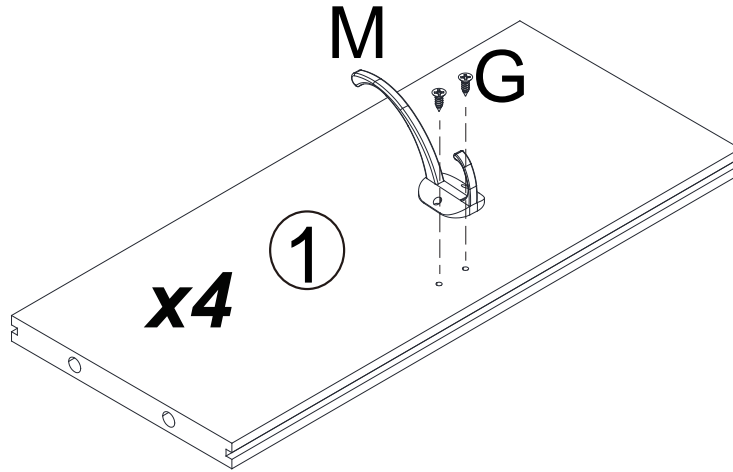

Step 2

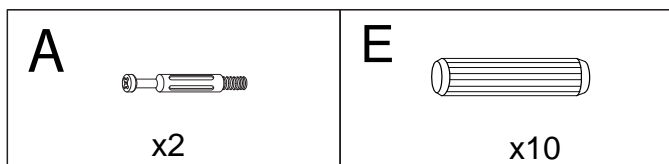
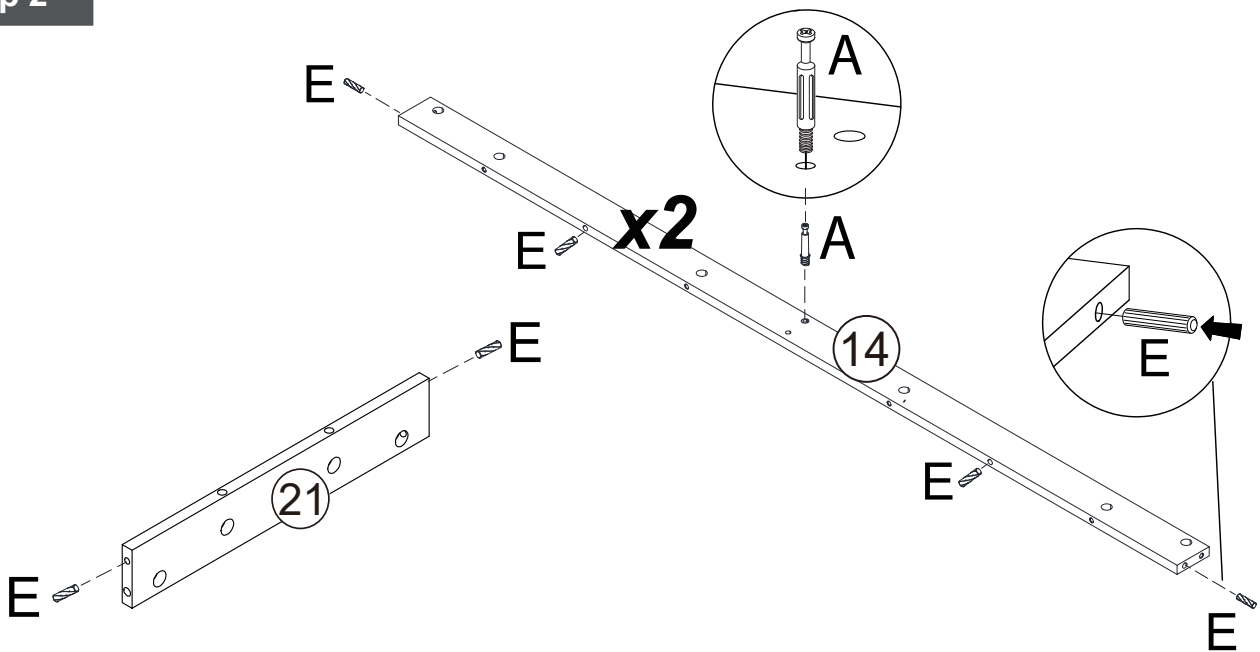

Assembly Instructions

Step 3

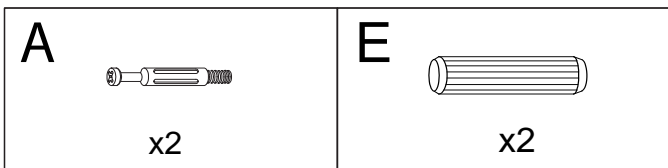
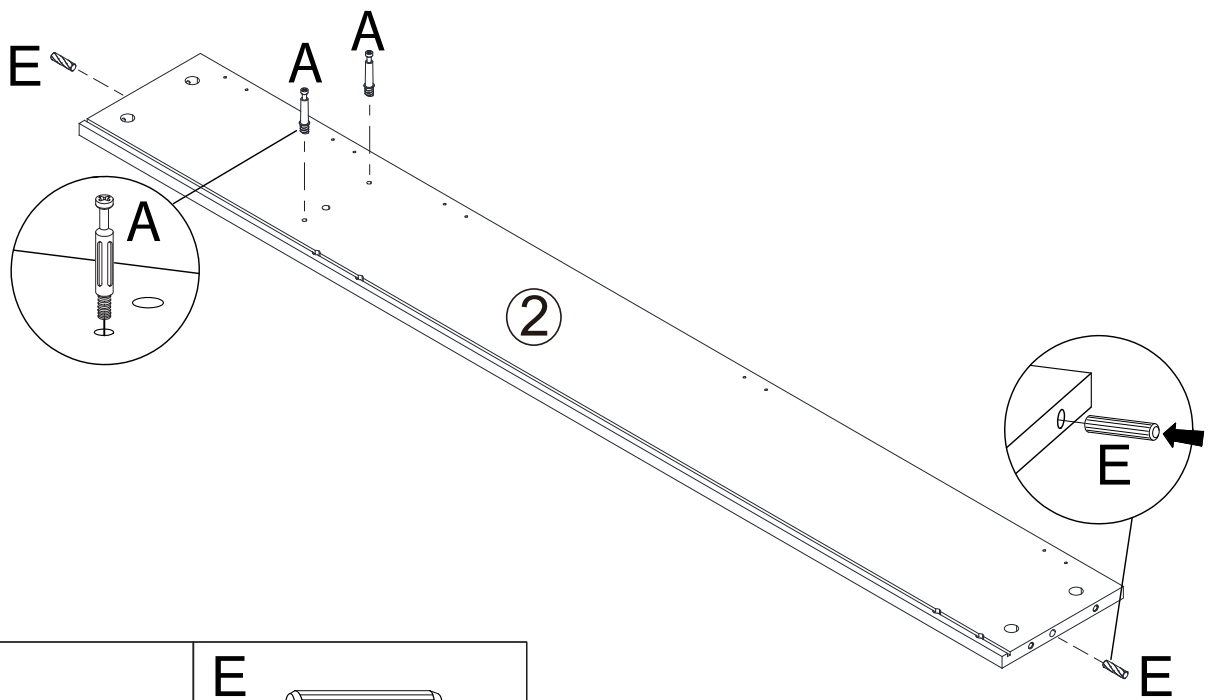

Step 4

Part 6 requires mounting screws on both sides

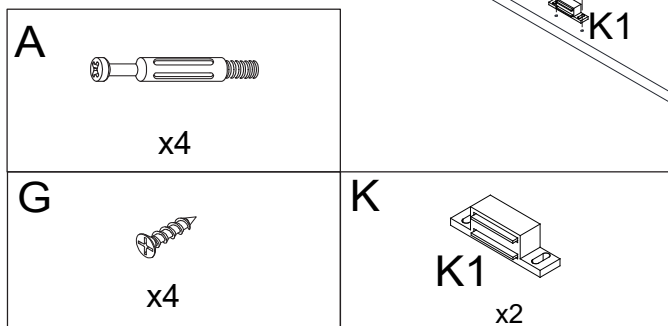
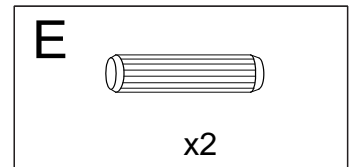
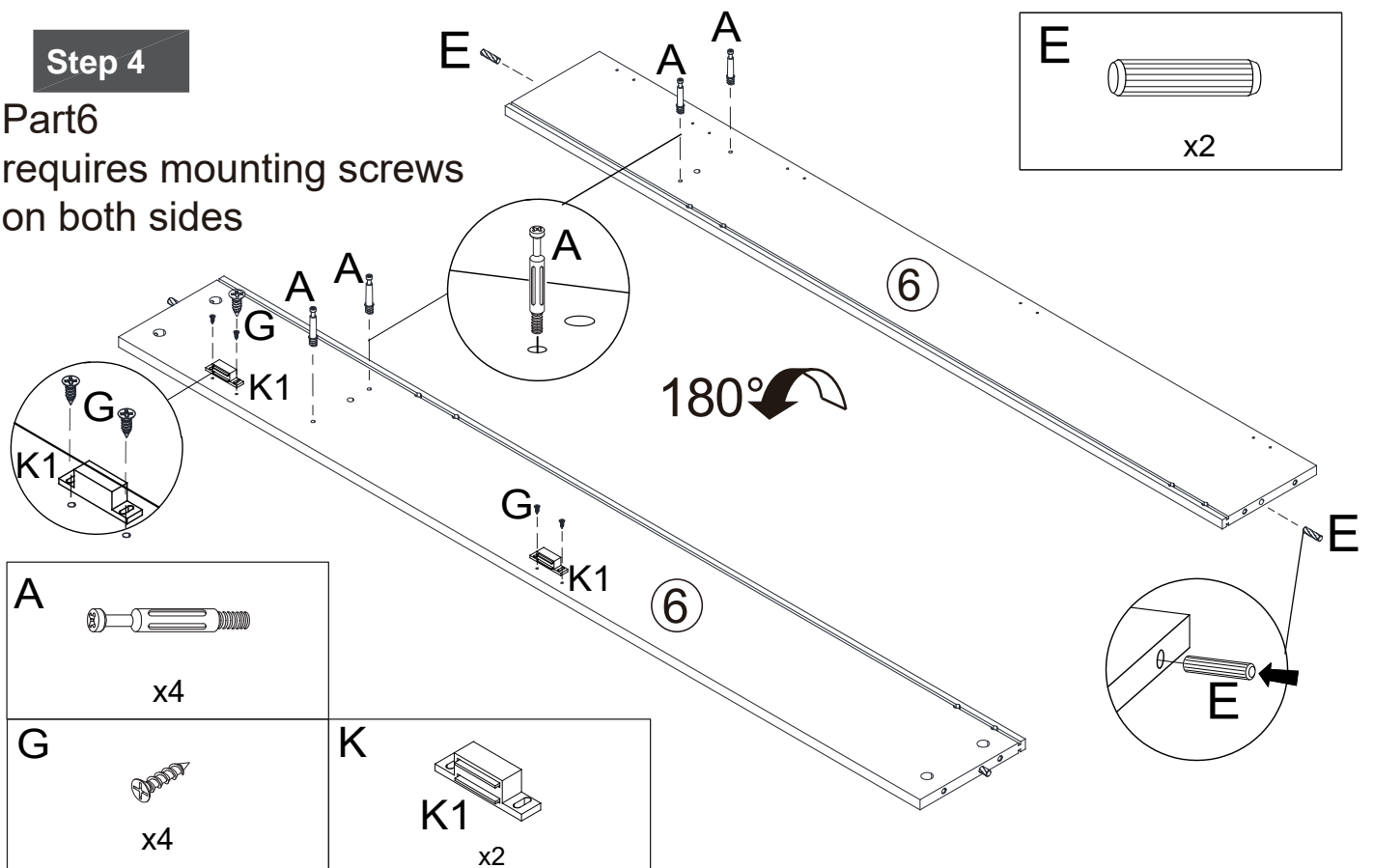

Assembly Instructions

Step 5

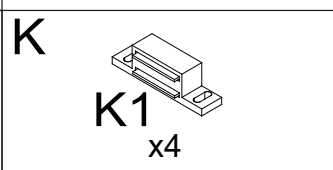
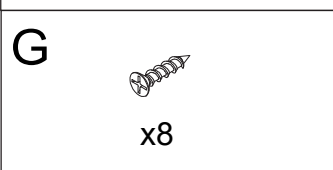
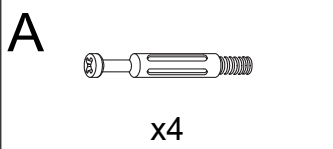
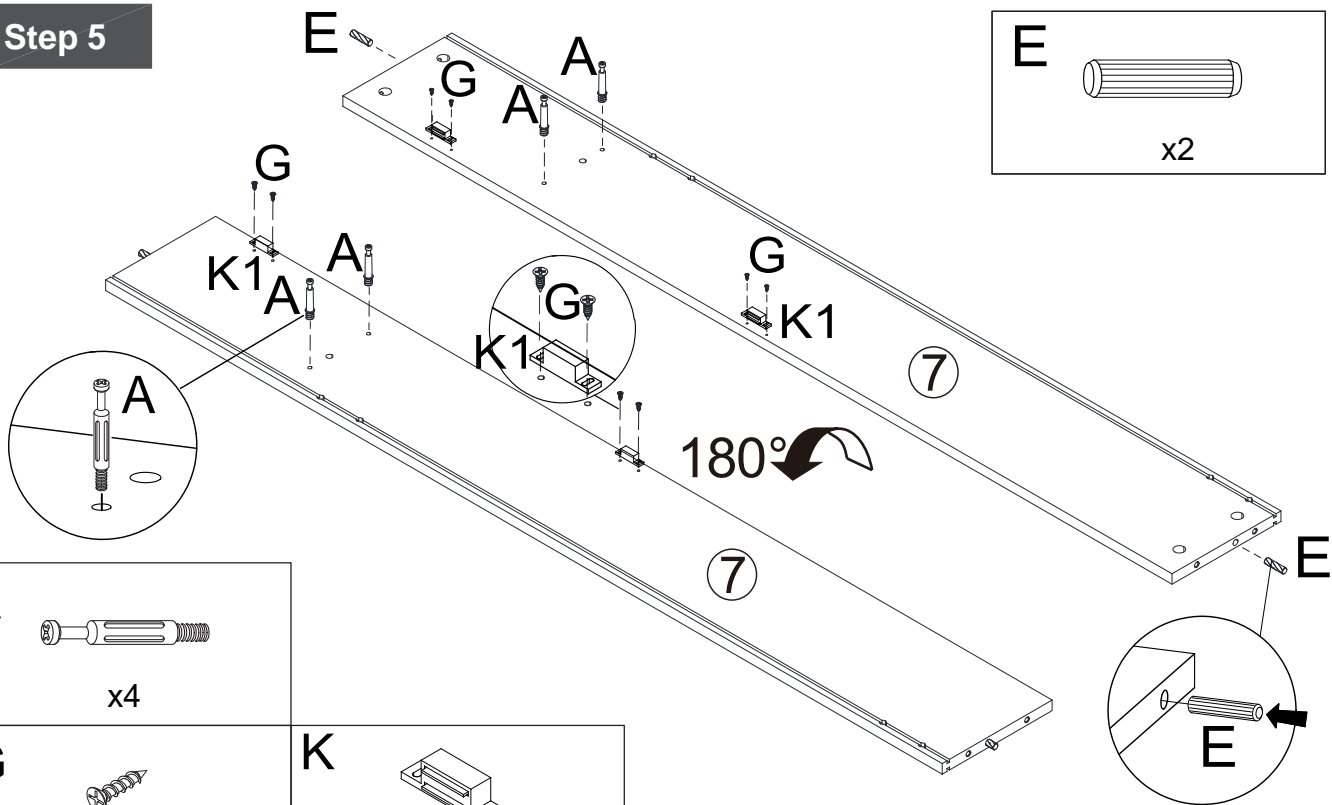

Step 6

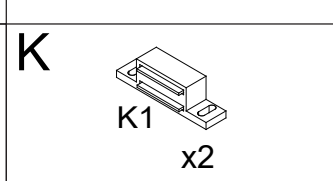
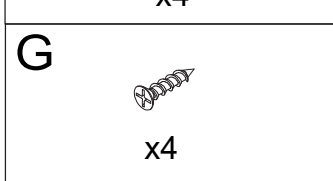
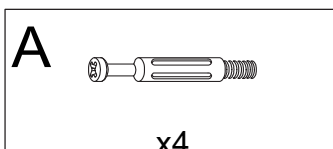
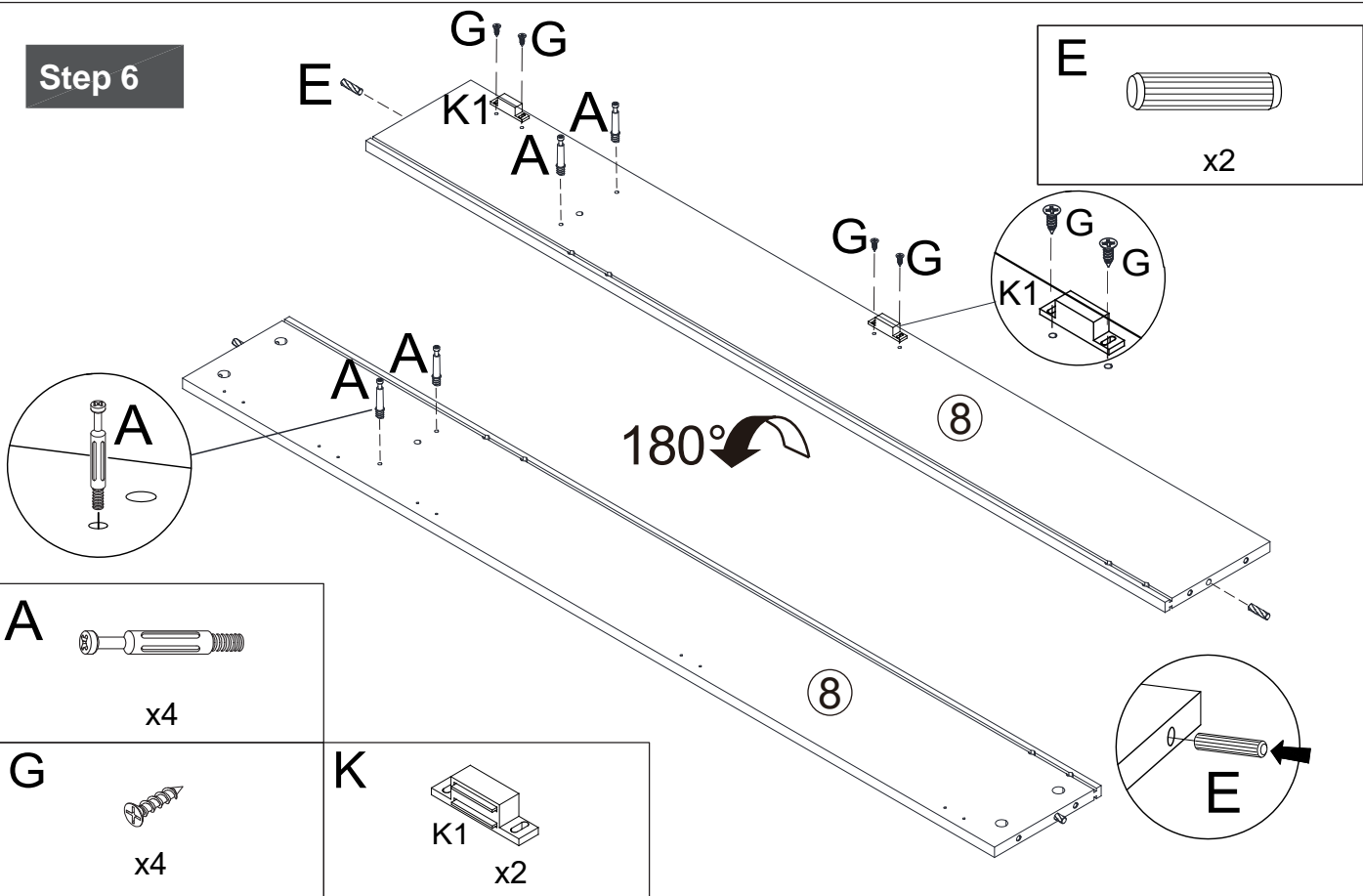

Assembly Instructions

Step 7

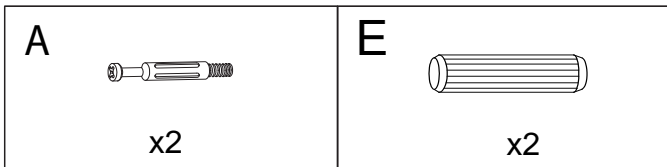
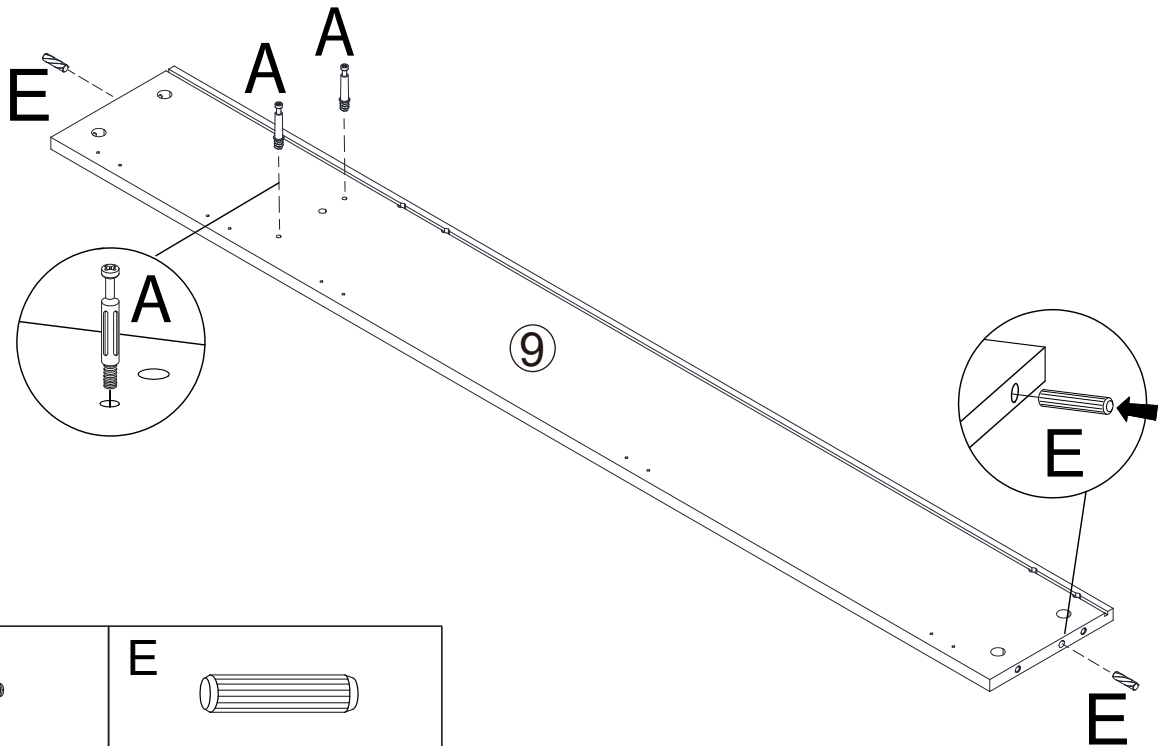

Step 8

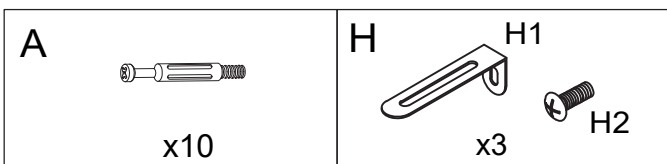
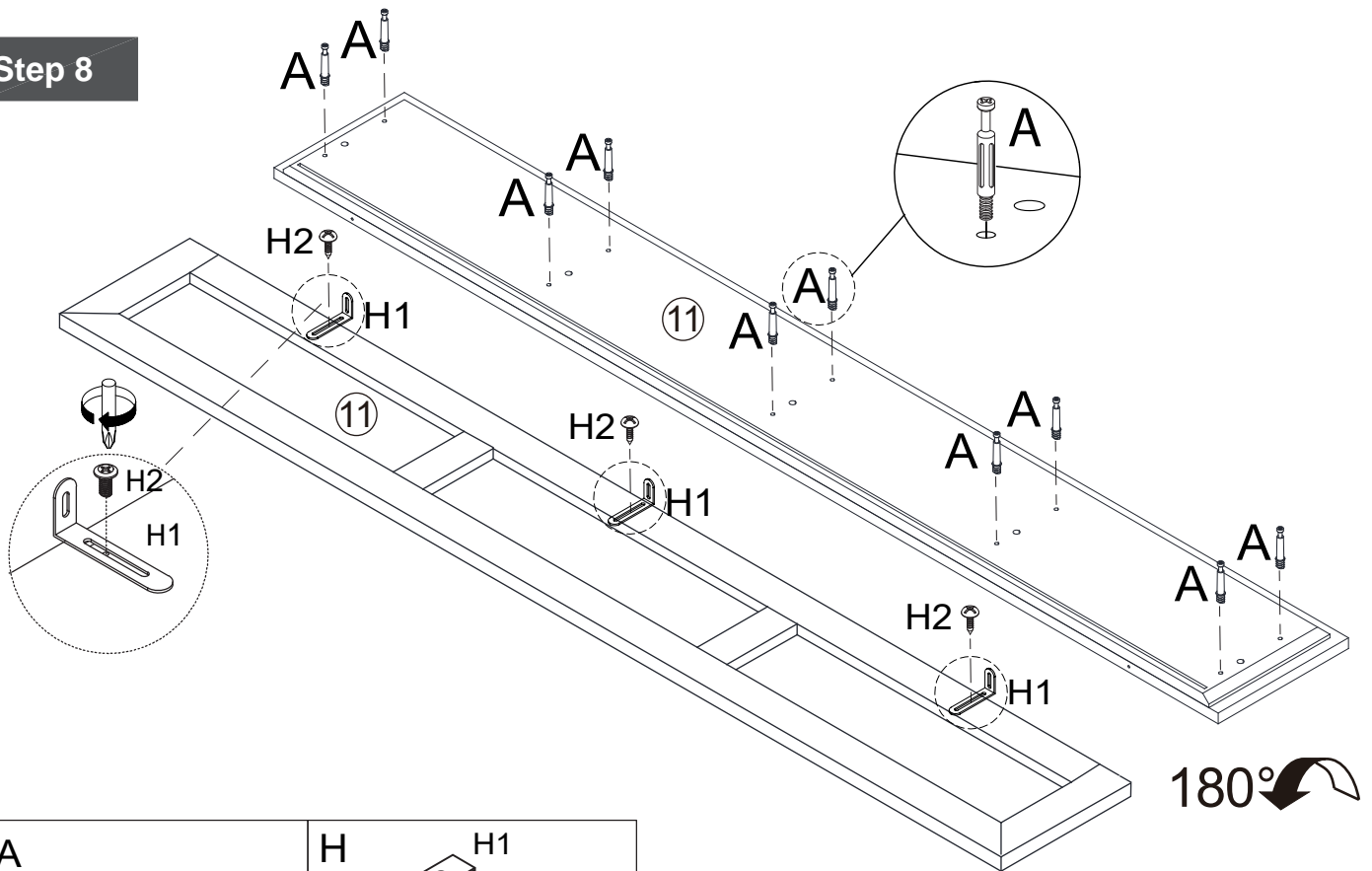

Assembly Instructions

Step 9

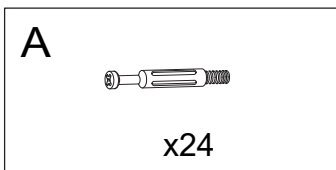
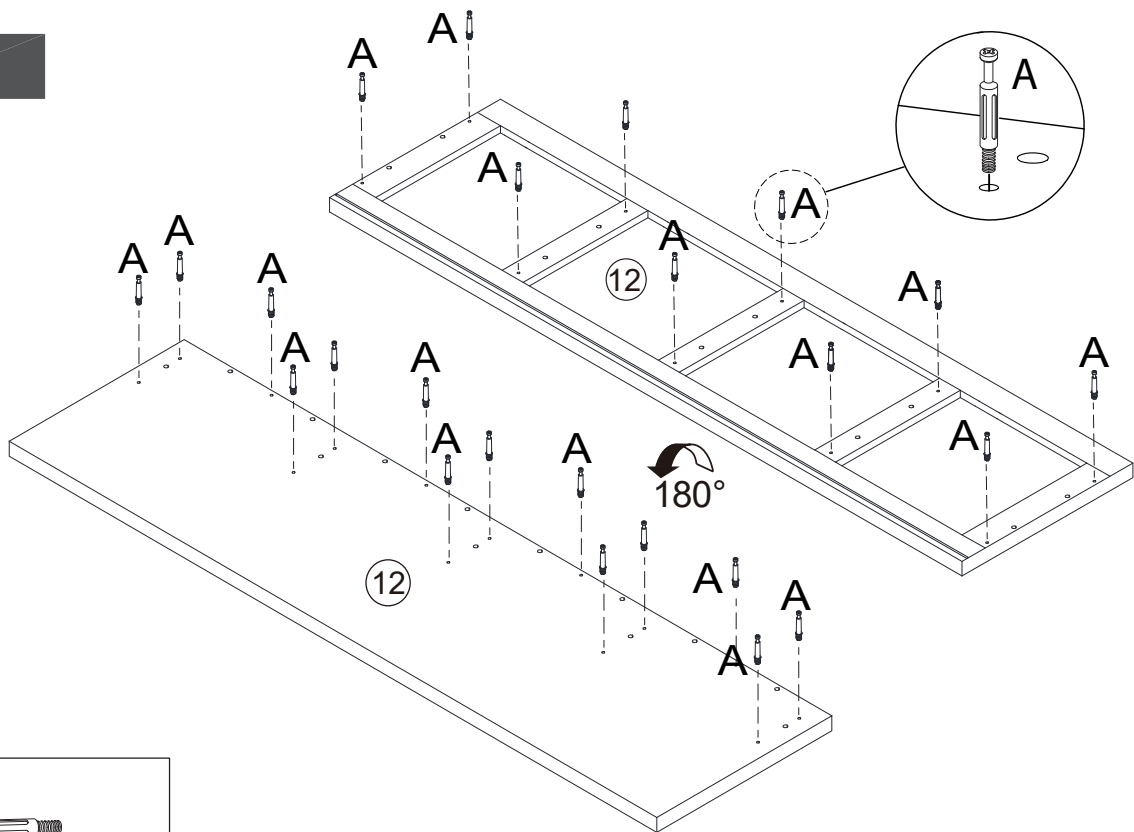

Step 10

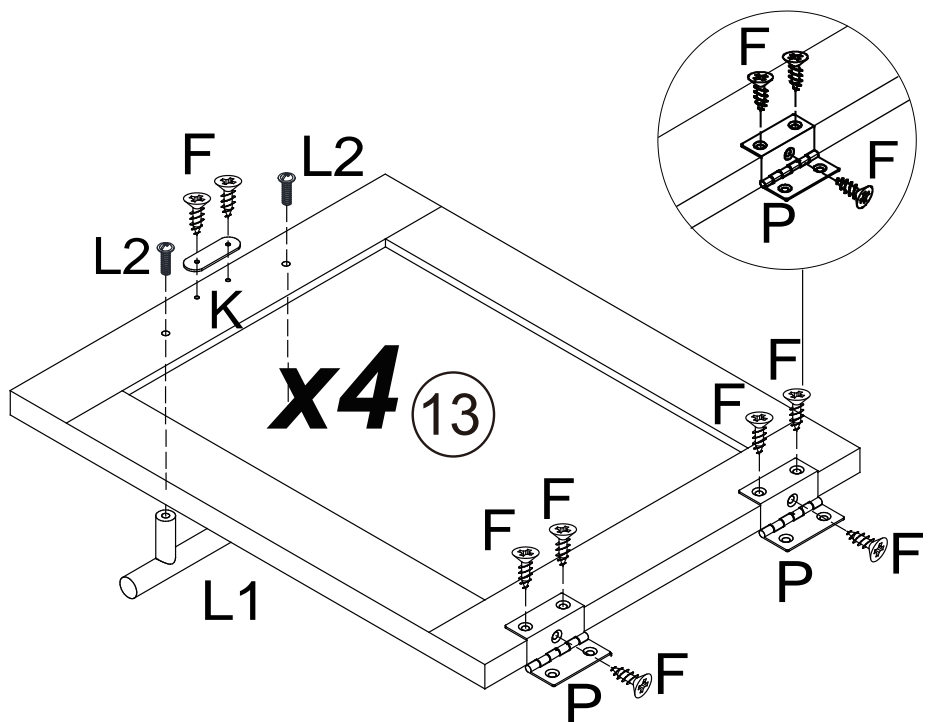
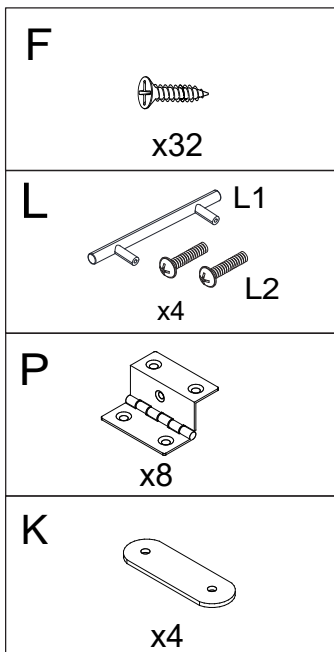

Assembly Instructions

Step 11

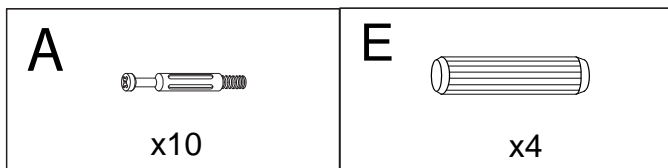
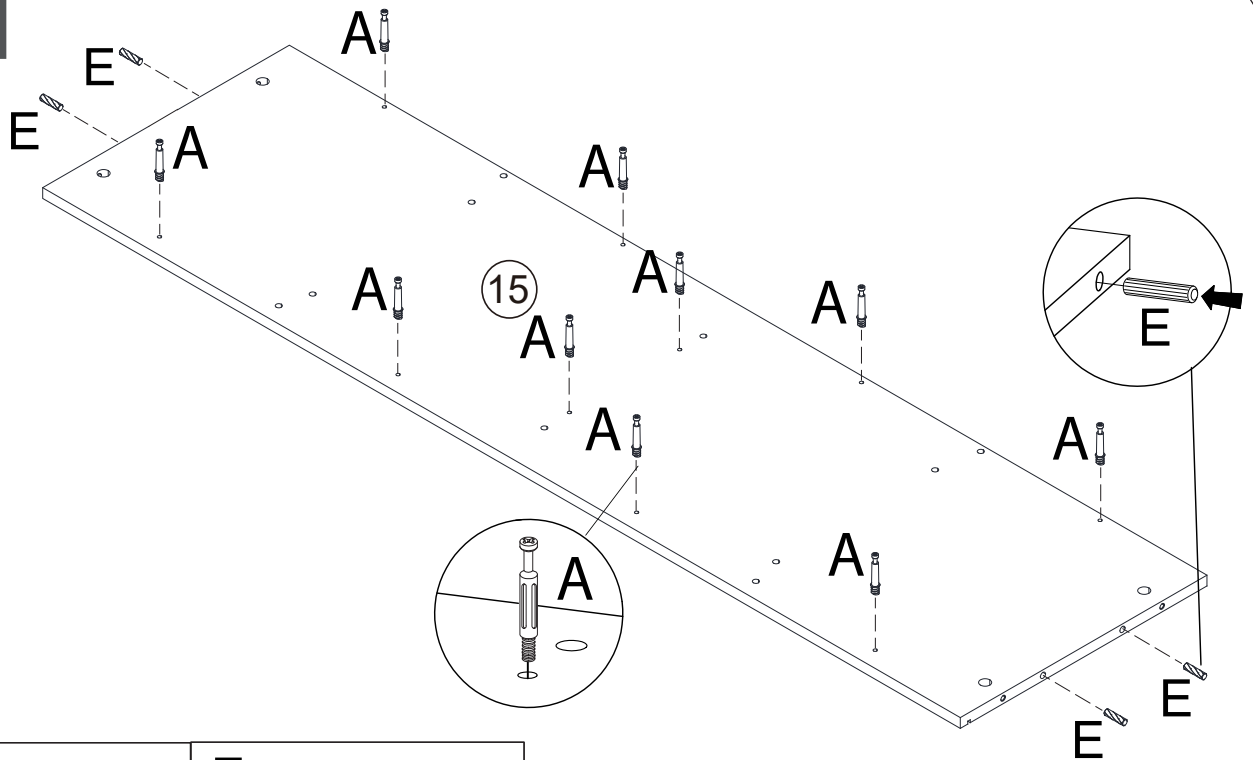

Step 12

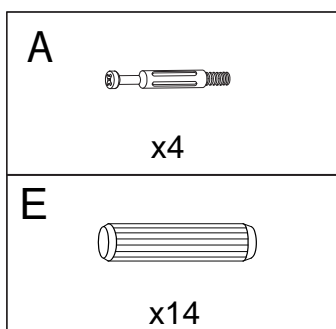
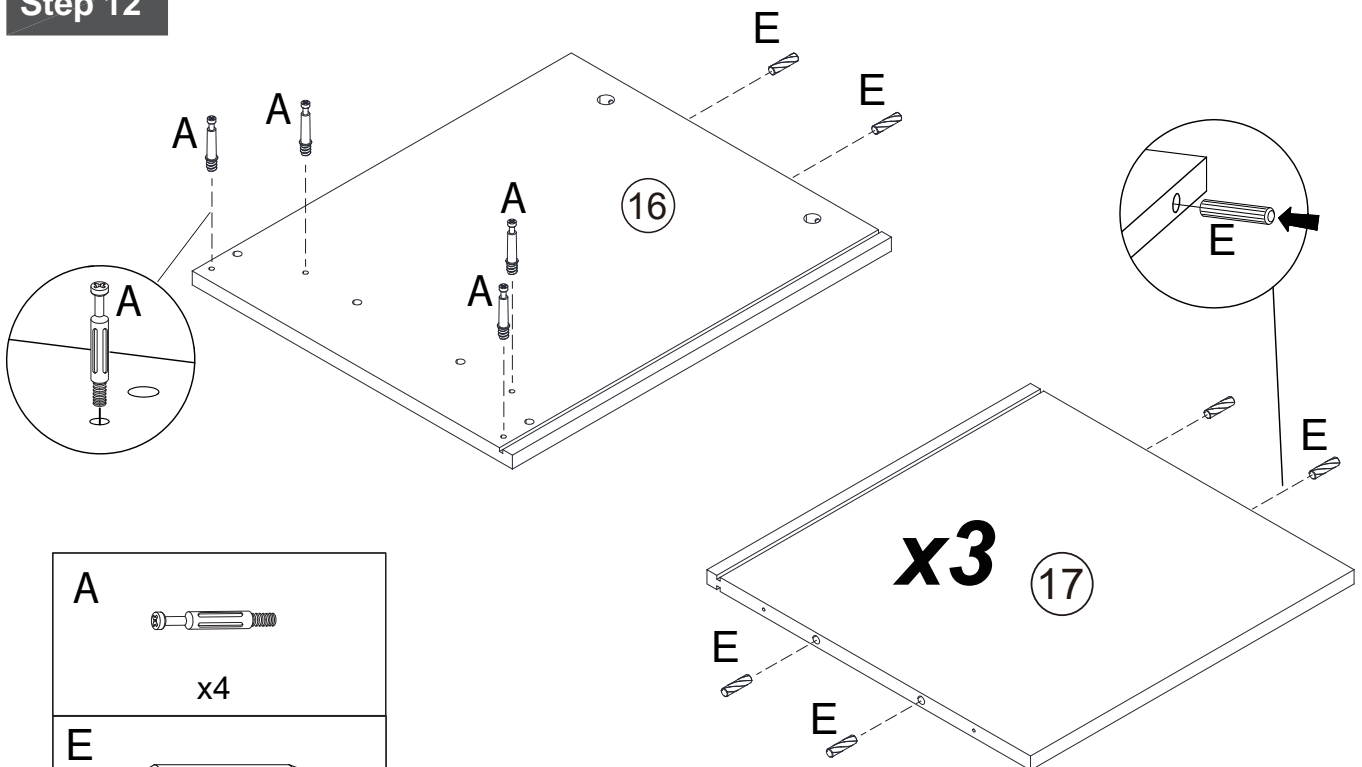

Assembly Instructions

Step 13

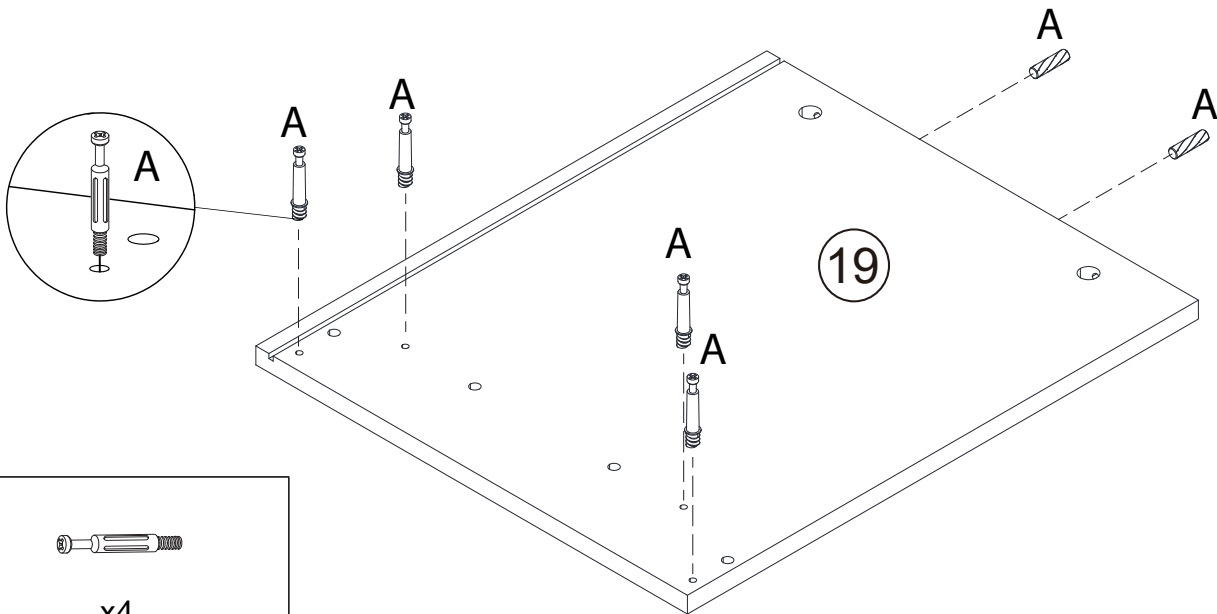

A

x4

E

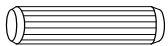

x2

Step 14

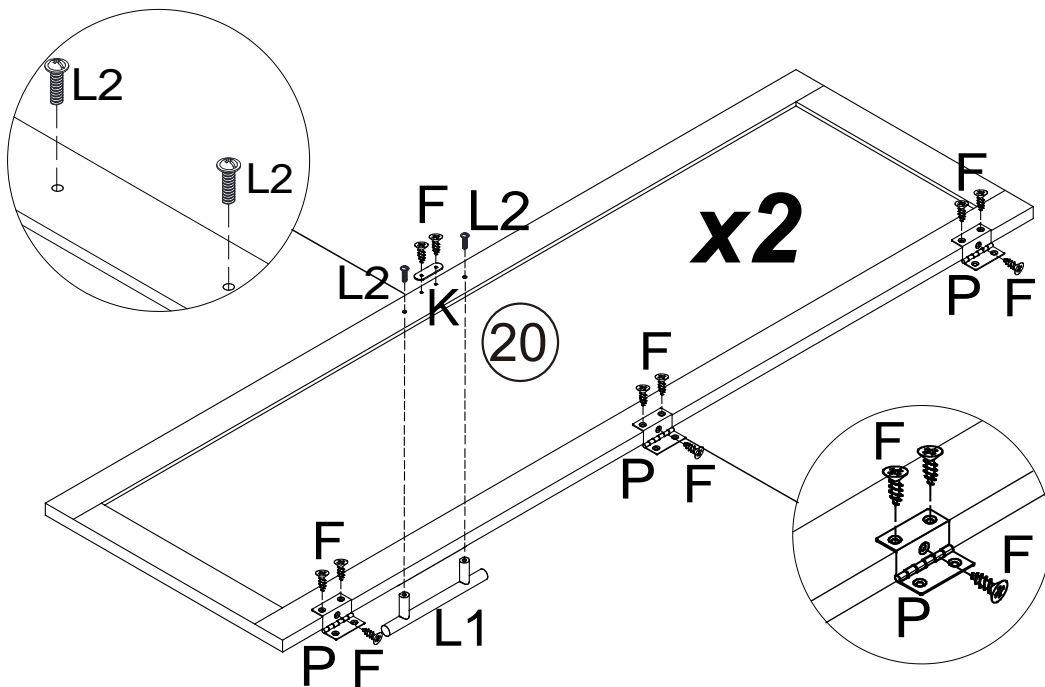

L

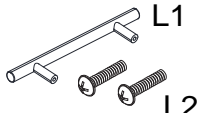

x4

K

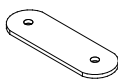

x4

F



x44

P

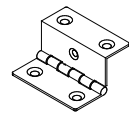

x12

Assembly Instructions

Step 15

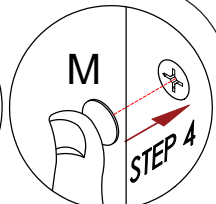
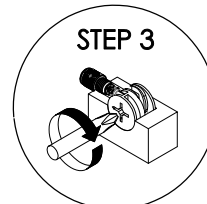
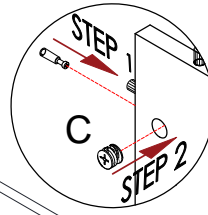
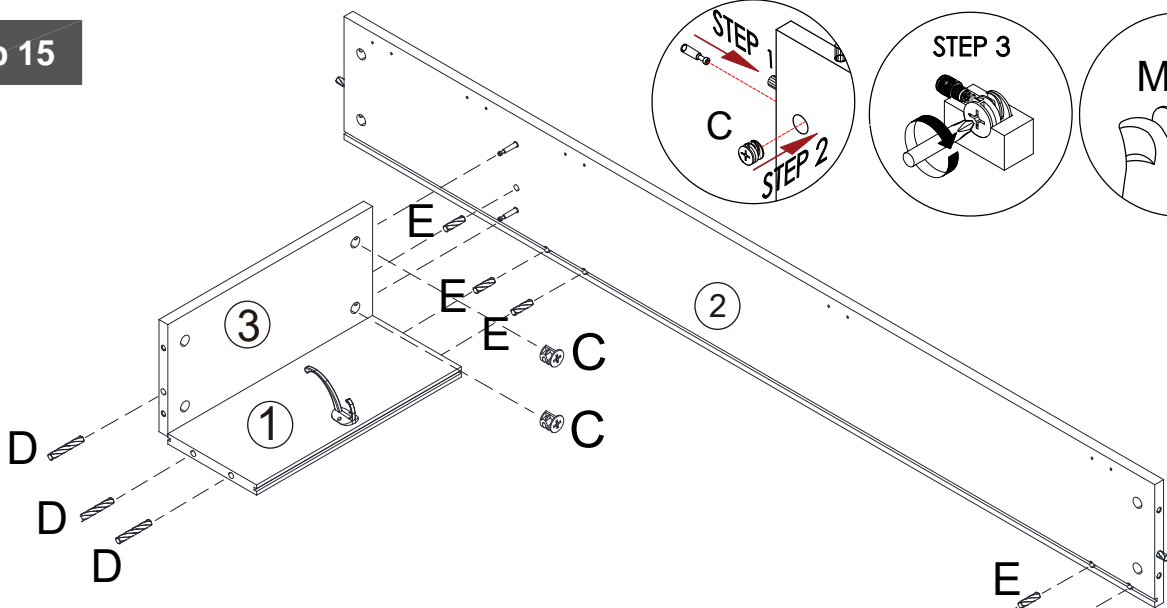

E x7	D x5
C x2	M x2

Step 16

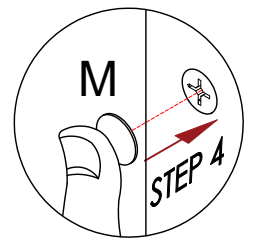
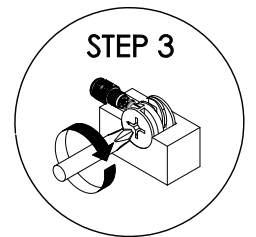
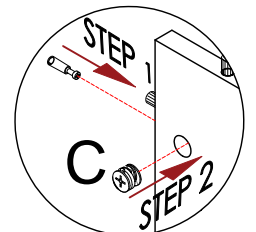
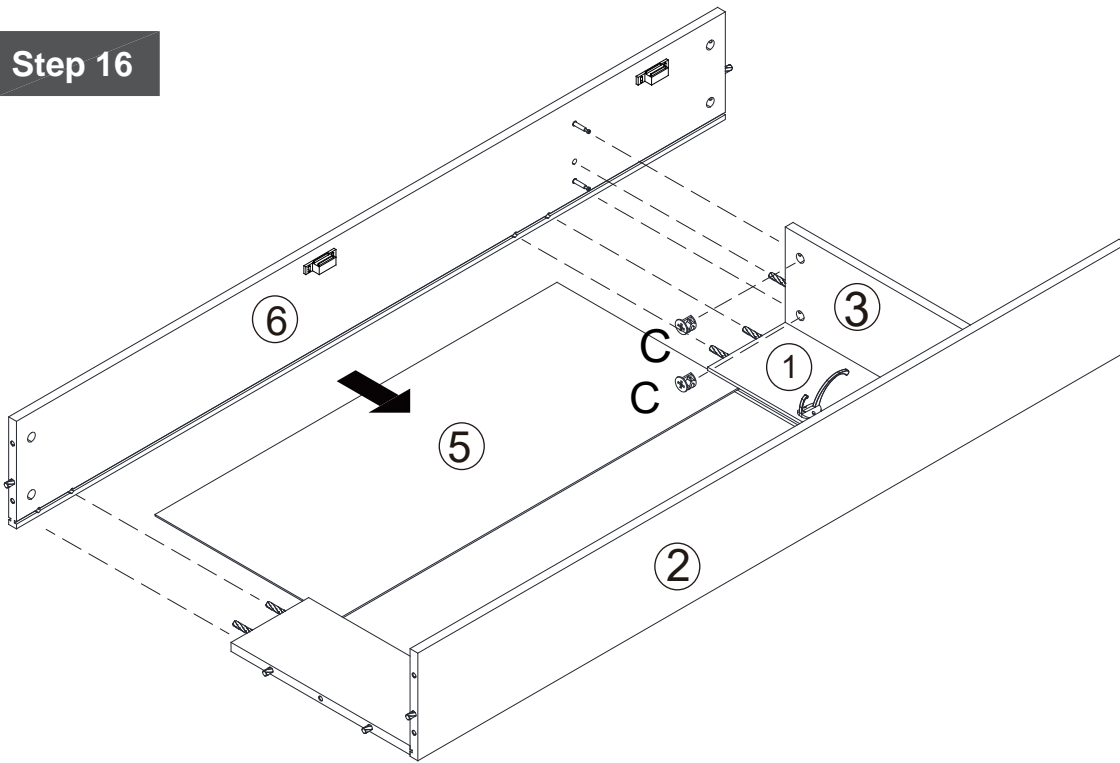



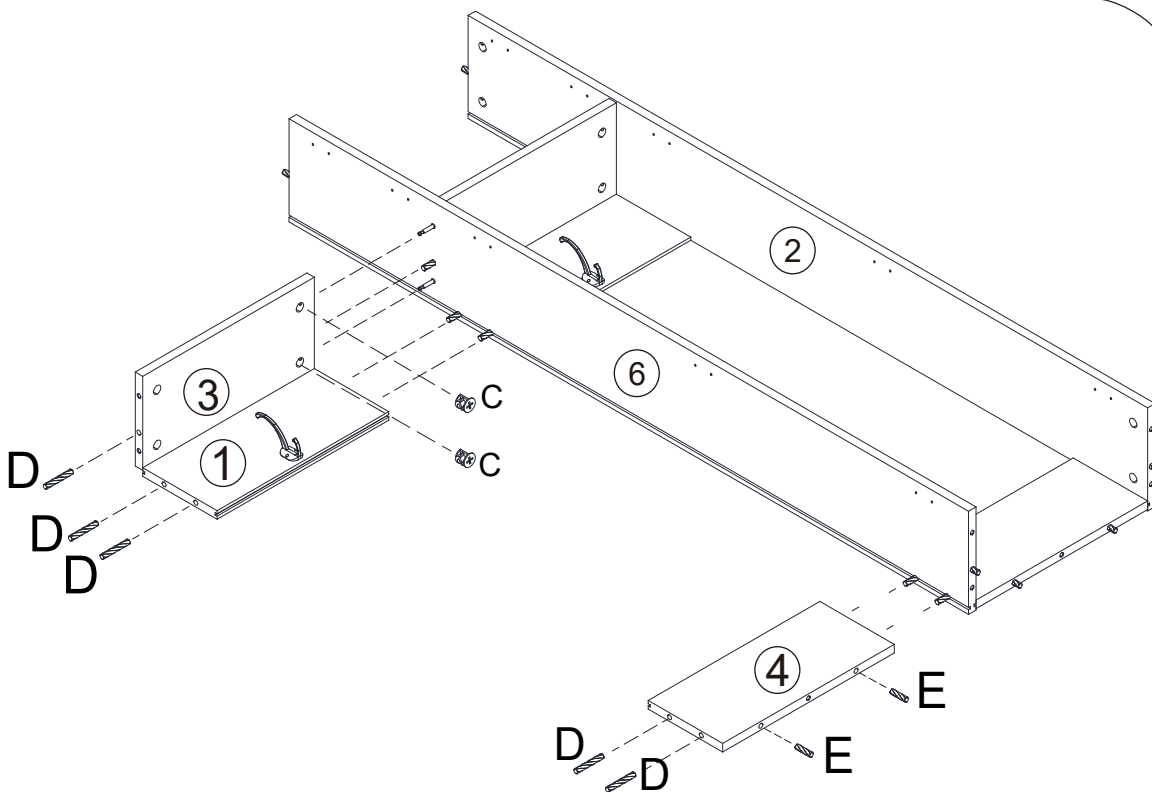
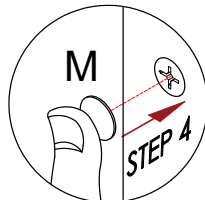
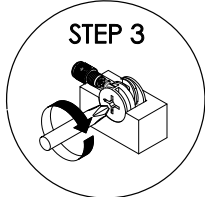
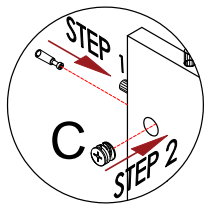

C x2	M x2
---------	---------

Assembly Instructions



Step 17

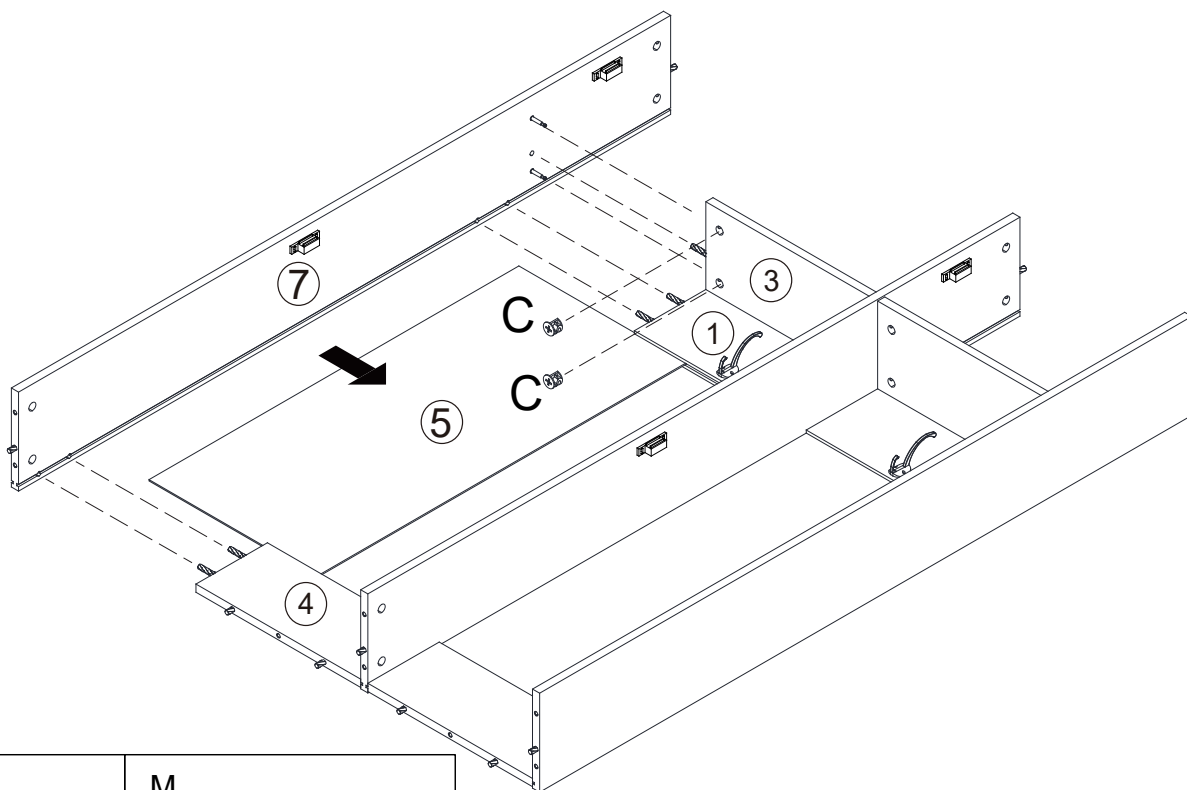
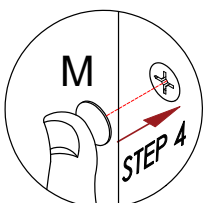
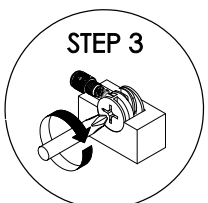
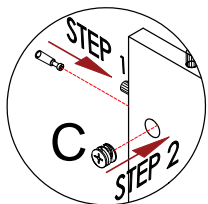

<p>C</p>  <p>x2</p>	<p>M</p>  <p>x2</p>	<p>E</p>  <p>x2</p>	<p>D</p>  <p>x5</p>
--	--	--	--

Step 18



<p>C</p>  <p>x2</p>	<p>M</p>  <p>x2</p>
--	--

Assembly Instructions

Step 19

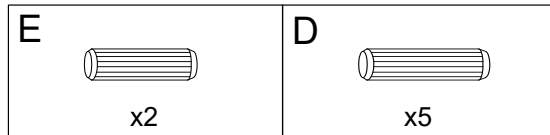
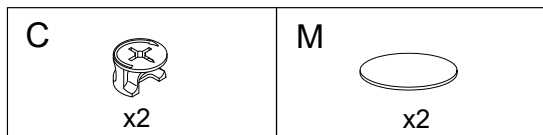
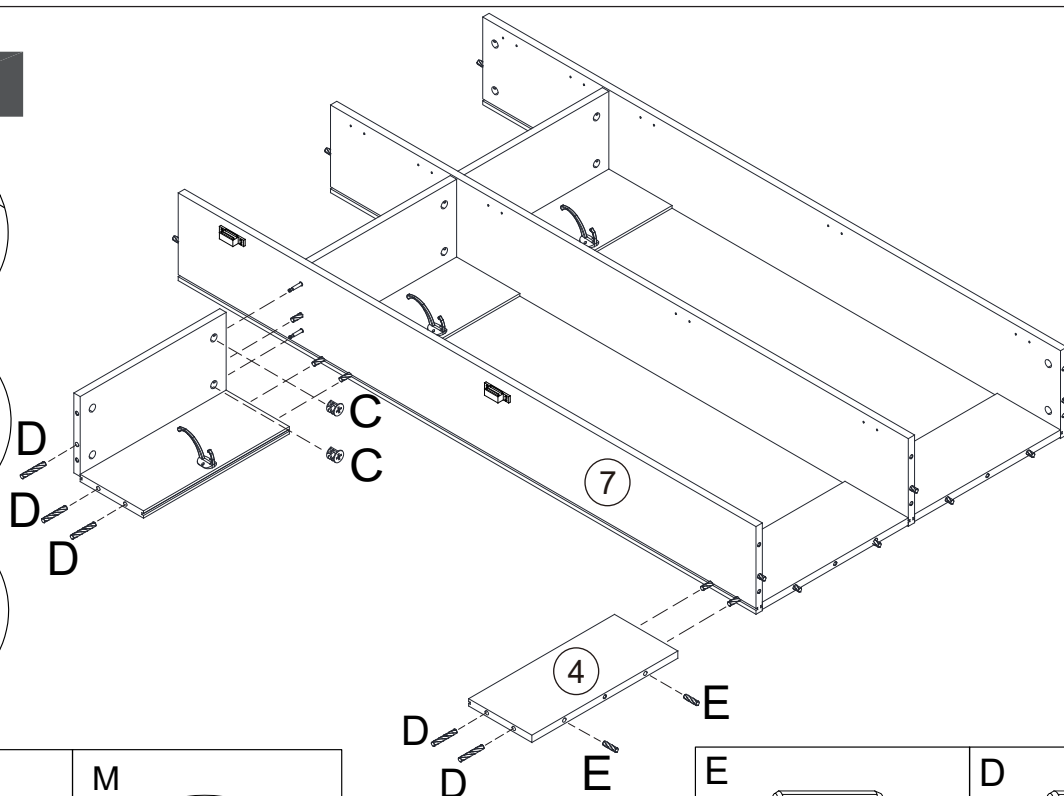
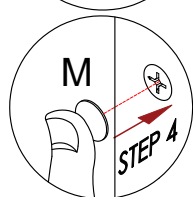
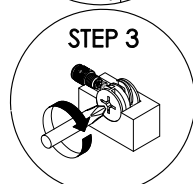
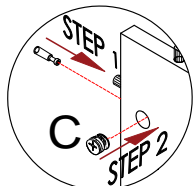

Step 20

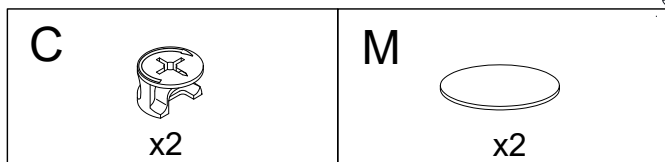
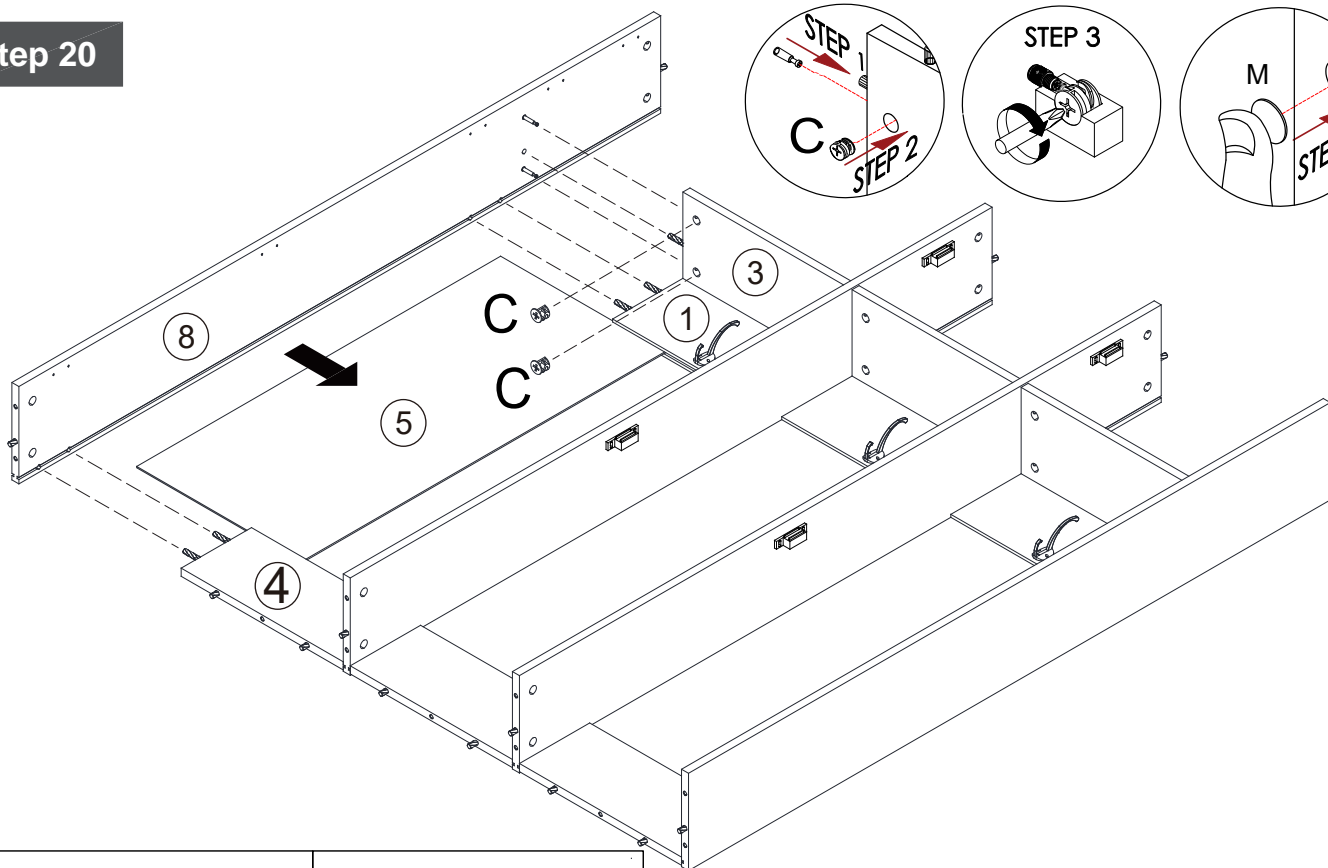
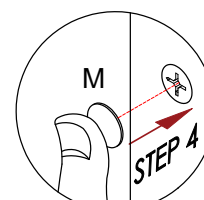
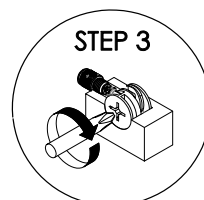
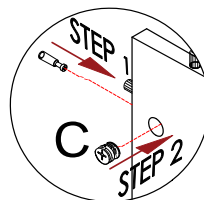

Assembly Instructions

Step 21

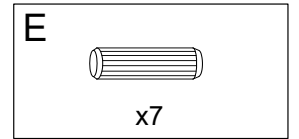
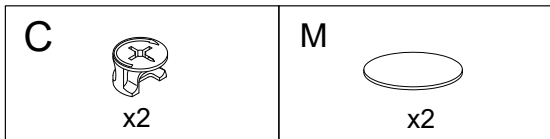
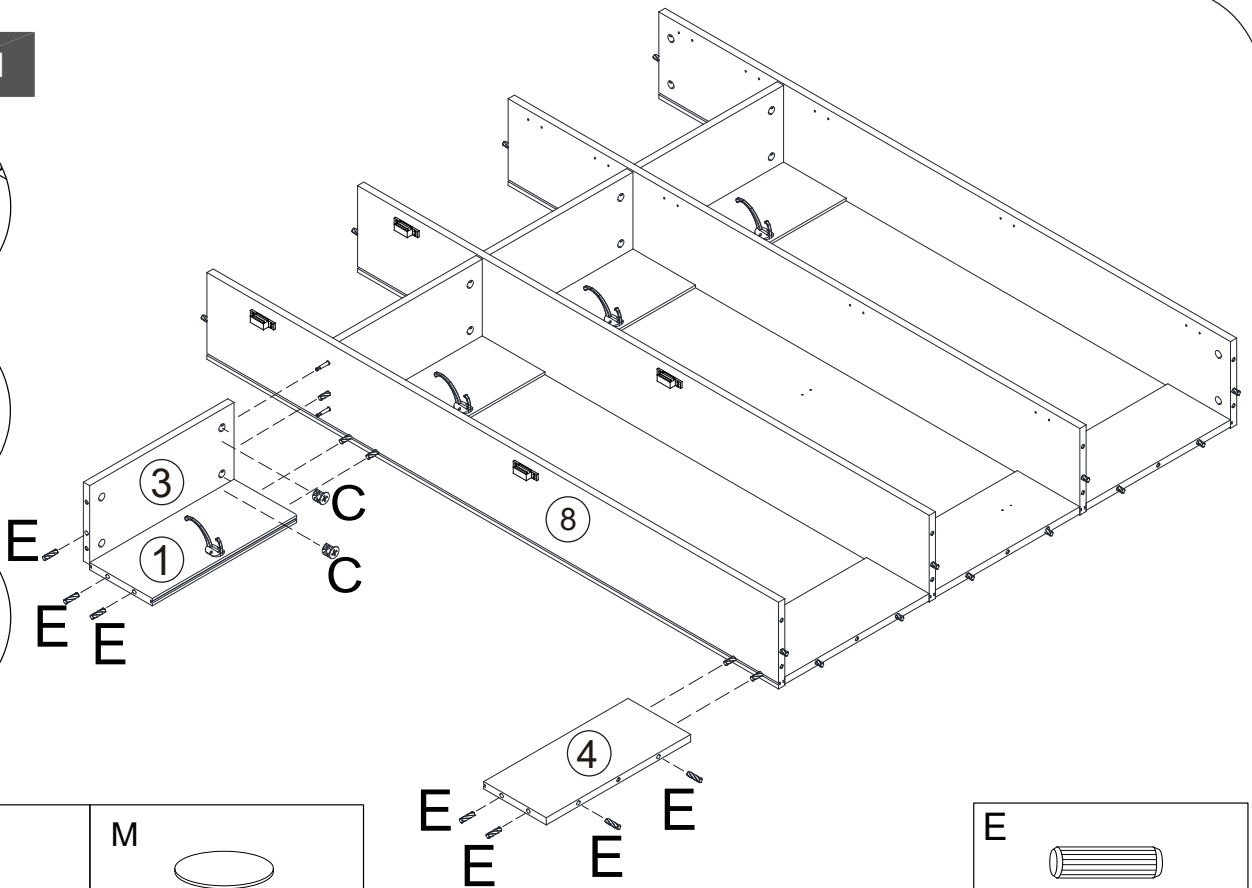
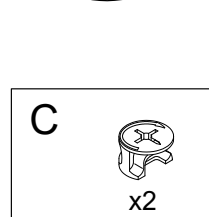
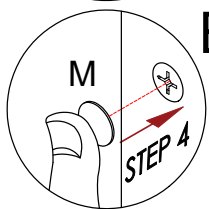
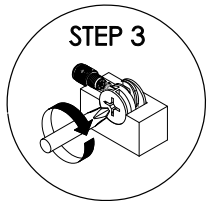
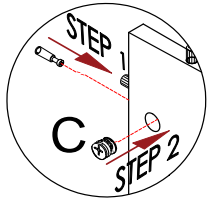

Step 22

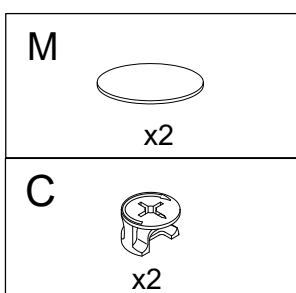
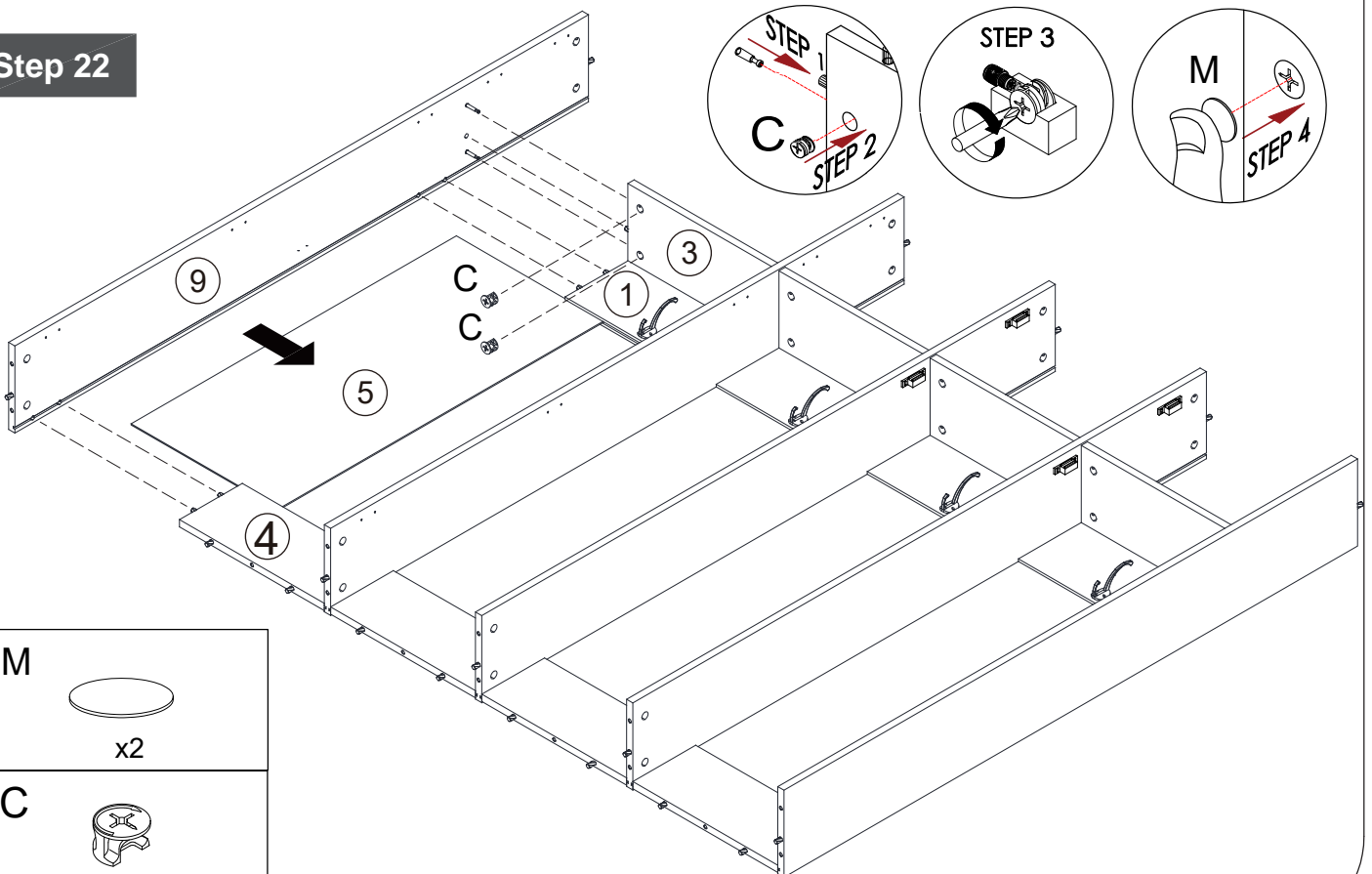
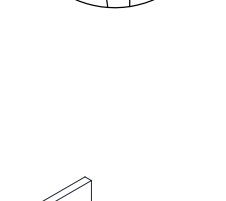
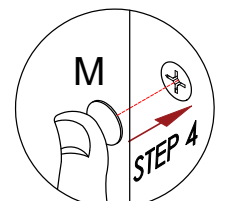
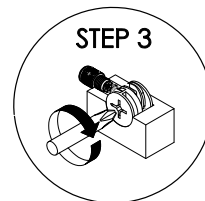
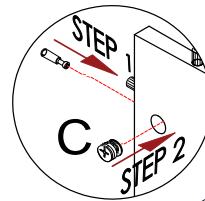

Assembly Instructions

Step 23

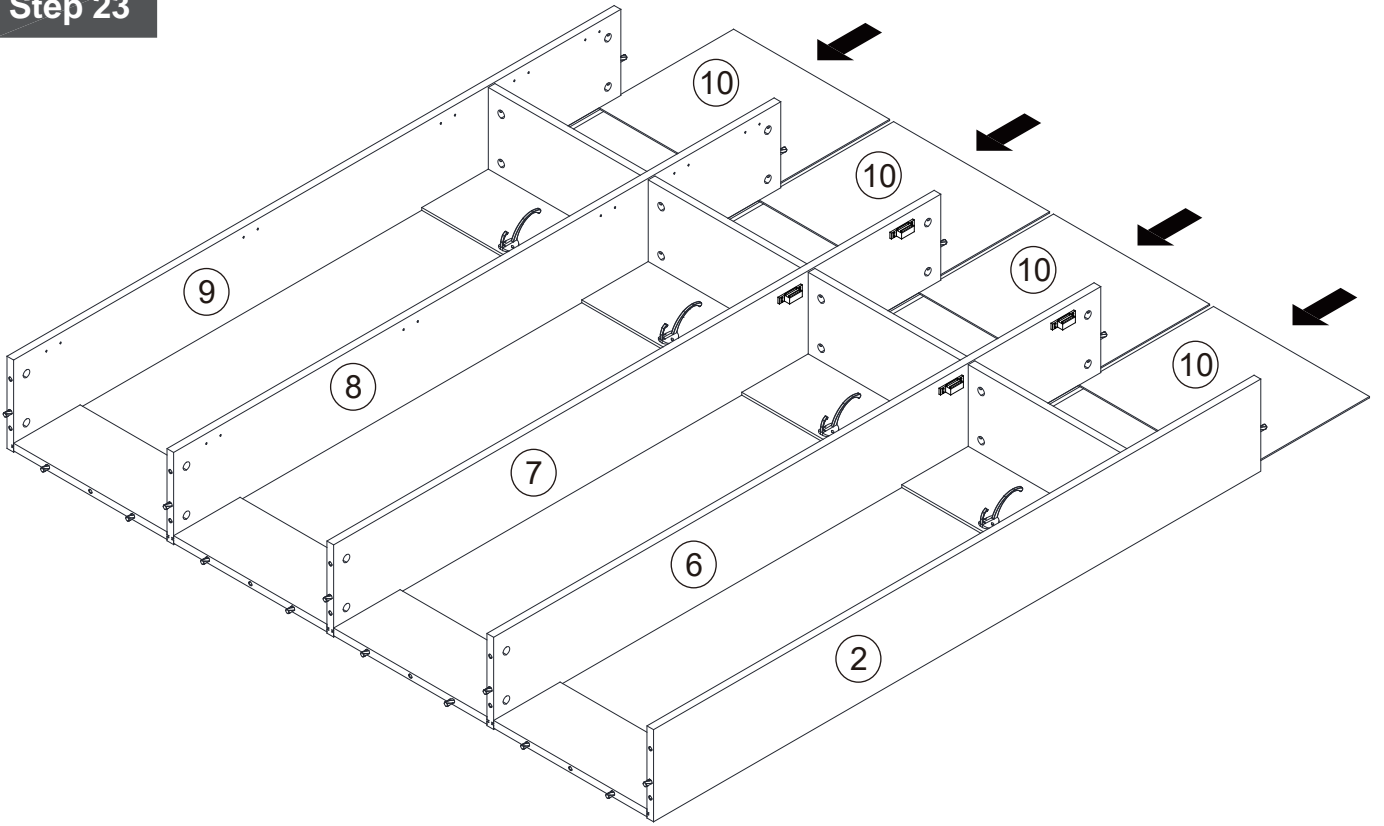

Step 24

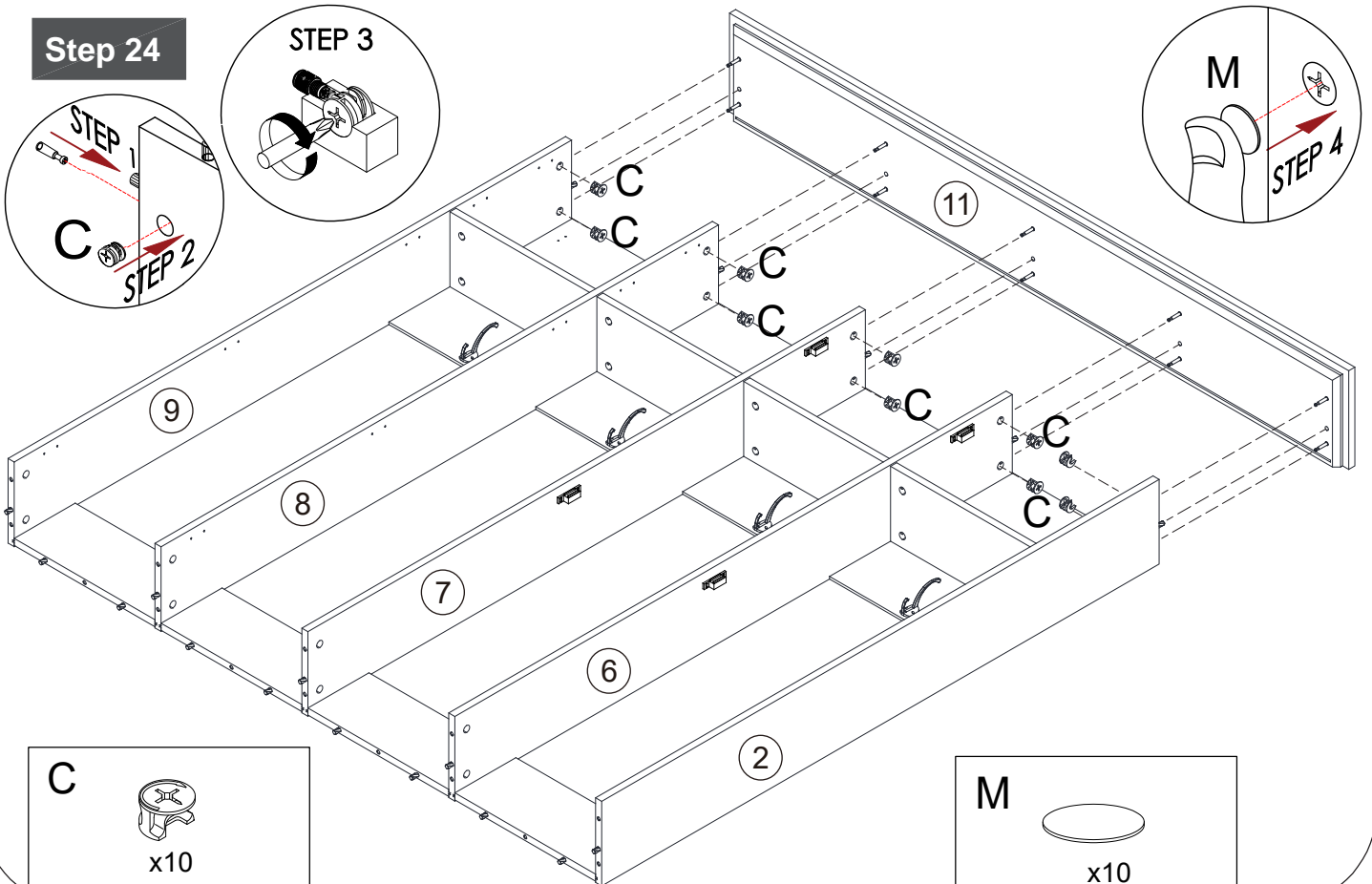

Assembly Instructions

Step 25

STEP 3

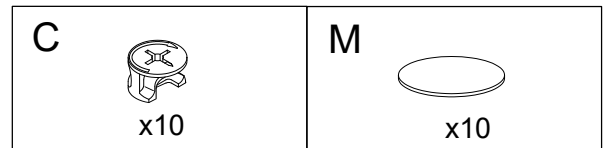
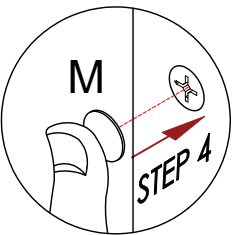
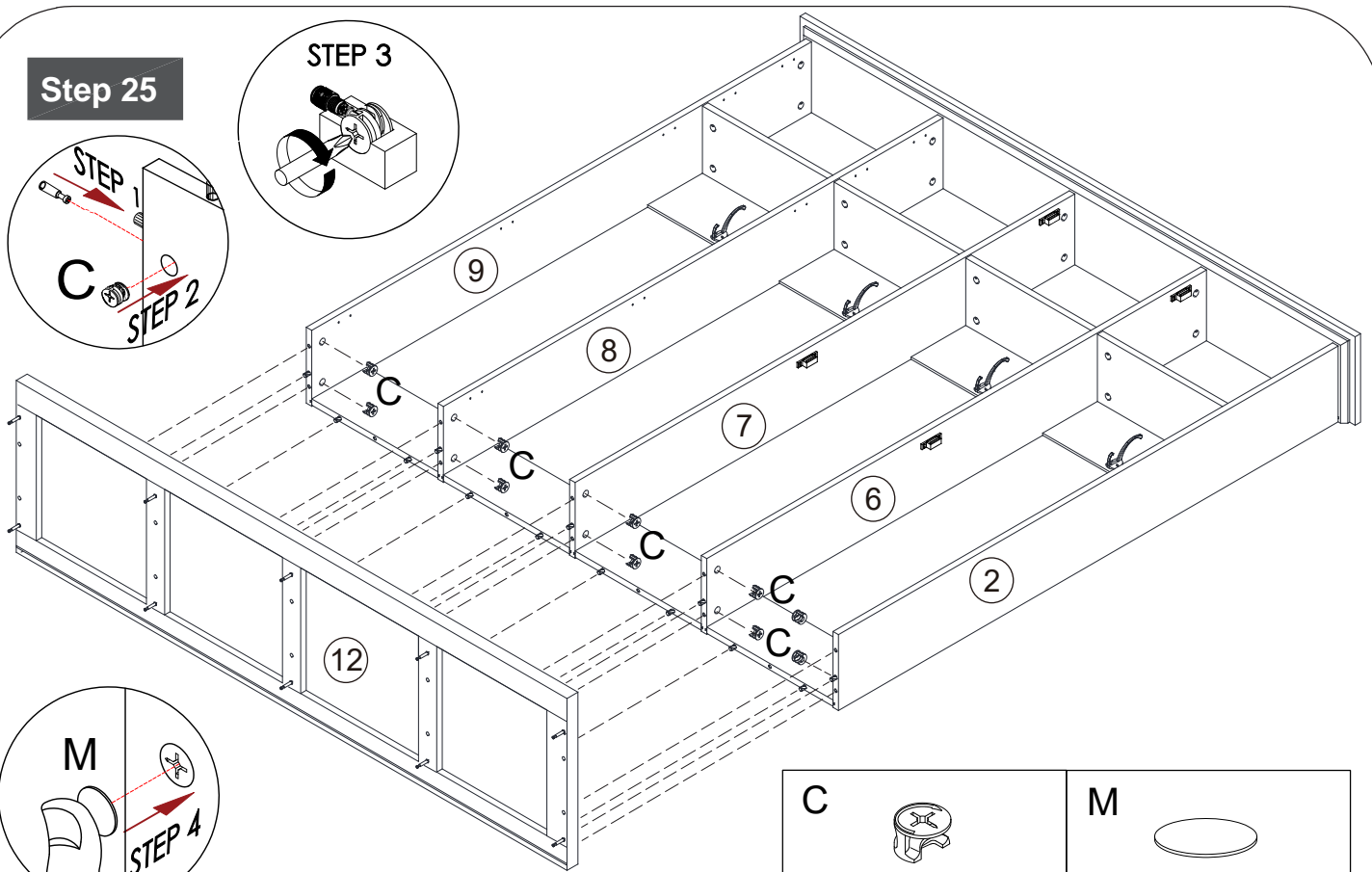
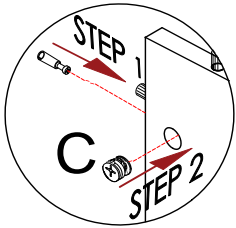
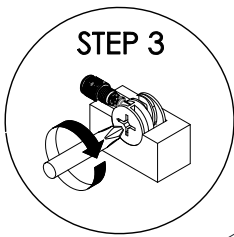

Step 26

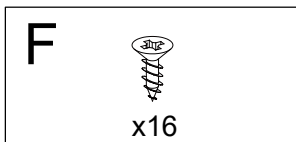
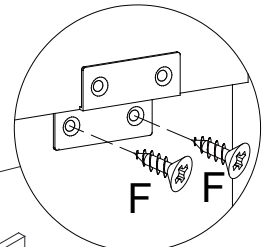
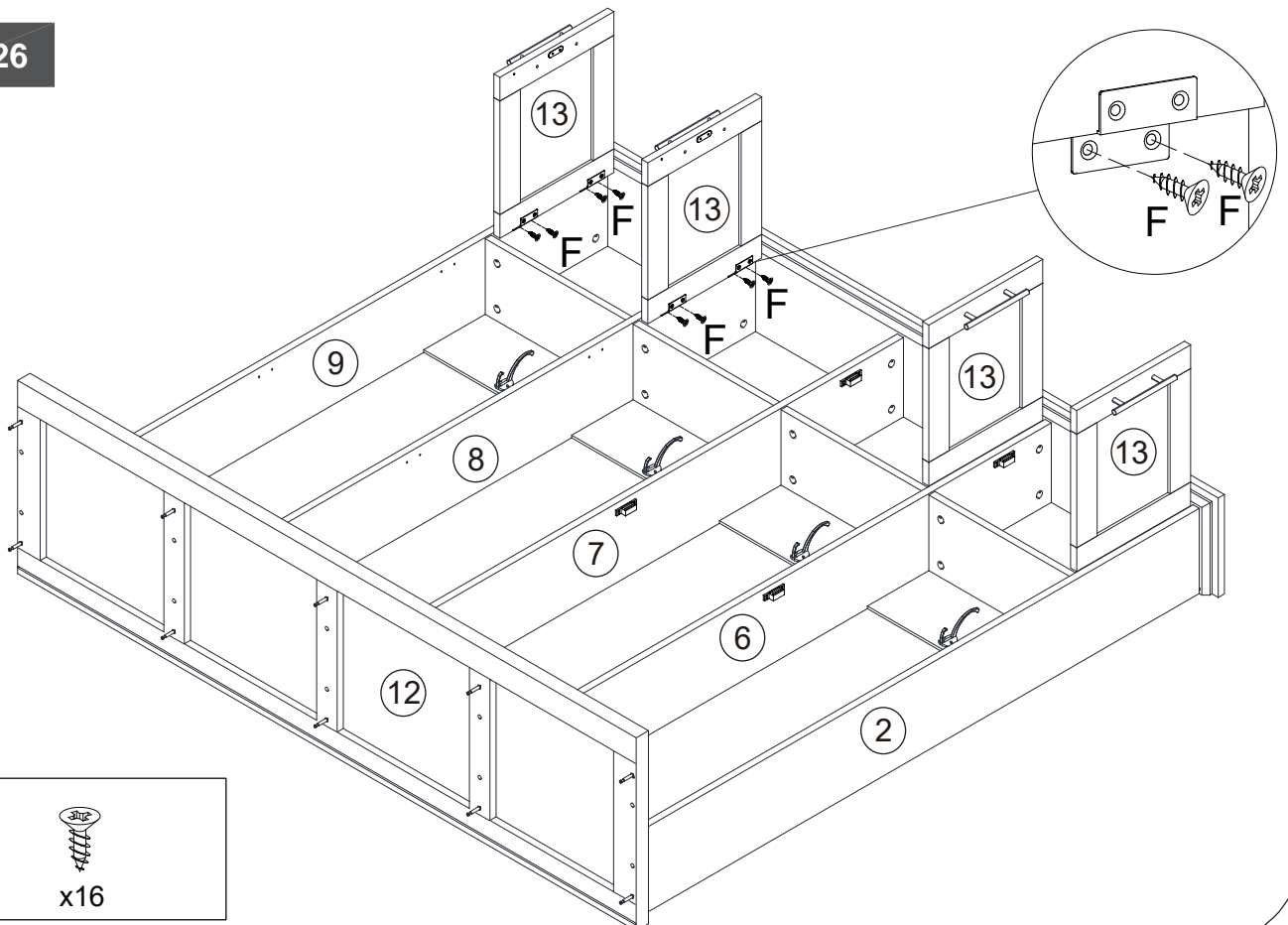

Assembly Instructions

Step 27

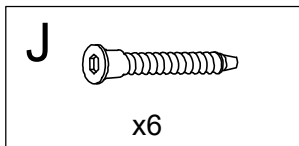
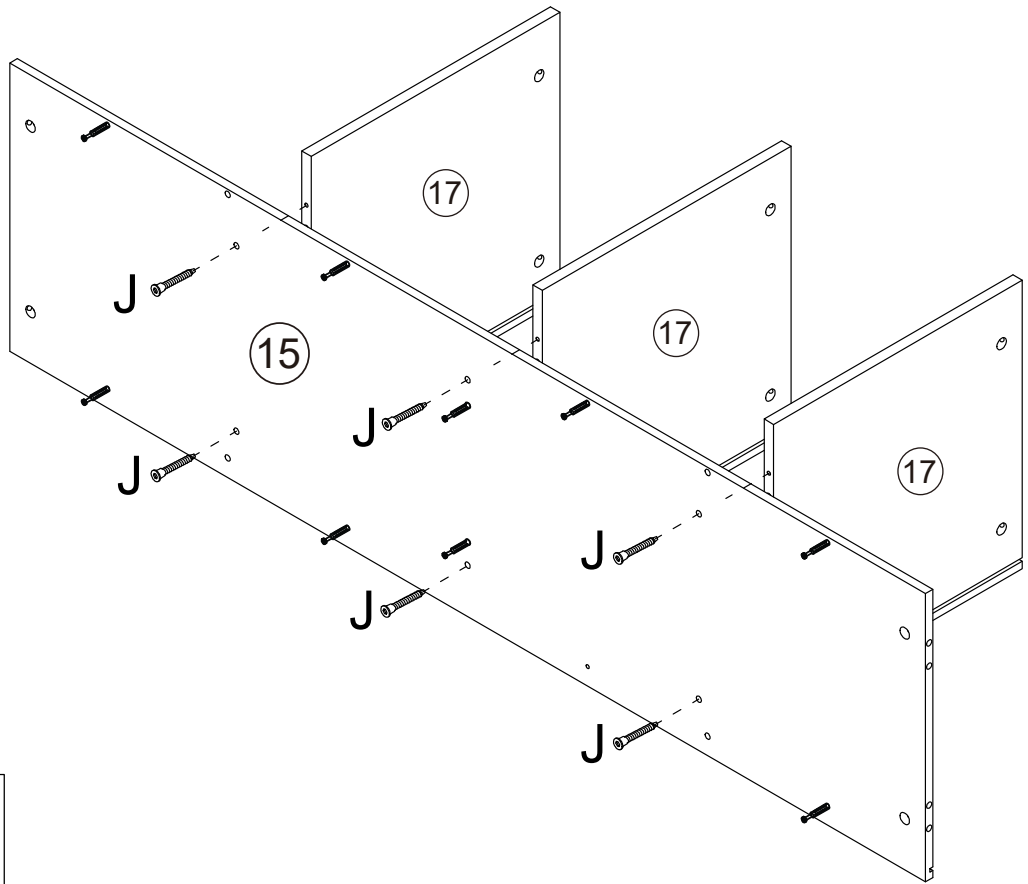

Step 28

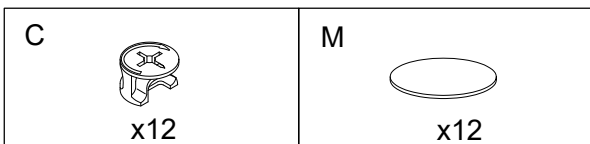
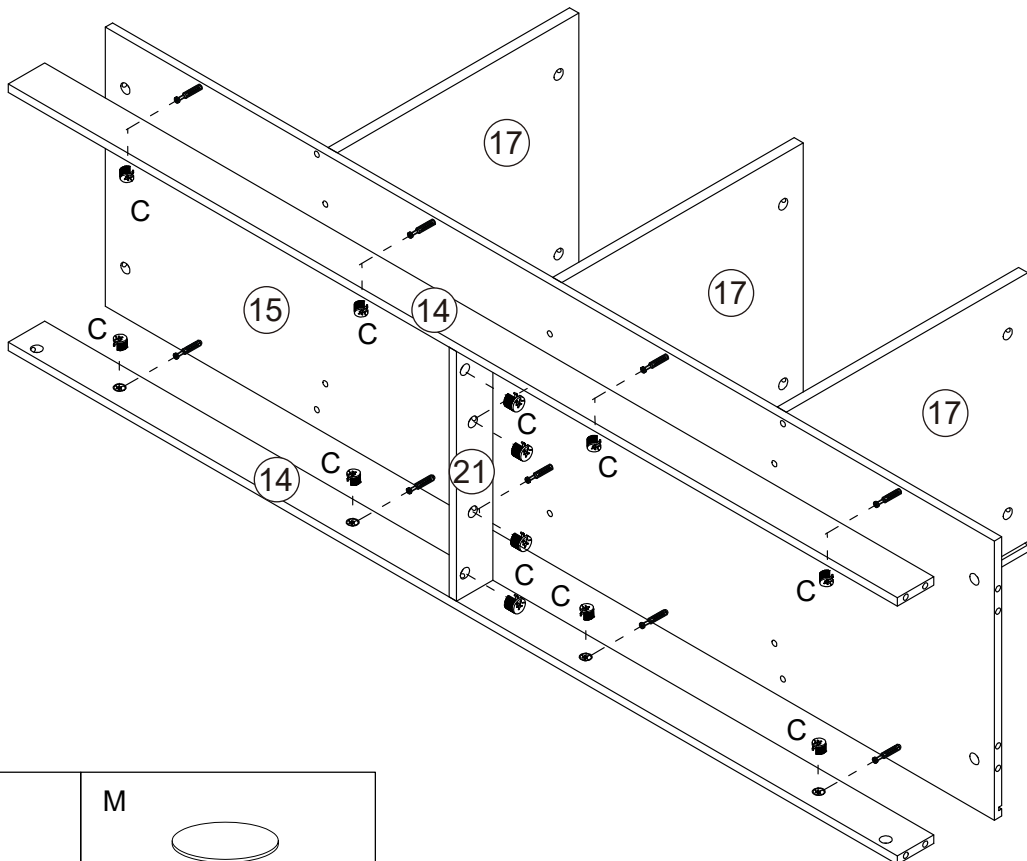
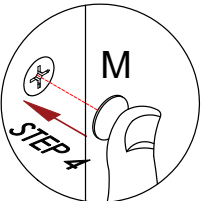
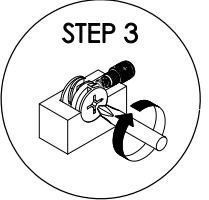
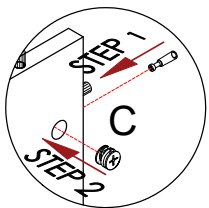

Assembly Instructions

Step 29

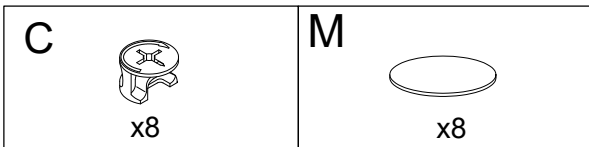
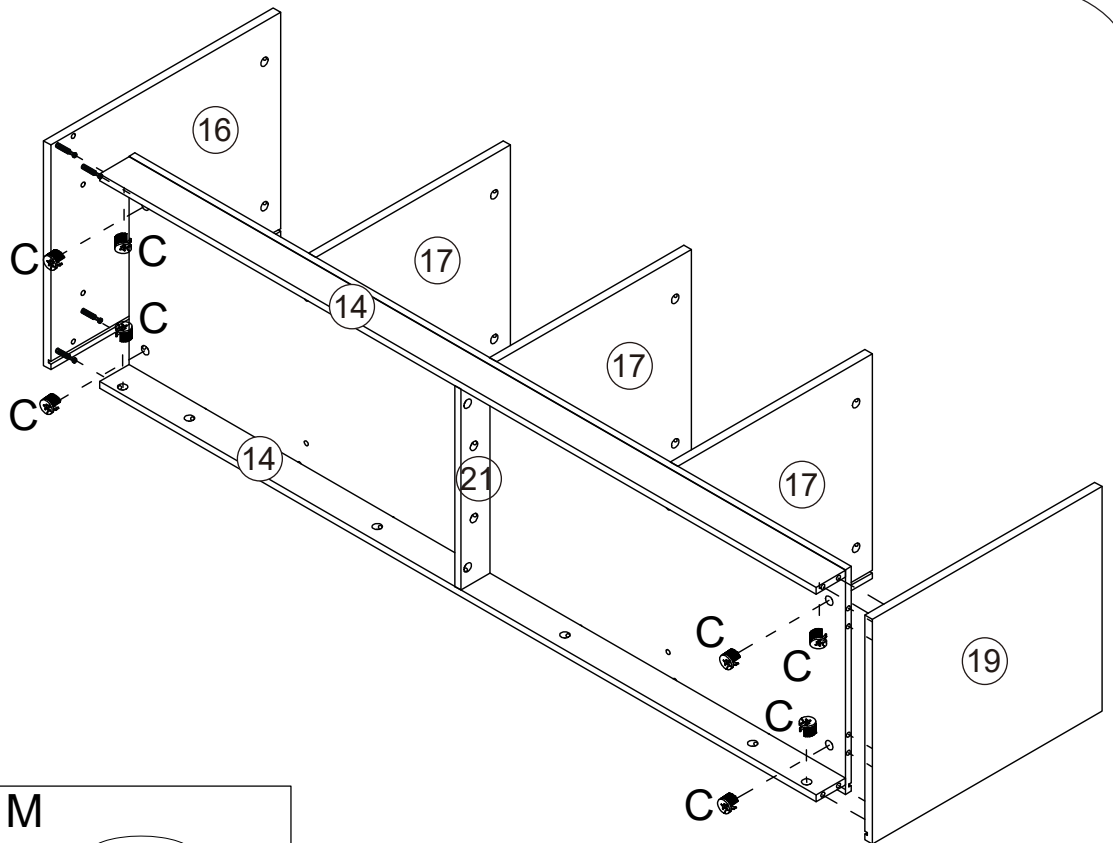
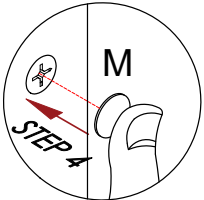
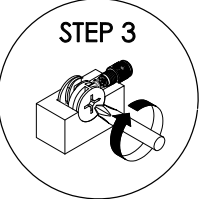
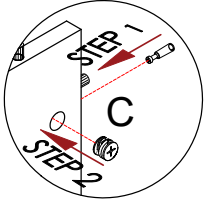

Step 30

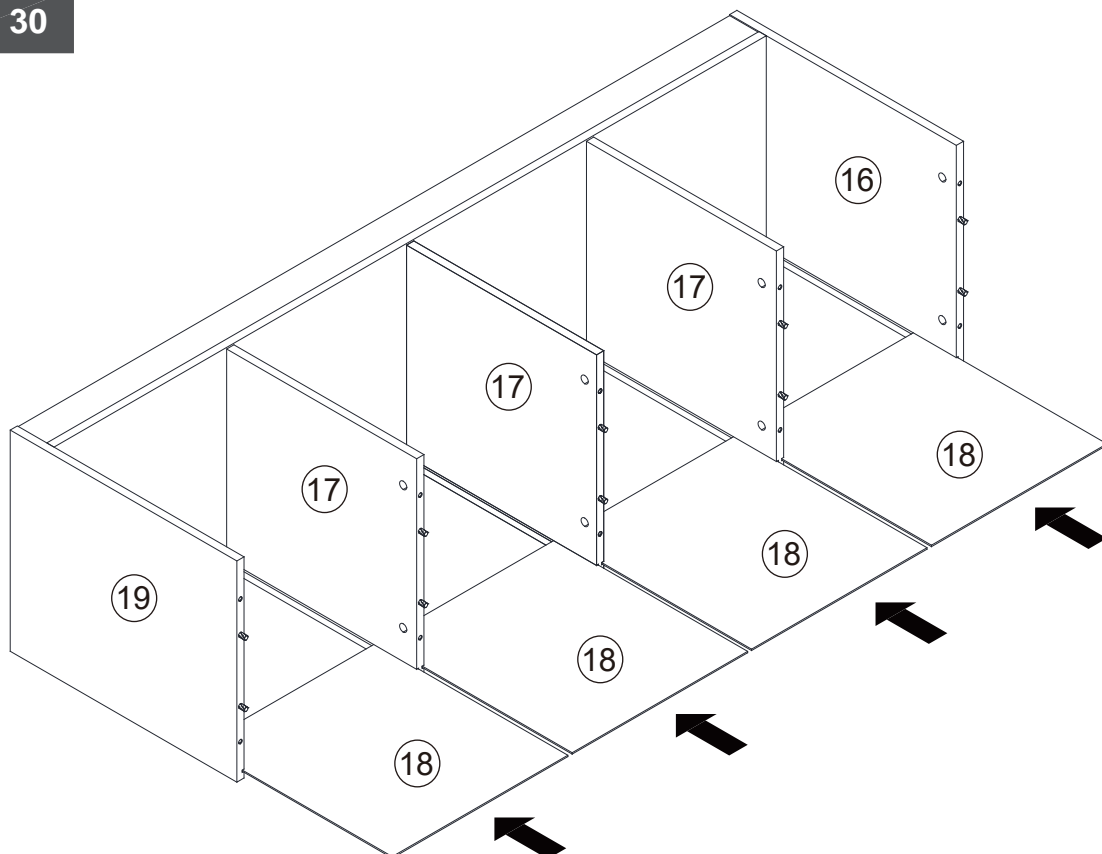

Assembly Instructions

Step 31

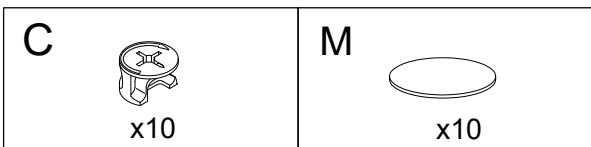
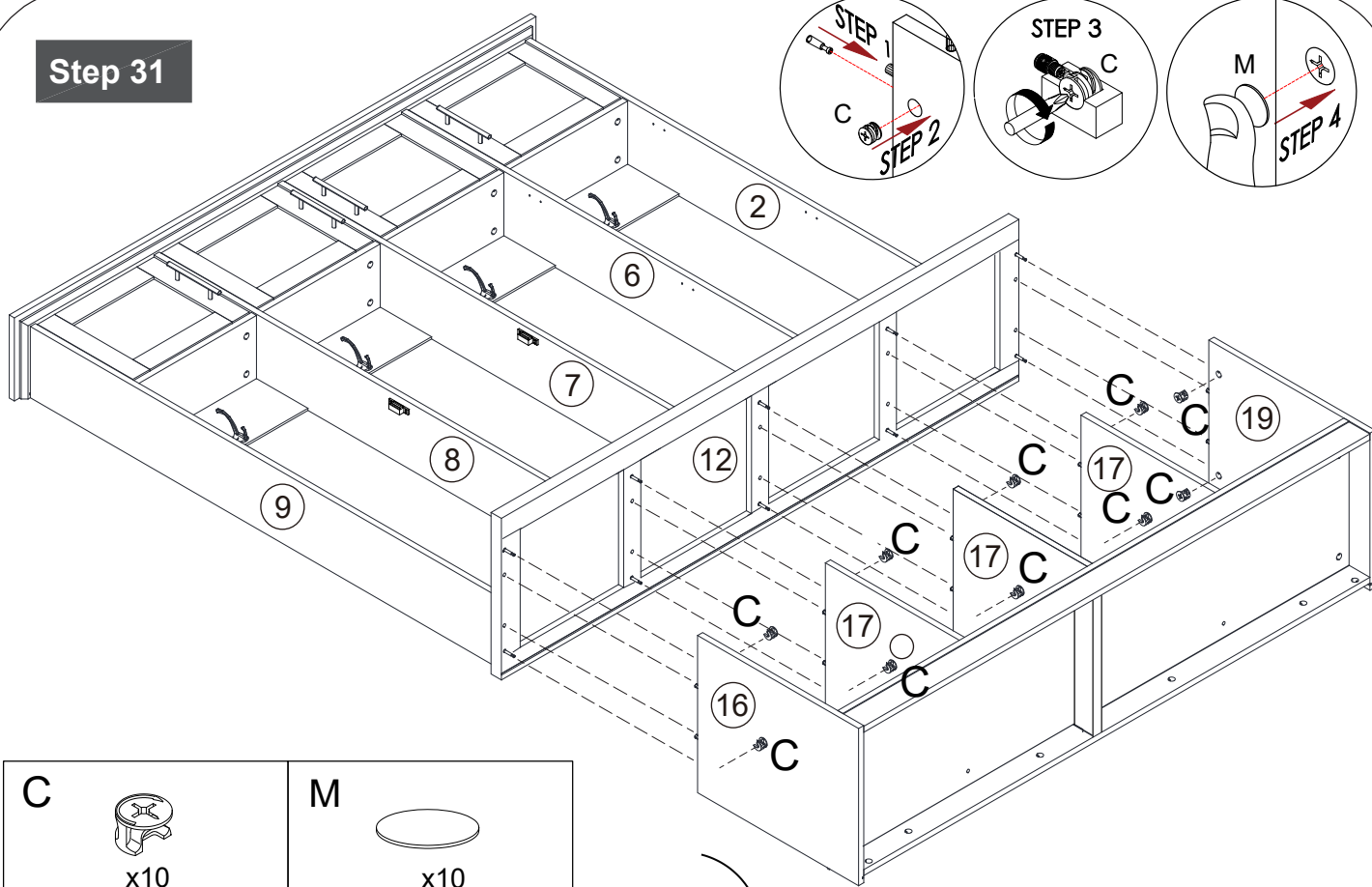

Step 32

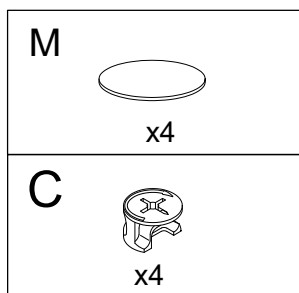
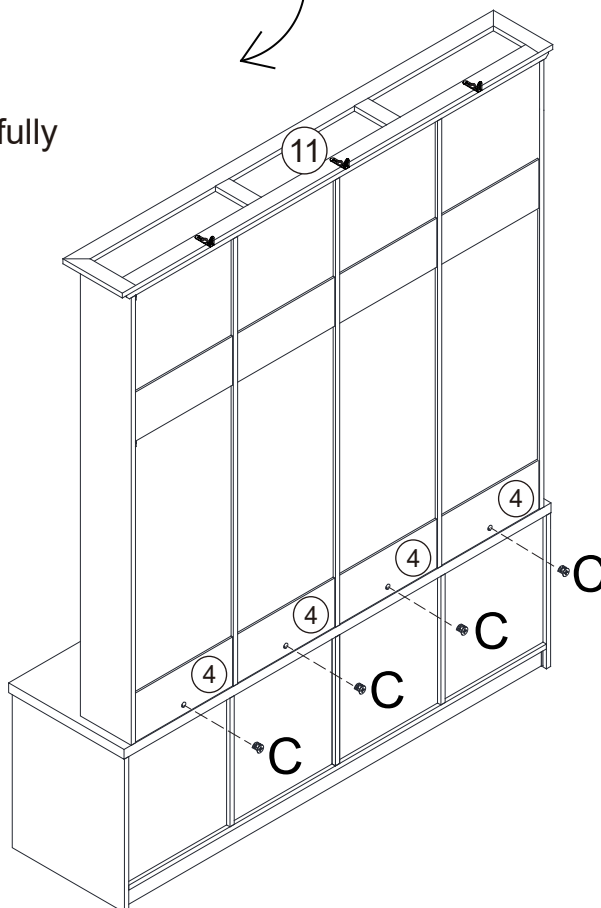

Please stand this product carefully
Need at least three person
flip the cabinet carefully
to standing position

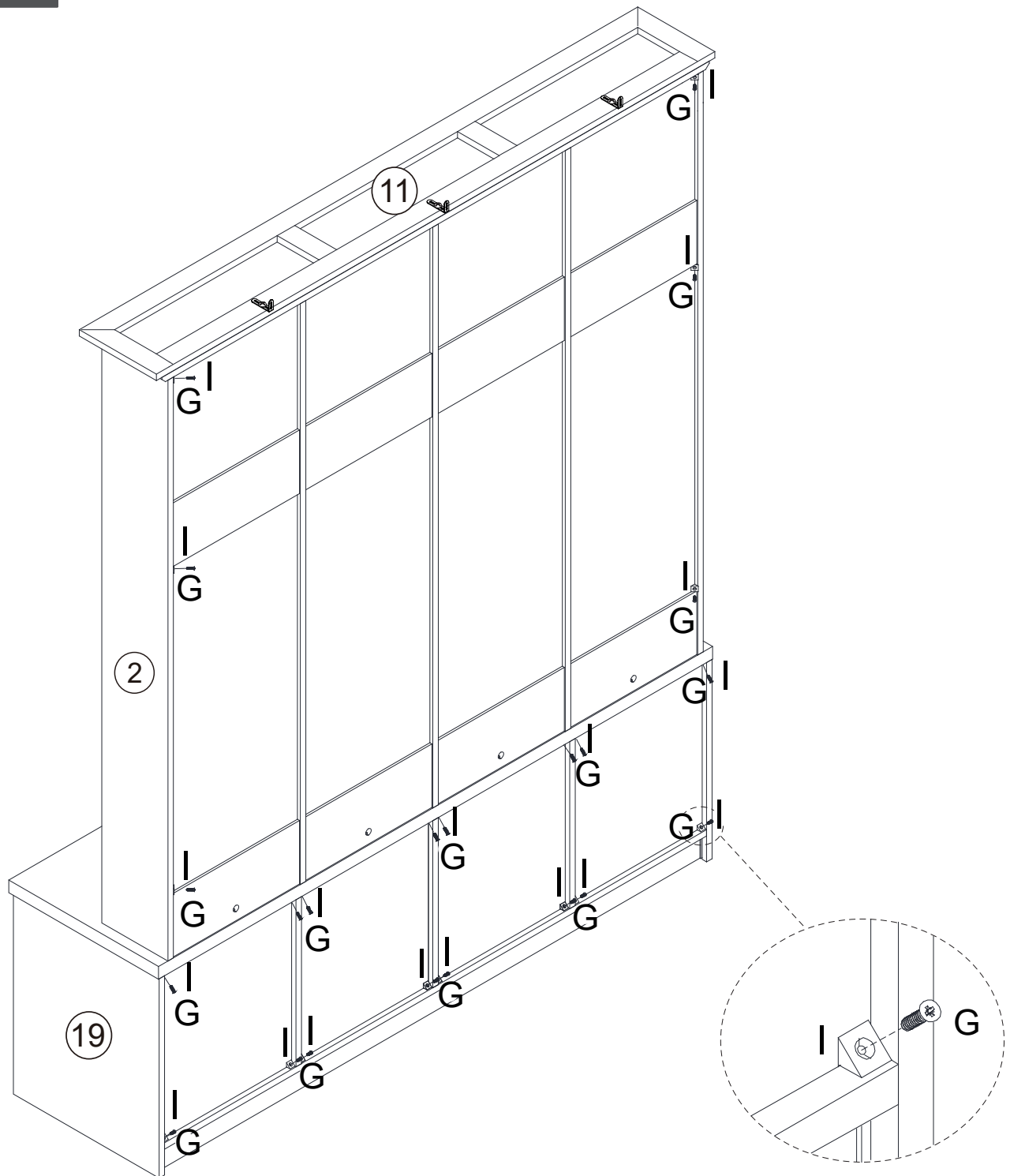

Assembly Instructions

Step 33

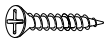

G  x22	I  x22
--	--

Assembly Instructions

Step 34

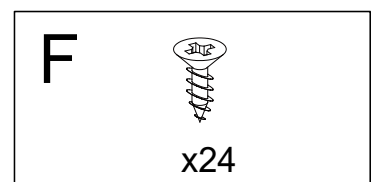
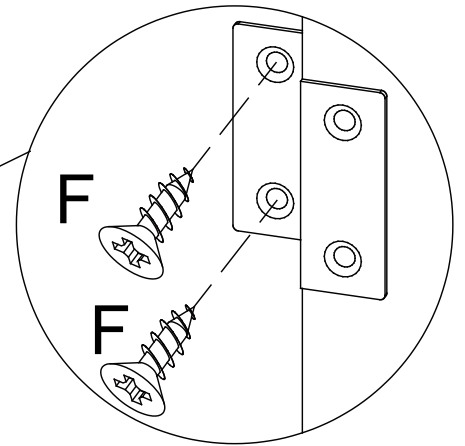
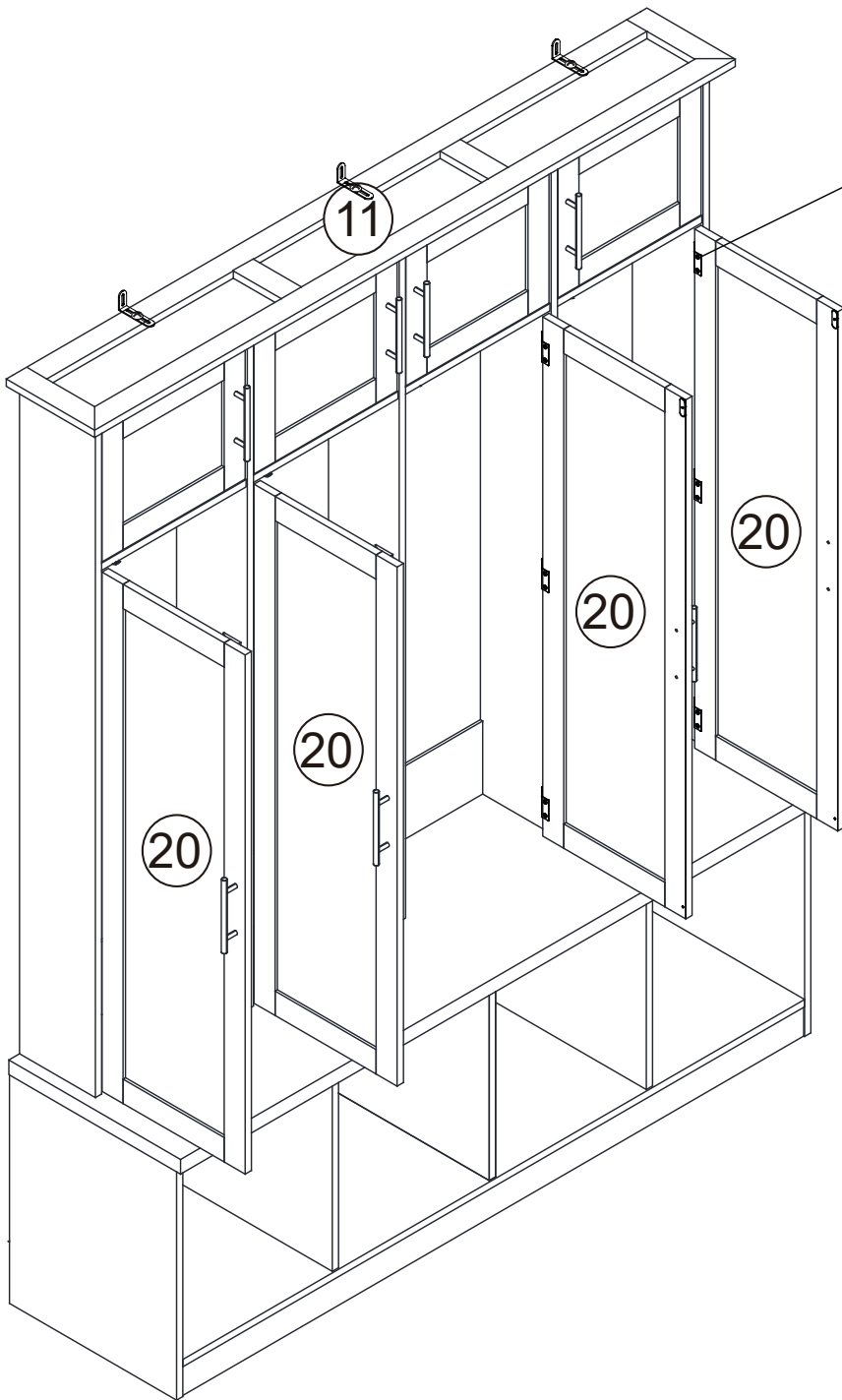

Assembly Instructions

Step 35

WALL

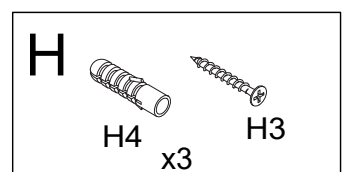
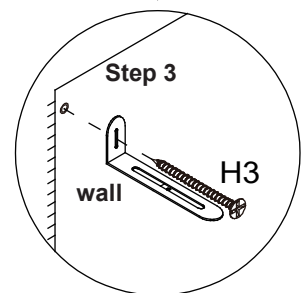
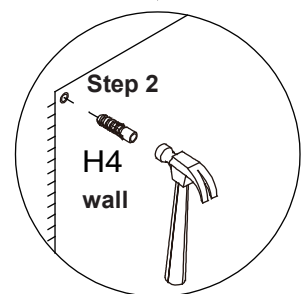
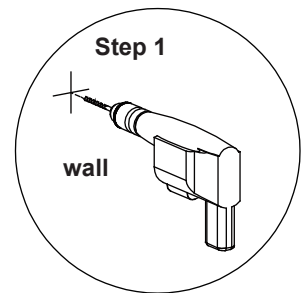
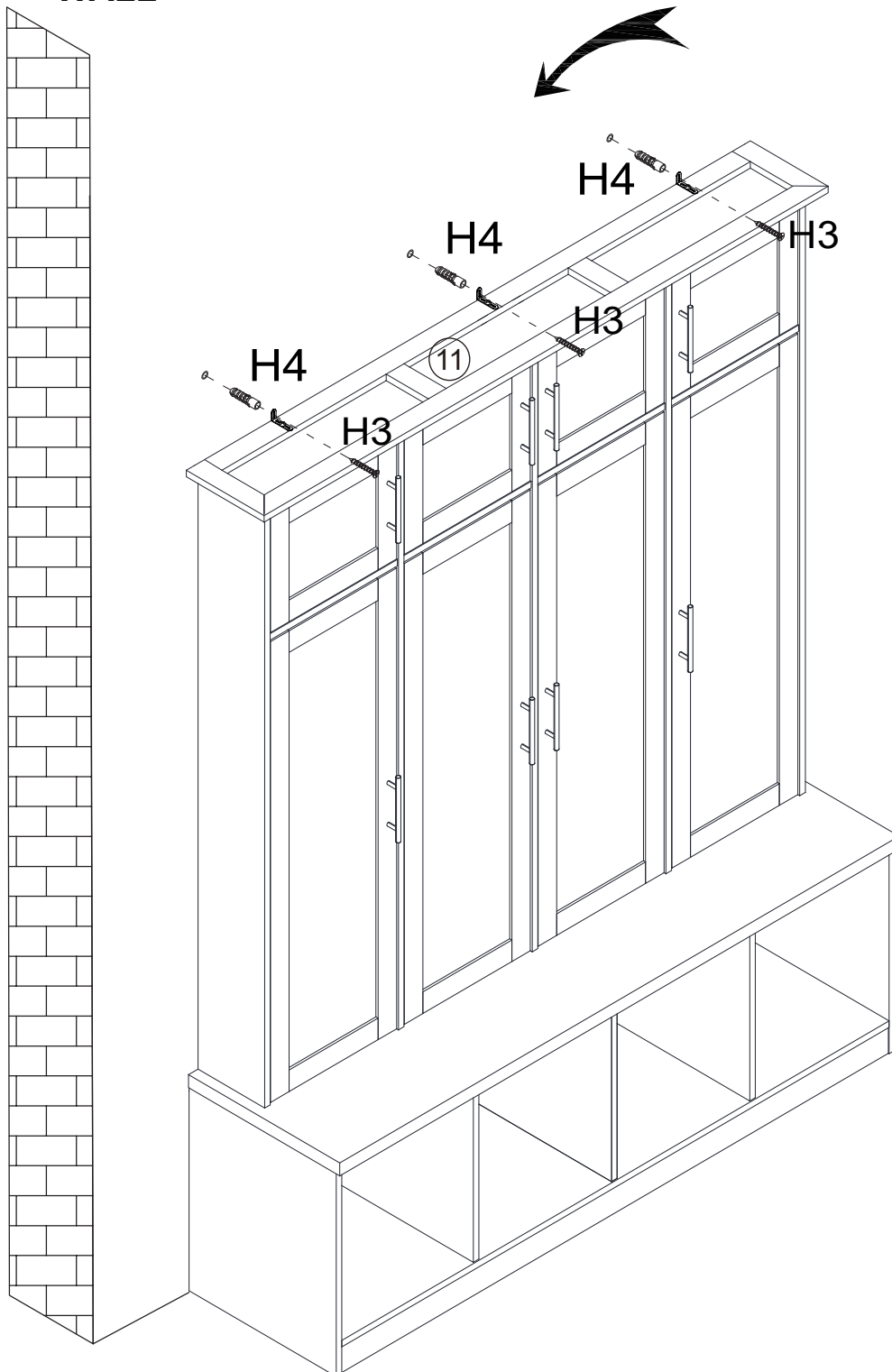

Assembly Instructions

Finish

