

ASSEMBLE INSTRUCTIONS

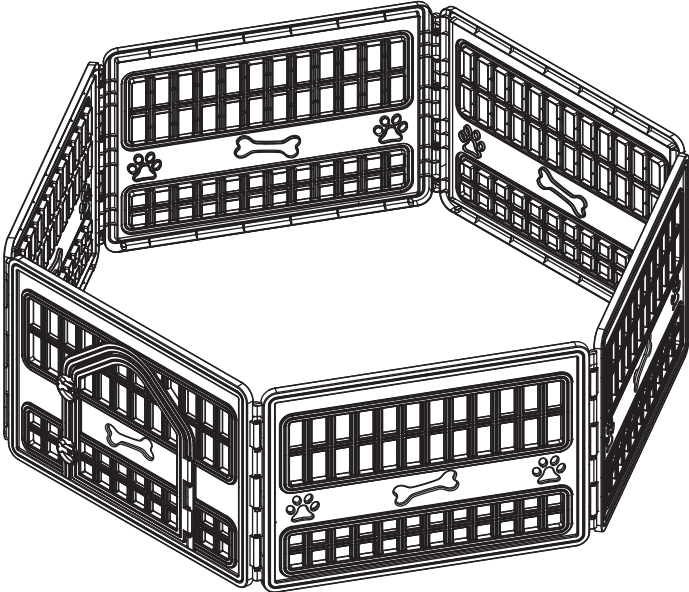

IMPORTANT

Once installed, the product cannot be detached. Strictly follow each step in the installation manual.

- Gather and organize all required parts prior to assembly. If you have any problems or discover any missing parts, please contact customer service.
- Some parts may contain sharp edges. Wear protective gloves if necessary during assembly.

CARE & SAFETY

- Assemble on a flat, clean and soft surface.
- In case of fire, do not attempt to extinguish any burning polypropylene with water.
- Wear safety-goggles and always follow the manufacturer's instructions when using power tools.
- During installation, please refer to the accessories guide to ensure that they are installed in the correct directions.
- Do not stand on the lid.

PARTS LIST

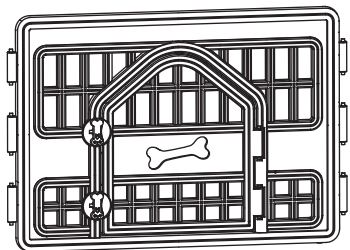

A(X1)

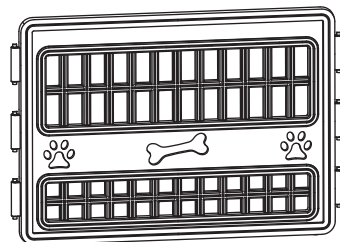

C(X2)

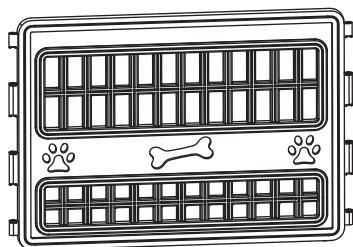

D(X3)



(X12)

1

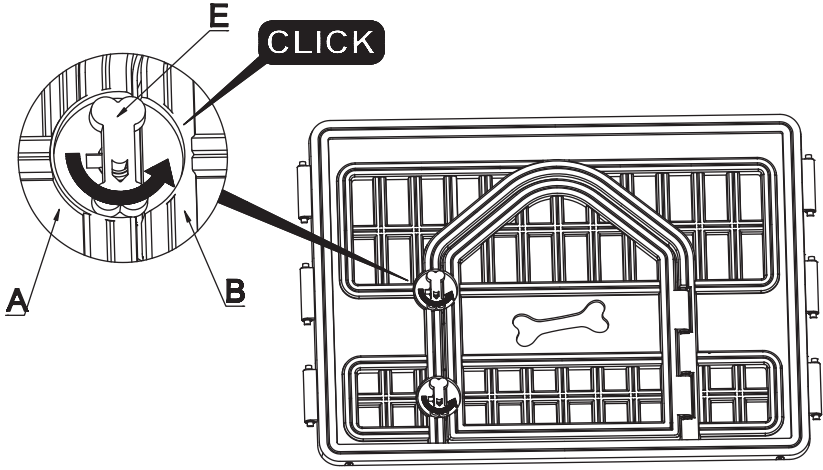
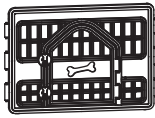

2



A(X1)

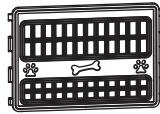

D(X2)

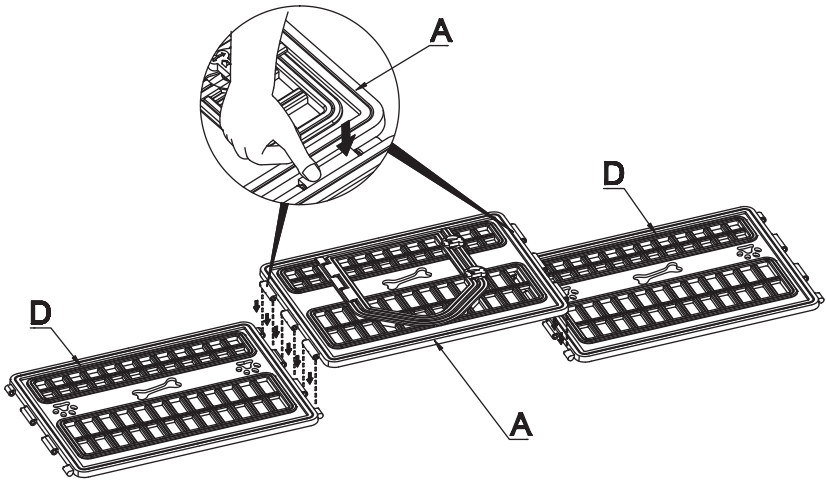

3

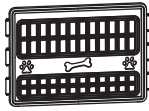

C(X1)

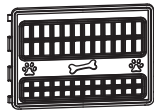

D(X1)

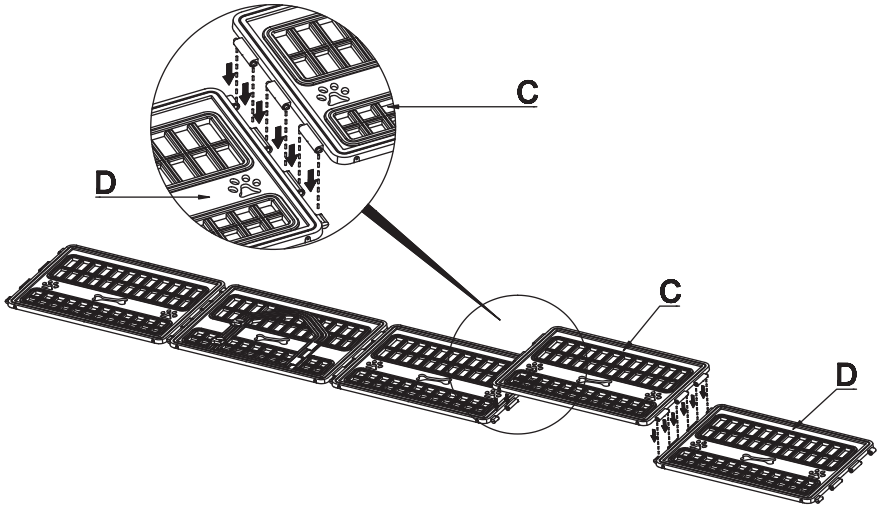

4

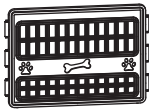

C(X1)

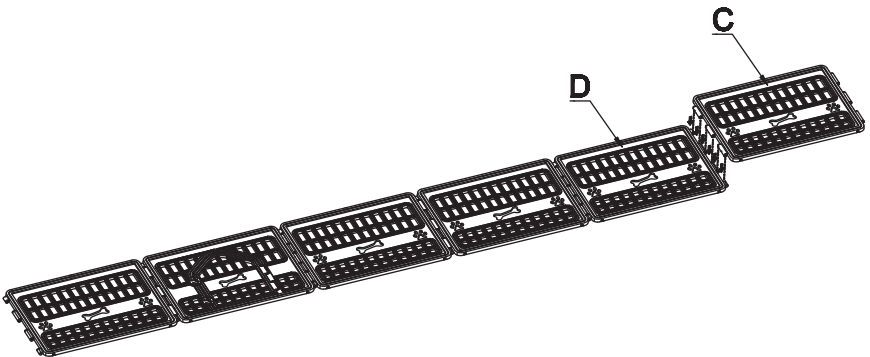

5

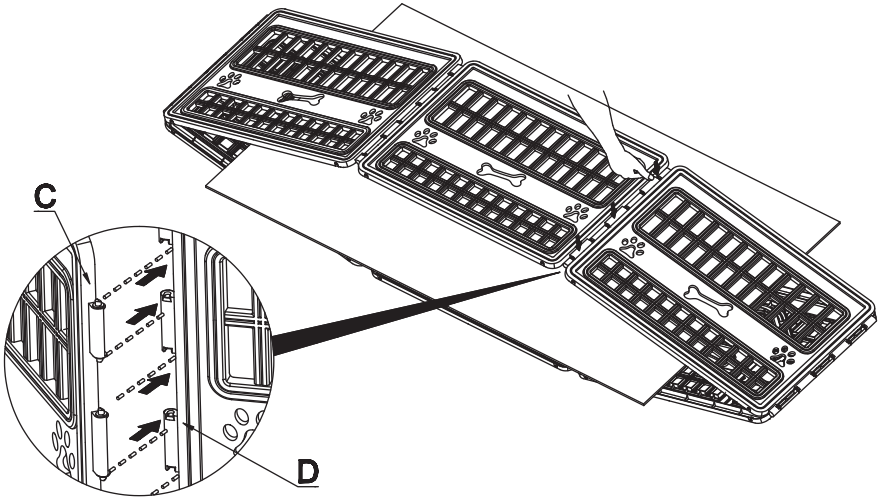

6



(X12)

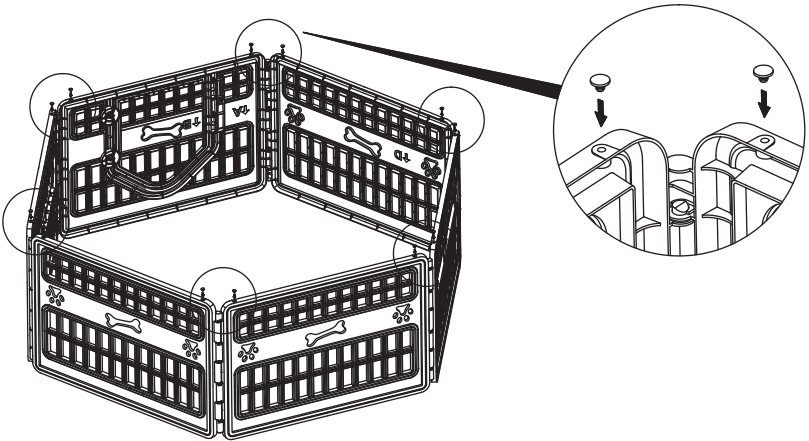

7

