

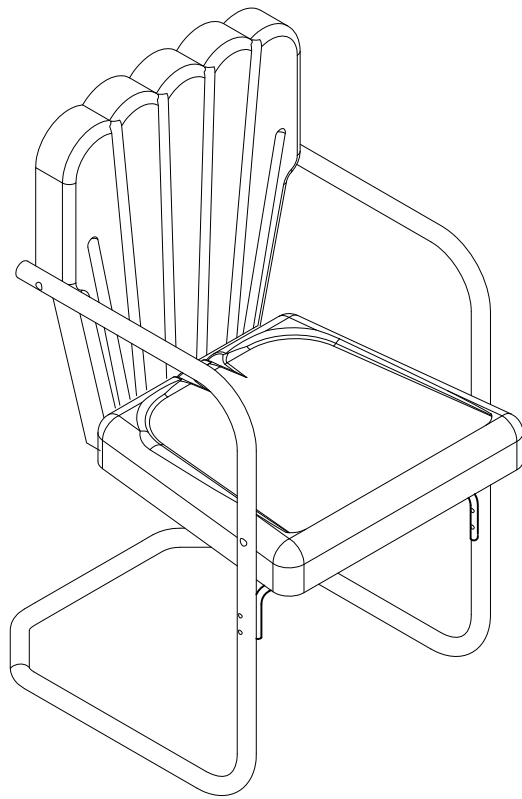

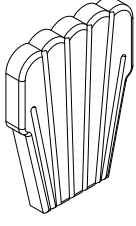

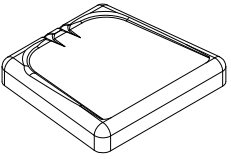

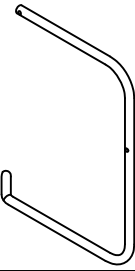
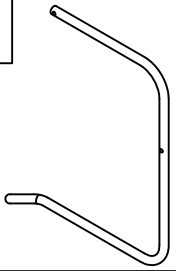
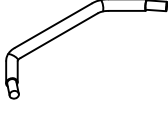
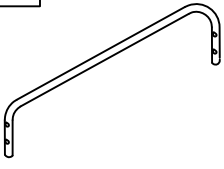

# Metal Chair

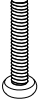

# PART LIST

<b>A</b> 	<b>B</b> 	<b>C</b> 	<b>D</b> 	<b>E</b> 
Chair Back 1 PC	Chair Seat 1 PC	Left Support Leg 1 PC	Right Support Leg 1 PC	Leg Connector 1 PC
<b>F</b> 				
Crossbar 1 PC				

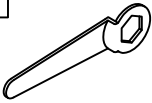
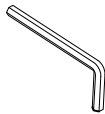
# HARDWARE LIST

<b>#1</b> 	<b>#2</b> 	<b>#3</b> 	<b>#4</b> 	<b>#5</b> 
M6X40mm Long Bolt 4 PCS (Extra 1)	M6X38mm Medium Bolt 4 PCS (Extra 1)	M6X13mm Short Bolt 3 PCS	Hex Nut 11 PCS (Extra 2)	Flat Washer 18 PCS (Extra 4)
<b>#6</b> 	<b>#7</b> 	<b>#8</b> 	<b>#9</b> 	
Wrench 1 PC	Allen Wrench 1 PC	Plastic Washer 4 PCS	Round Plastic Washer 8 PCS	

NOTE: We recommend at least two people work together to assemble unit.

**Step 1.** Lay chair seat (part B) down on a soft flat surface, such as carpet, as shown below. Attach chair back (part A) to chair seat (part B) using short bolts (part #3), hex nuts (part #4), flat washers (part #5), wrench (part #6) and allen wrench (part #7).

**NOTE:** Please do not fully tighten bolts until unit is fully assembled.

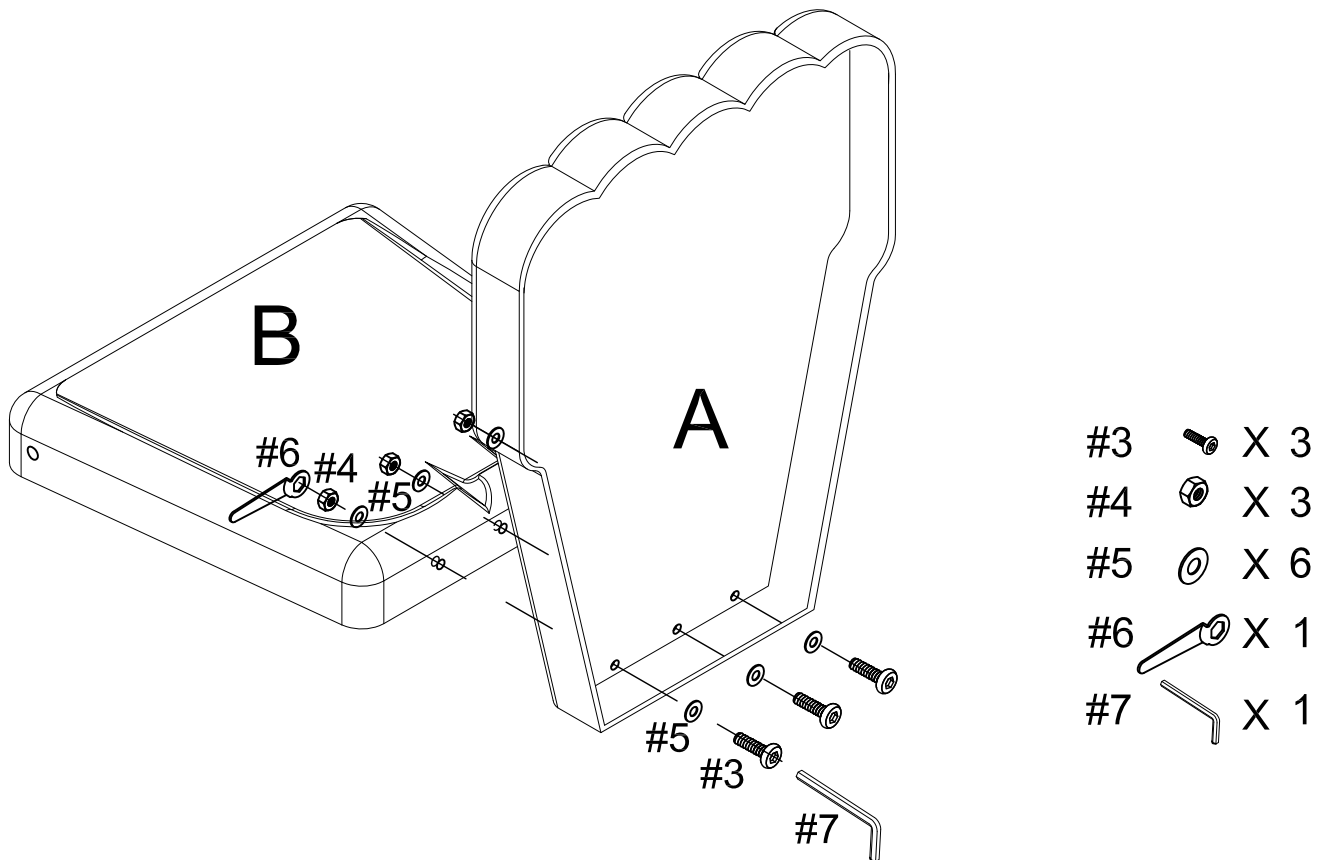

**Step 2.** Attach left support leg (part C) and right support leg (part D) to leg connector (part E).

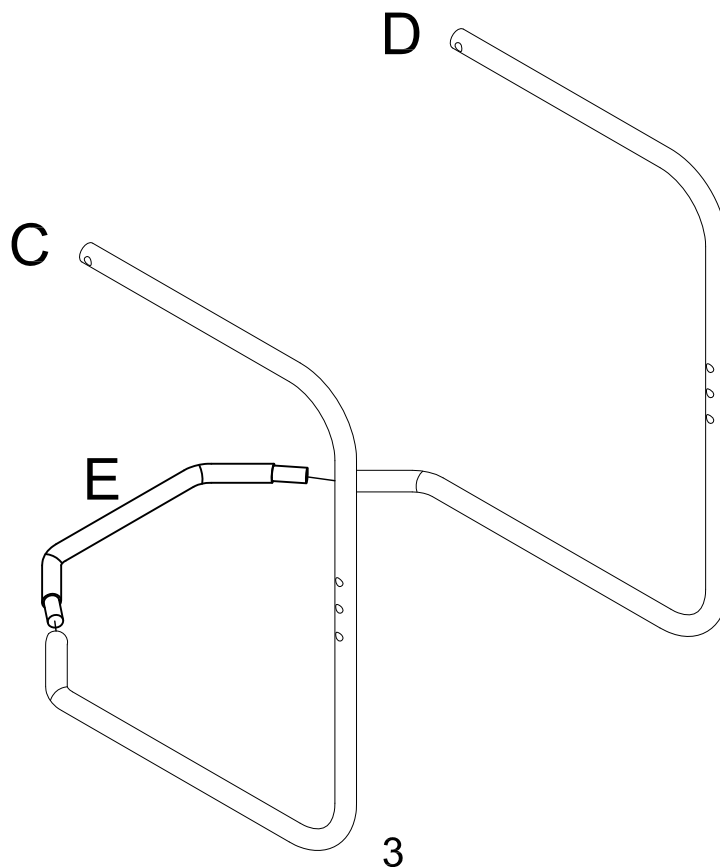

**Step 3.** Attach support legs (parts C & D) to chair back (part A) and chair seat (part B) using long bolts (part #1), Round Plastic Washer (part #9), hex nuts (part #4), flat washers (part #5), plastic washers (part #8), wrench (part #6) and allen wrench (part #7).



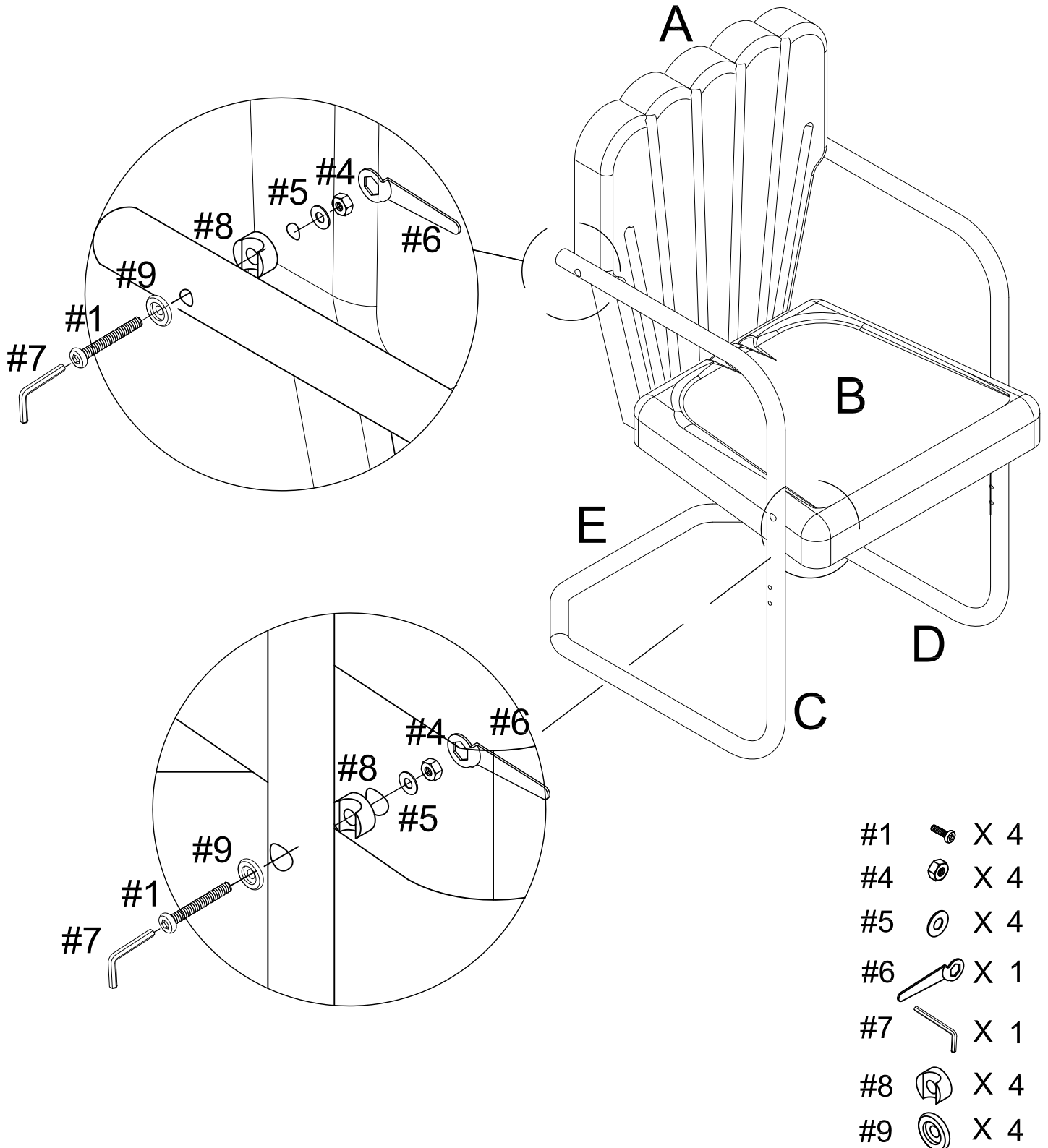



**NOTE:** Please do not fully tighten bolts until unit is fully assembled.

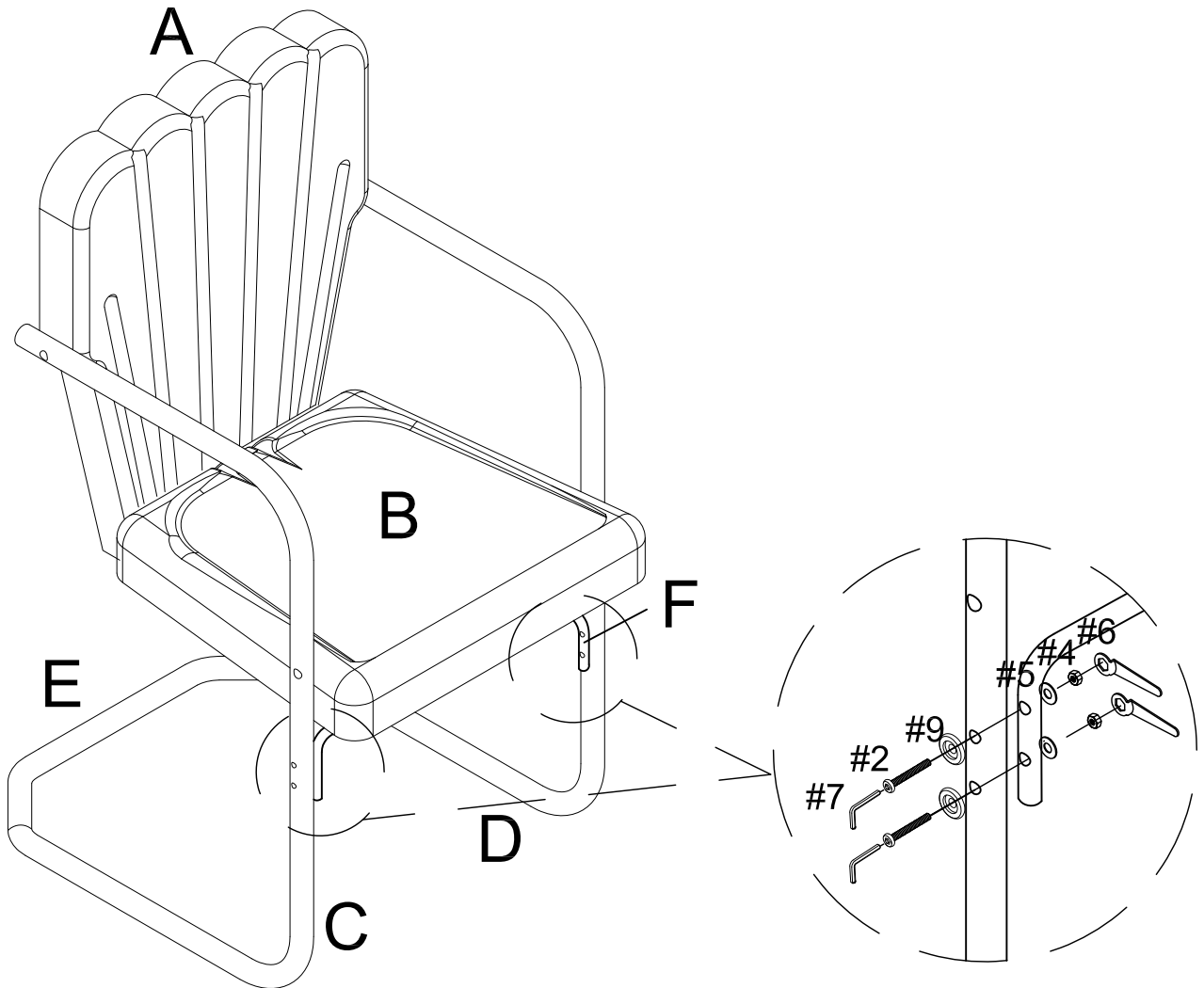

**Step 4.** Attach crossbar (part F) to left support leg (part C) and right support leg (part D) using medium bolts (part #2), Round Plastic Washer (part #9), hex nuts (part #4), flat washers (part #5), wrench (part #6) and allen wrench (part #7).

**NOTE:** Please fully tighten all bolts at this time.



- |    |   |     |
|----|---|-----|
| #2 |  | X 4 |
| #4 |  | X 4 |
| #5 |  | X 4 |
| #6 |  | X 1 |
| #7 |  | X 1 |
| #9 |  | X 4 |