

# MANUAL INSTRUCTION

tea table

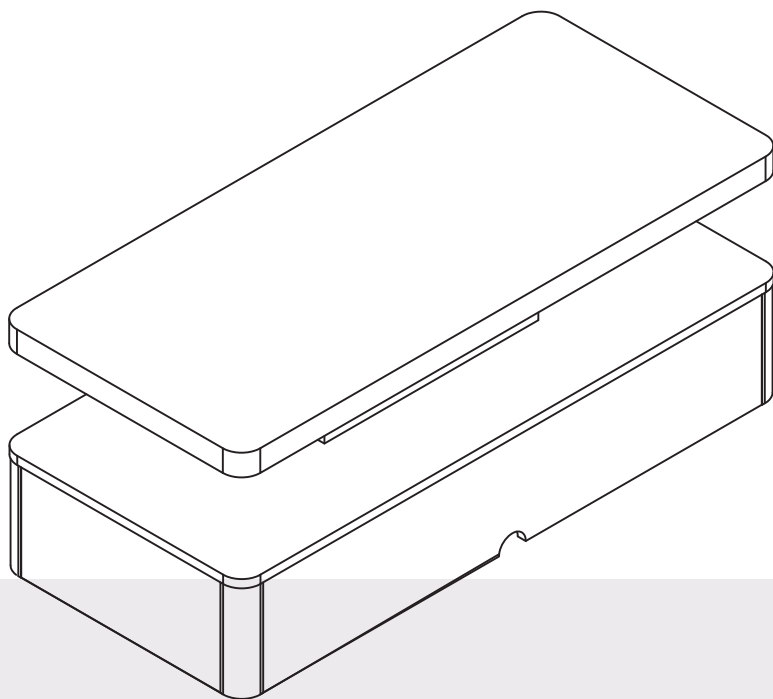

We offer a diverse range of products to meet the needs of customers.

## **Indoor Furniture**

---

We are a professional furniture provider with top-notch factories and outstanding designs, Our mission is to provide consumers with new lifestyles. By collecting consumer feedback, we constantly improve our products and create more choices for consumers. If you want to create your space, We are an ideal choice.

---

Always.

---



# WARNING

All the TV Stands have passed strict quality inspections before delivery . Read this manual carefully to ensure proper usage

---

Ensure that all parts and hardware are available before beginning assembly

## NOTICE

1. Children are not allowed to operate.
2. Faster installation is possible with power tools.
3. Do not pull the door vigorously to prevent the storage cabinet from tipping over.
4. Please attach the storage cabinet to the wall with an anti-tip device after installation is complete.
5. When using the storage cabinet for the first time, please keep it in a ventilated environment to allow the smell to fully evaporate.
6. When placing the partitions, please make sure the nails are firmly installed to prevent the partitions from falling off.
7. If any parts are missing, broken, damaged or worn, discontinue use of the product until repairs are made and/or factory replacement parts are installed.
8. Do not use this product in a manner inconsistent with the manufacturer's instructions, as this may void the product warranty.
9. If accessories are missing, please contact customer service for communication in time, we provide 7x24 hours customer care.
10. Do not use any attachments or accessories other than the original factory attachments and accessories.
11. Do not alter this equipment. Any alteration will create a safety hazard.

## WARNING

The product must be assembled by adult before use. Serious or fatal injury may occur from unexpected assembly or use.

1. During the assembly process, keep all parts away from babies or children.
2. Always securely fix this product to the wall. Make sure the wall area to be drilled is free from hidden electrical wires, water and gas pipes.
3. Use of tip-over restraints may only reduce, but not eliminate the risk of tip-over.
4. Unless specially designed to accommodate, do not set heavy objects on top of this product.
5. Place the heaviest items on the lowest shelf.
6. Never allow children to climb or bang on drawers, doors or shelves.

# HARDWARE

1

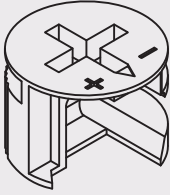

56 PCS

2

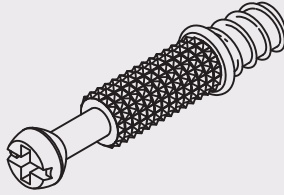

56 PCS

3

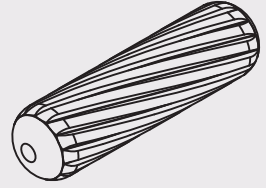

44 PCS

4

SCREW  $\phi$  6.3 x 50

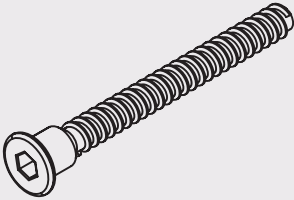

6 PCS

5

SCREW  $\phi$  3 x 14

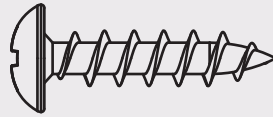

8 PCS

6



1 PC

7

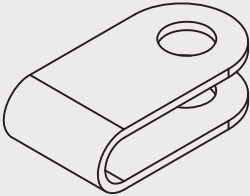

6 PCS

8



1 PC

9

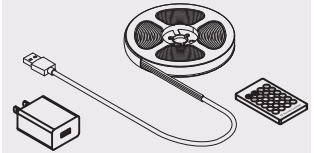

1 PC

# PARTS

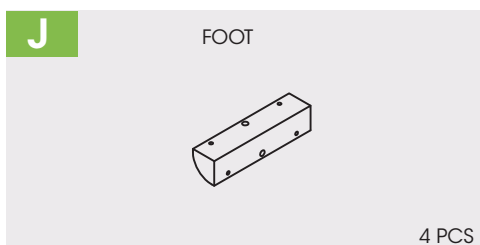
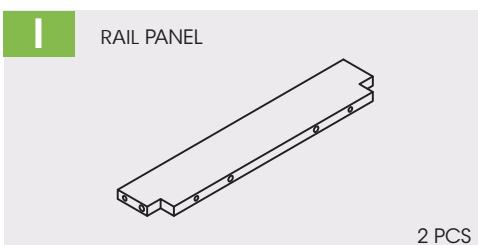
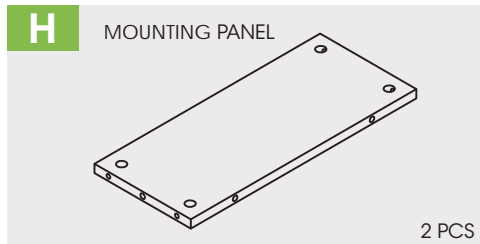
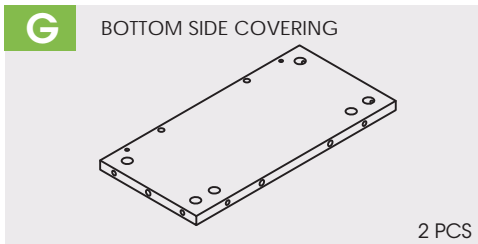
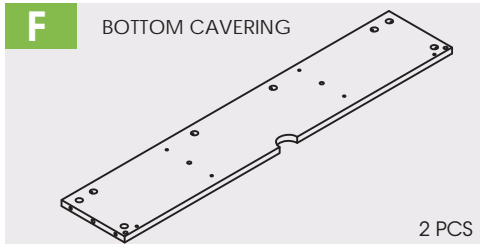
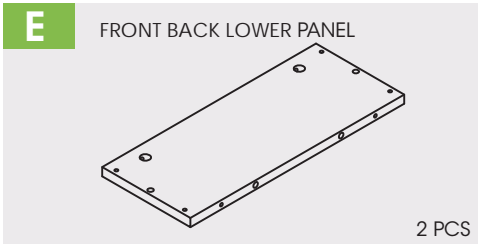
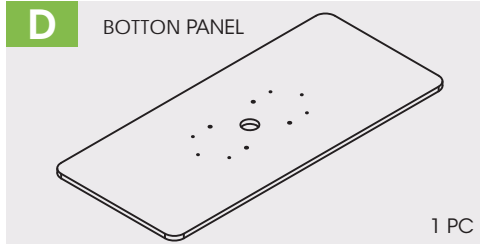
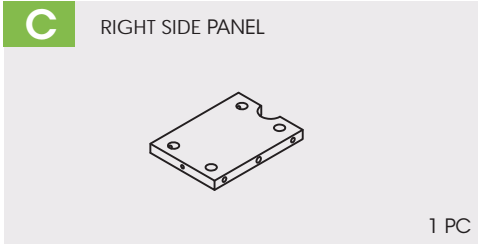
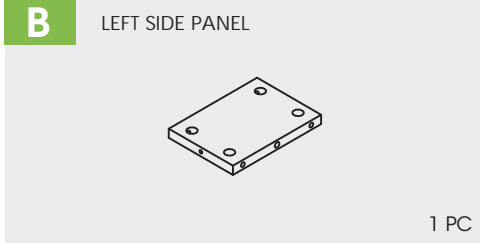
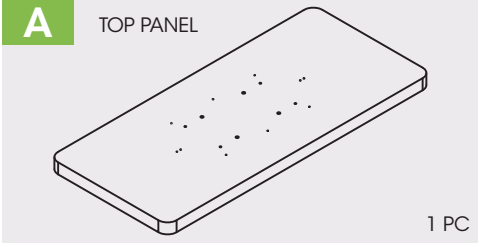

# I BOARD IDENTIFICATION

not show actual size

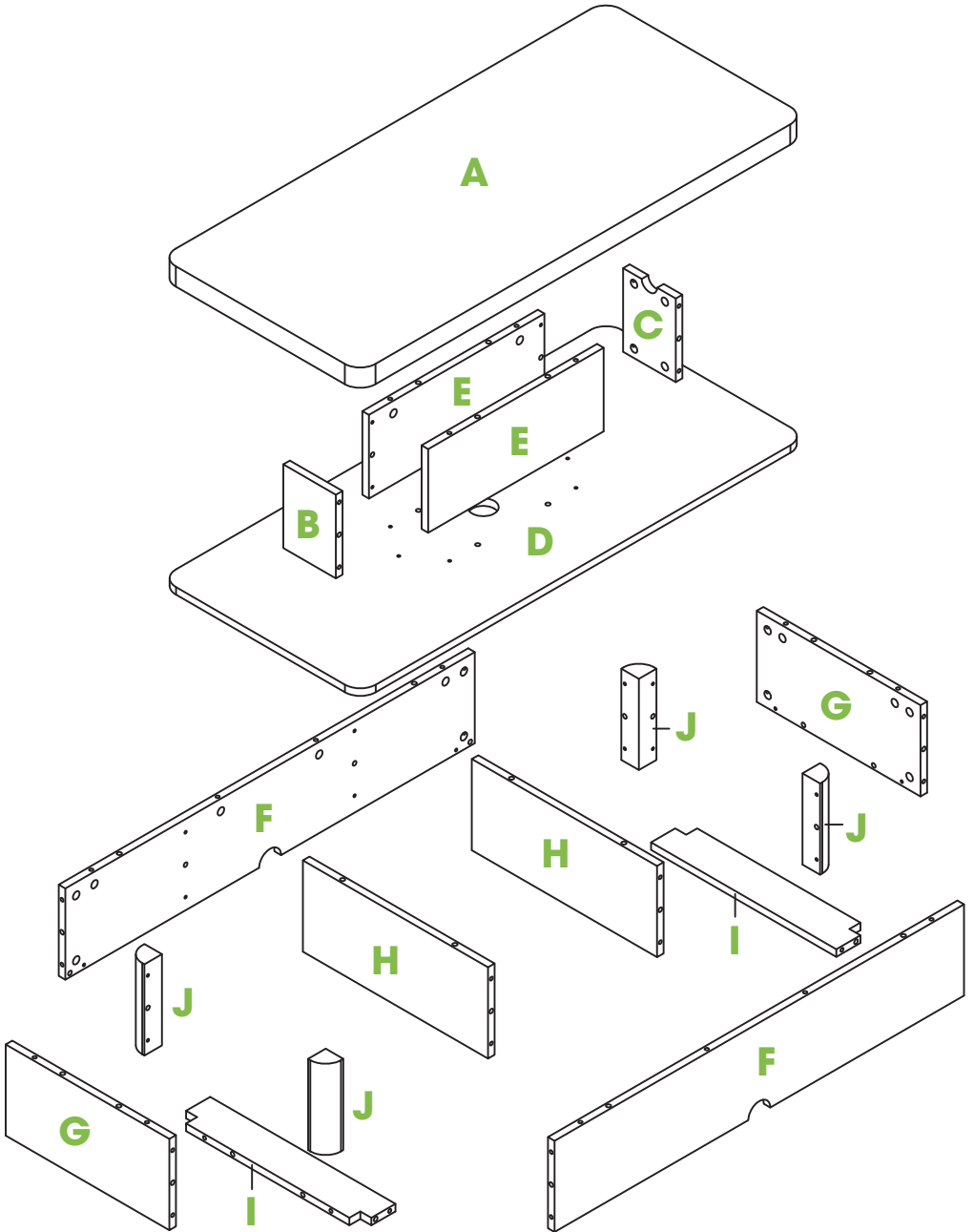

# PRODUCT ASSEMBLY

1

Install 24 cam bolt ② and 20 wooden bolt ③ on the corresponding holes of the part as per diagram.

PART	NO.	QTY.
	②	24
	③	20

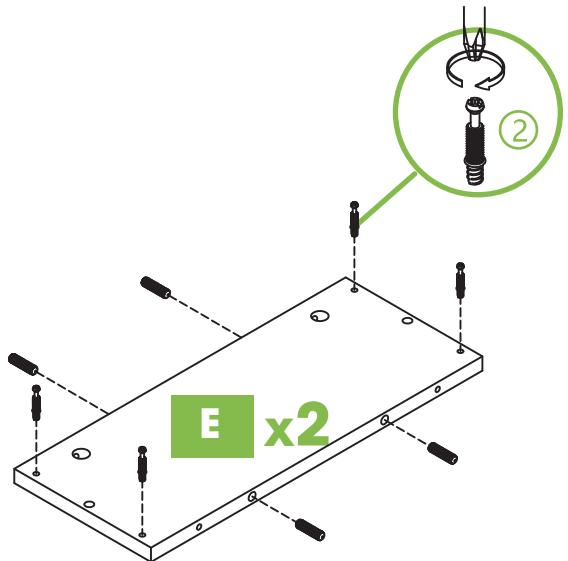
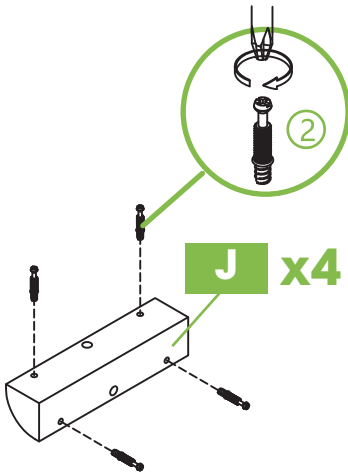
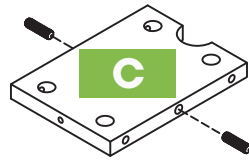
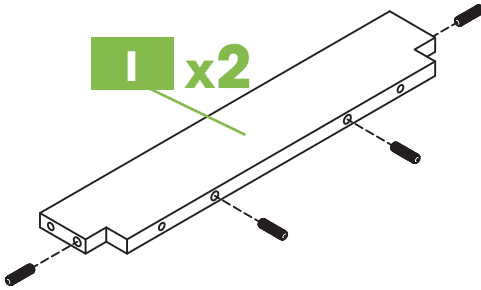
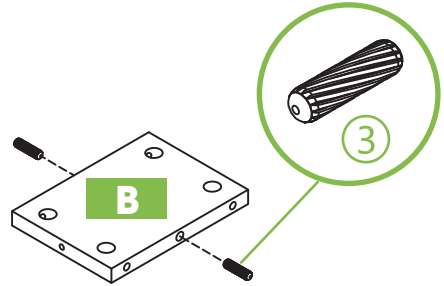

# PRODUCT ASSEMBLY

2

Install 4 cam bolt ② on the corresponding holes of the part as per diagram.

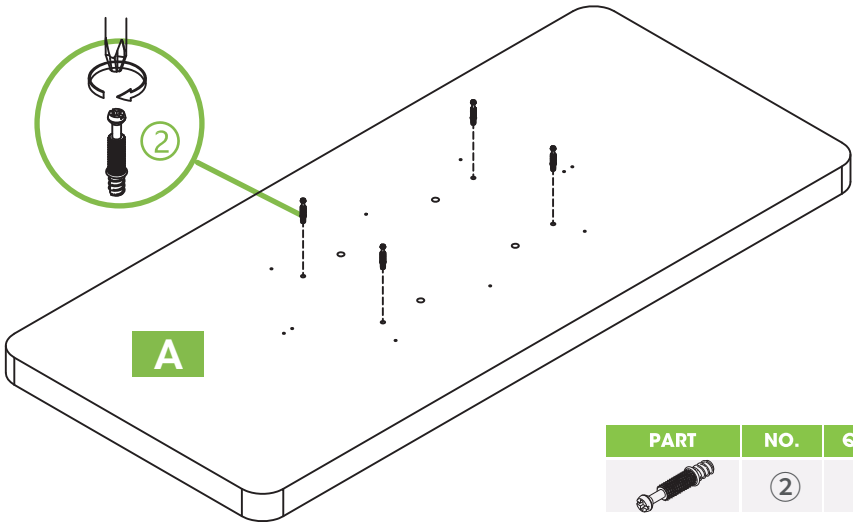

PART	NO.	QTY.
	②	4

3

Connect parts B, C and 2 part E with 8 bolt ①

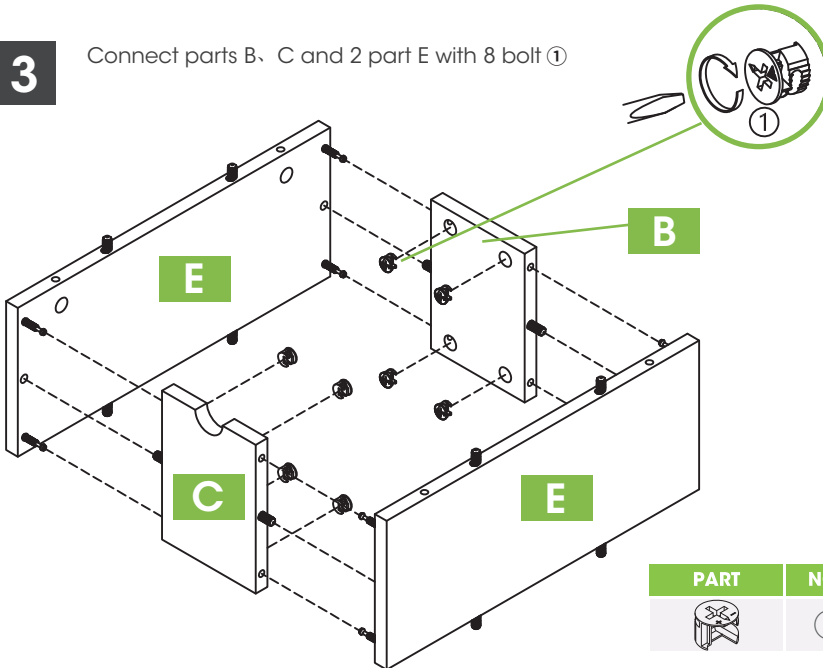

PART	NO.	QTY.
	①	8

# PRODUCT ASSEMBLY

4

Connect the parts with 4 bolt ① as per diagram.



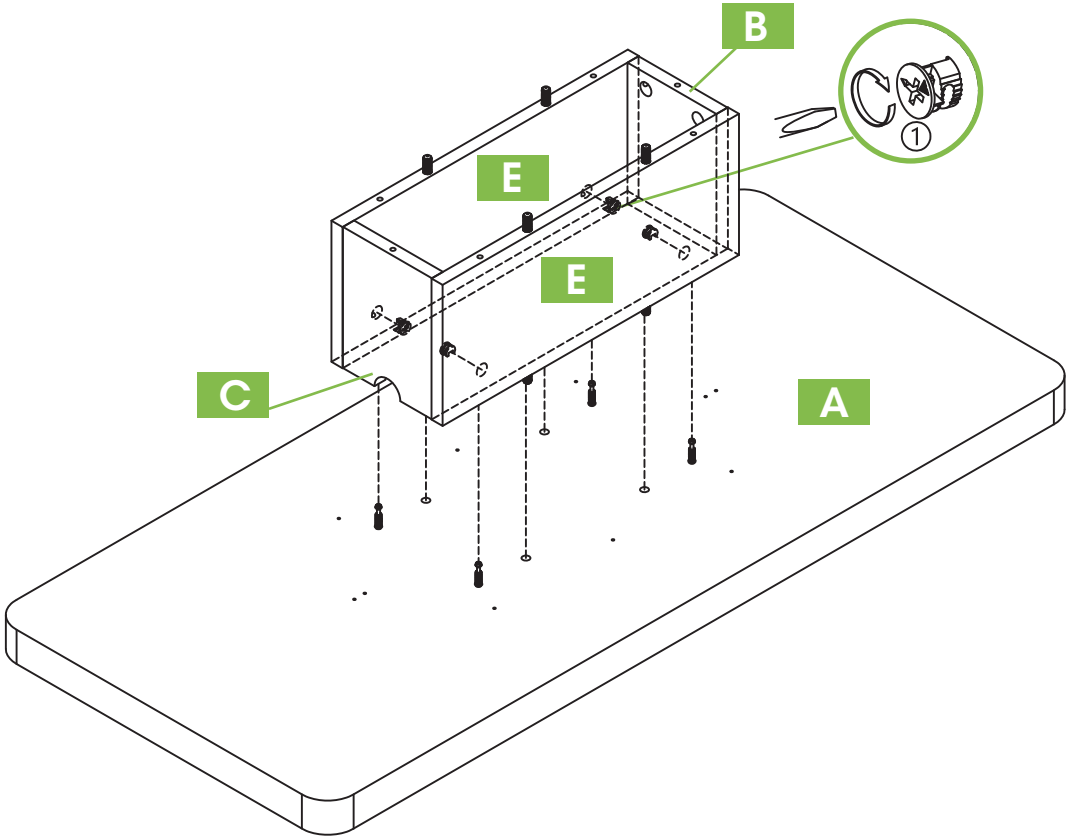

PART	NO.	QTY.
	①	4

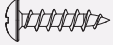

# PRODUCT ASSEMBLY

**5**

Install the light belt, jam the light belt with part ⑥ and ⑦ and secure with screw ⑤ Turn the screw clockwise

PART	NO.	QTY.
	⑤	8
	⑥	1
	⑦	6
	⑨	1

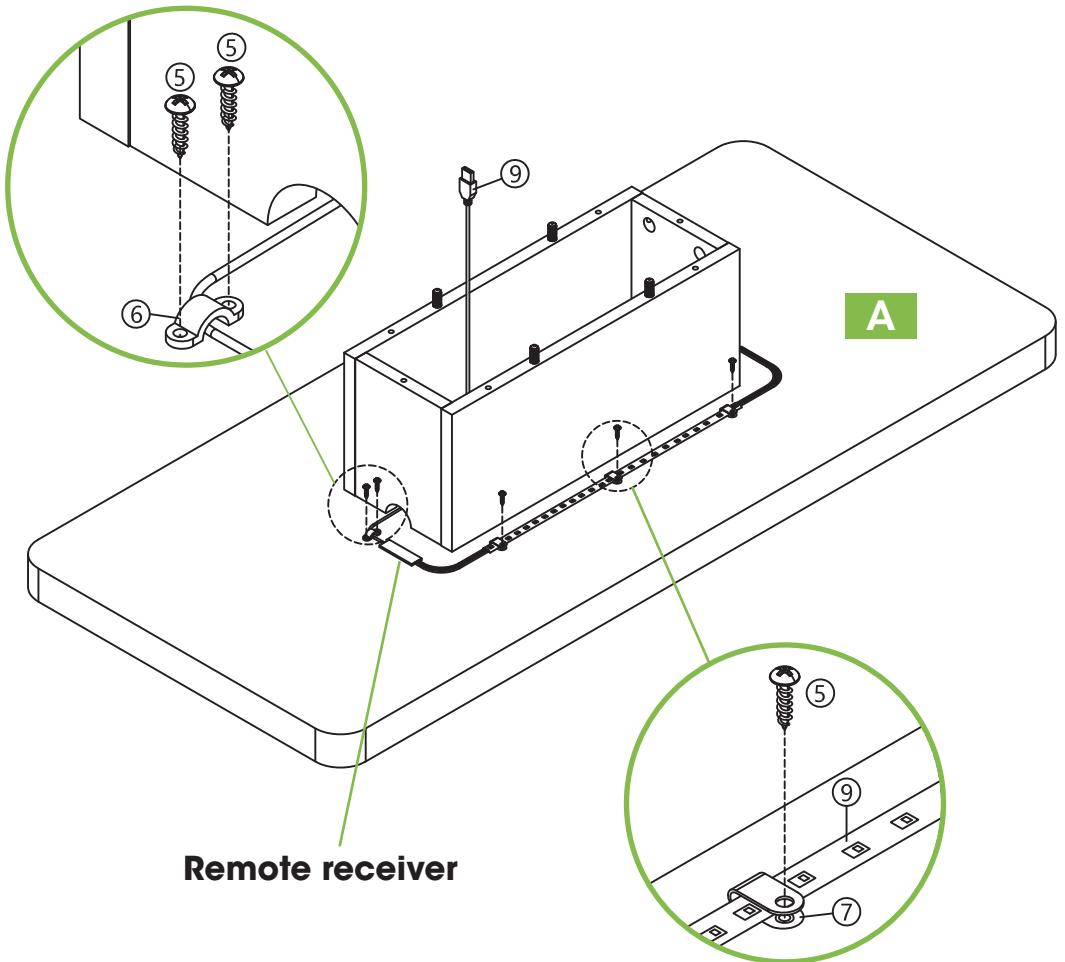

# PRODUCT ASSEMBLY

6

Install 12 cam bolt ② on the corresponding holes of the part as per diagram.

PART	NO.	QTY.
	②	12

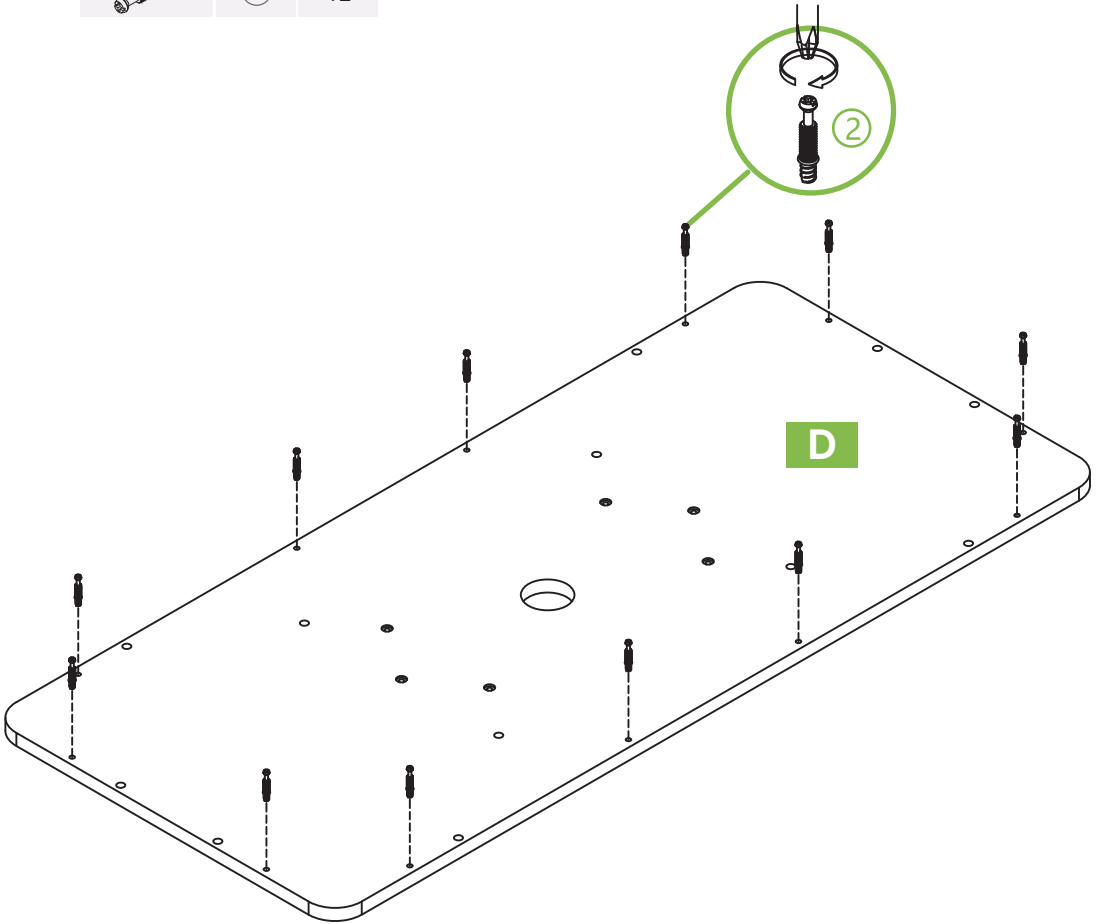

# PRODUCT ASSEMBLY

7

Connect D with 6 screws ④

PART	NO.	QTY.
	④	6
	⑧	1

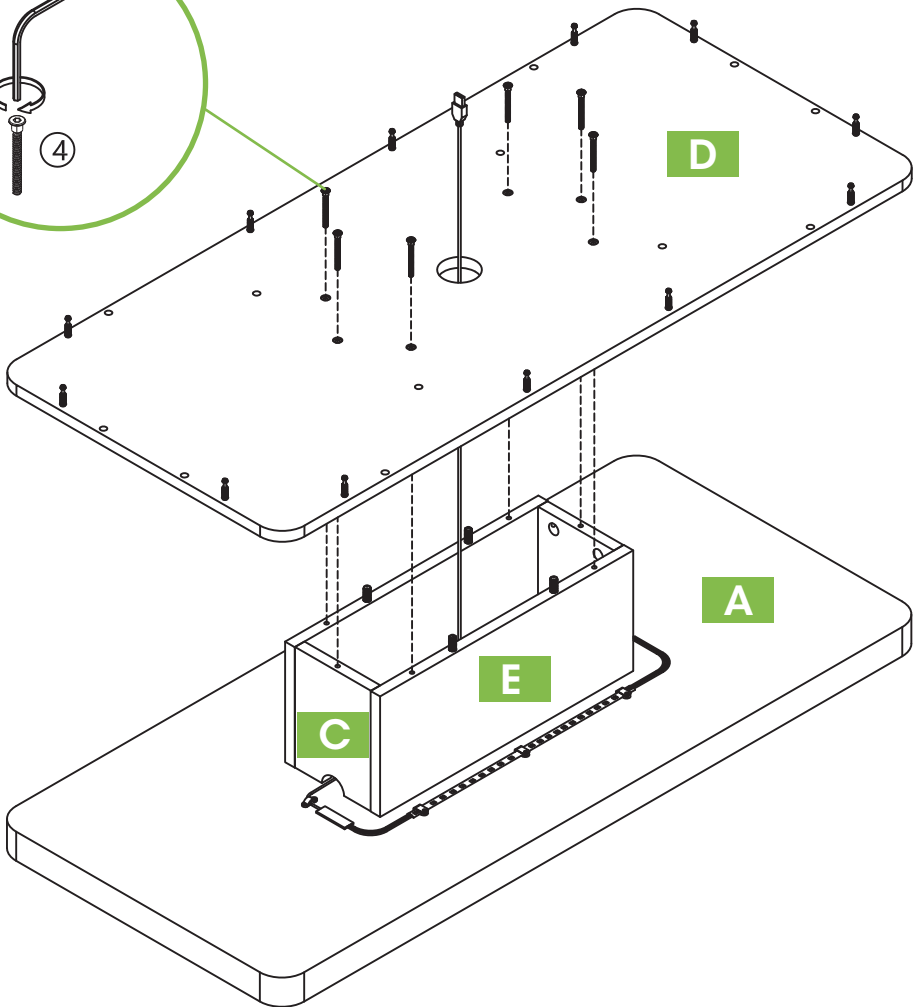
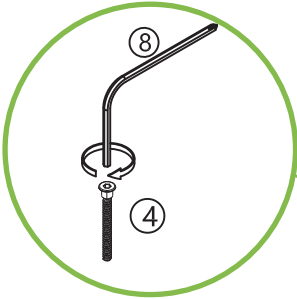

# PRODUCT ASSEMBLY

8

Install 16cam bolt ② and 24 wooden bolt ③ on the corresponding holes of the part as per diagram.

PART	NO.	QTY.
	②	16
	③	24

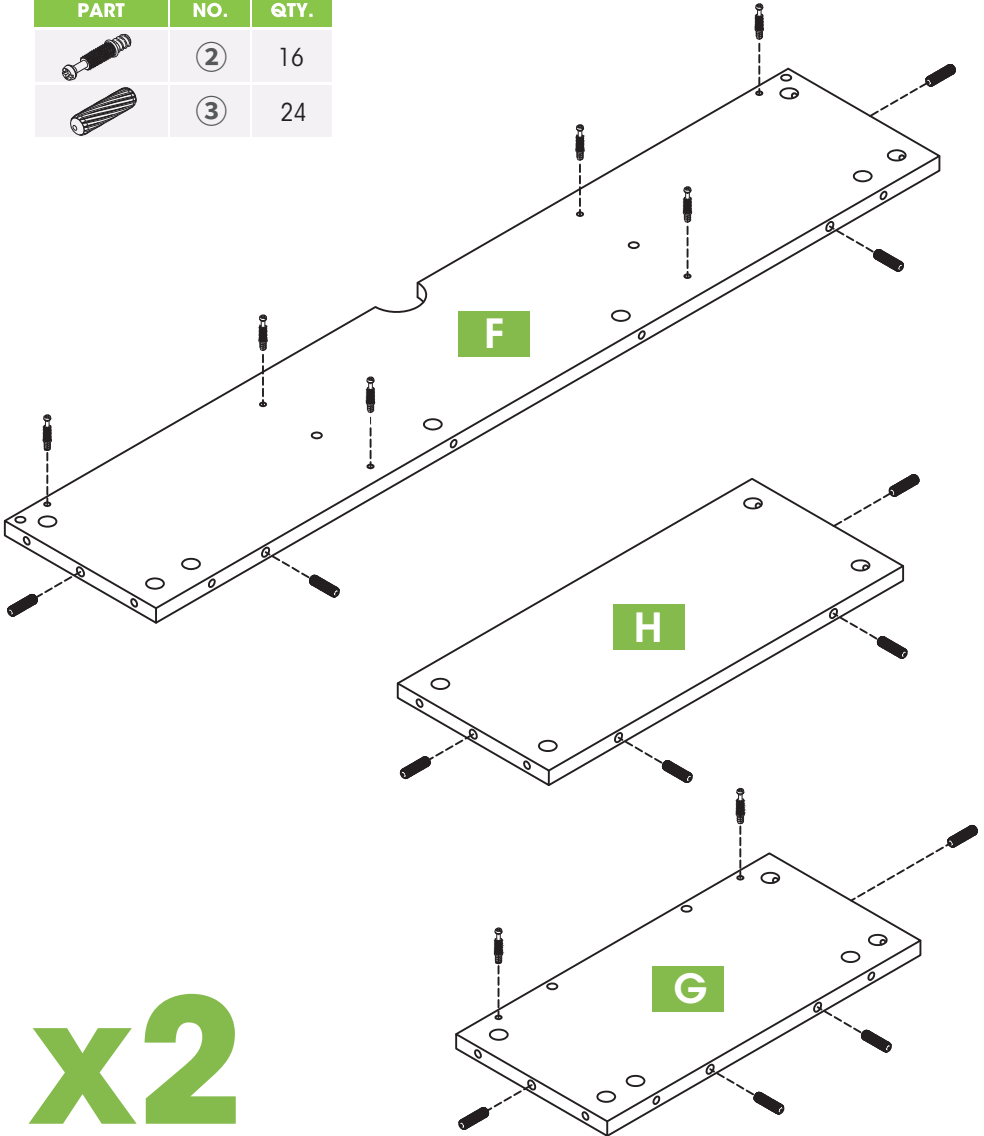

# PRODUCT ASSEMBLY

9

Connect the parts with 12 bolt ① as per diagram.

PART	NO.	QTY.
	①	12

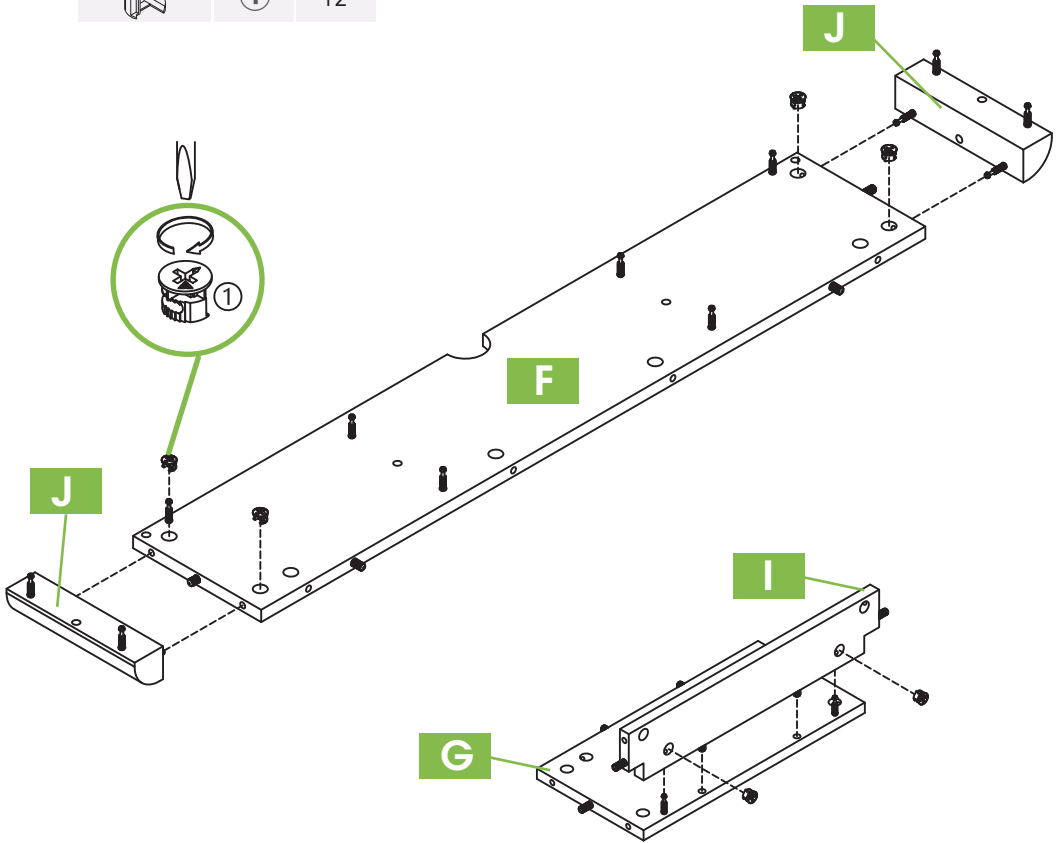

x2

# PRODUCT ASSEMBLY

## 10

Connect the parts with 20 bolt ① as per diagram.

PART	NO.	QTY.
	①	20

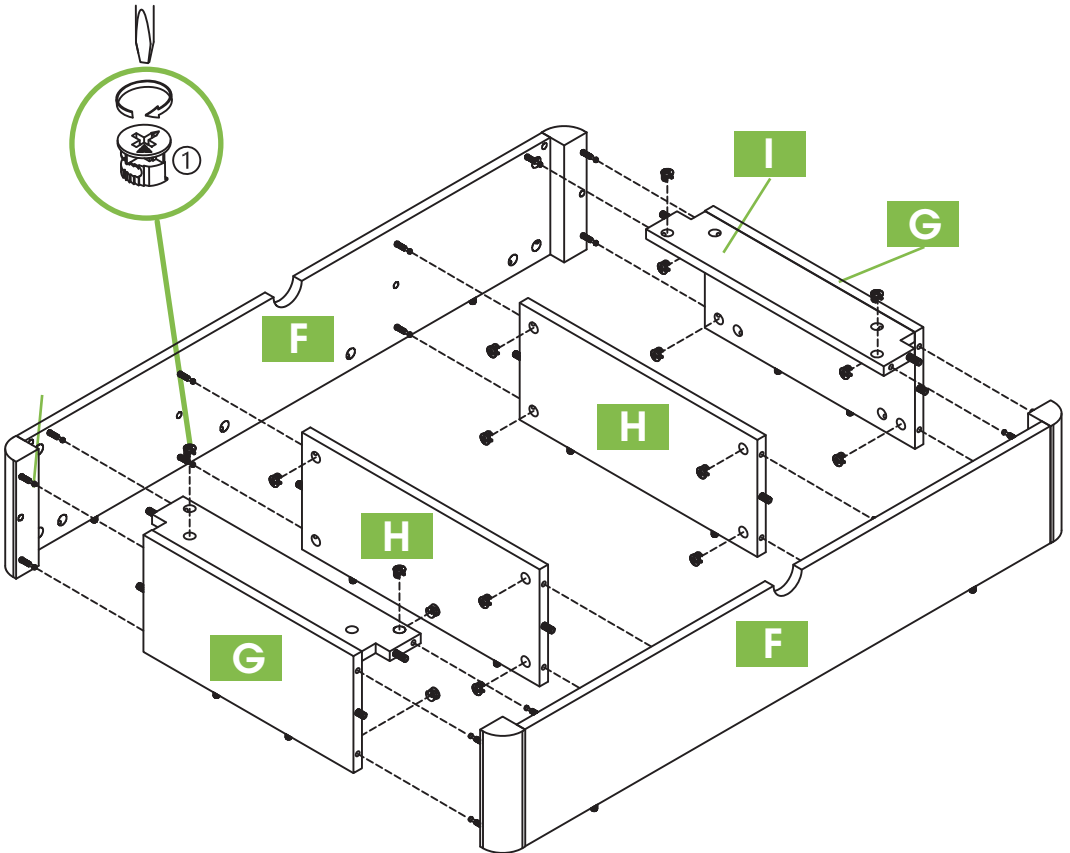

# PRODUCT ASSEMBLY

11

Connect the parts with 20 bolt ① as per diagram.

PART	NO.	QTY.
	①	12

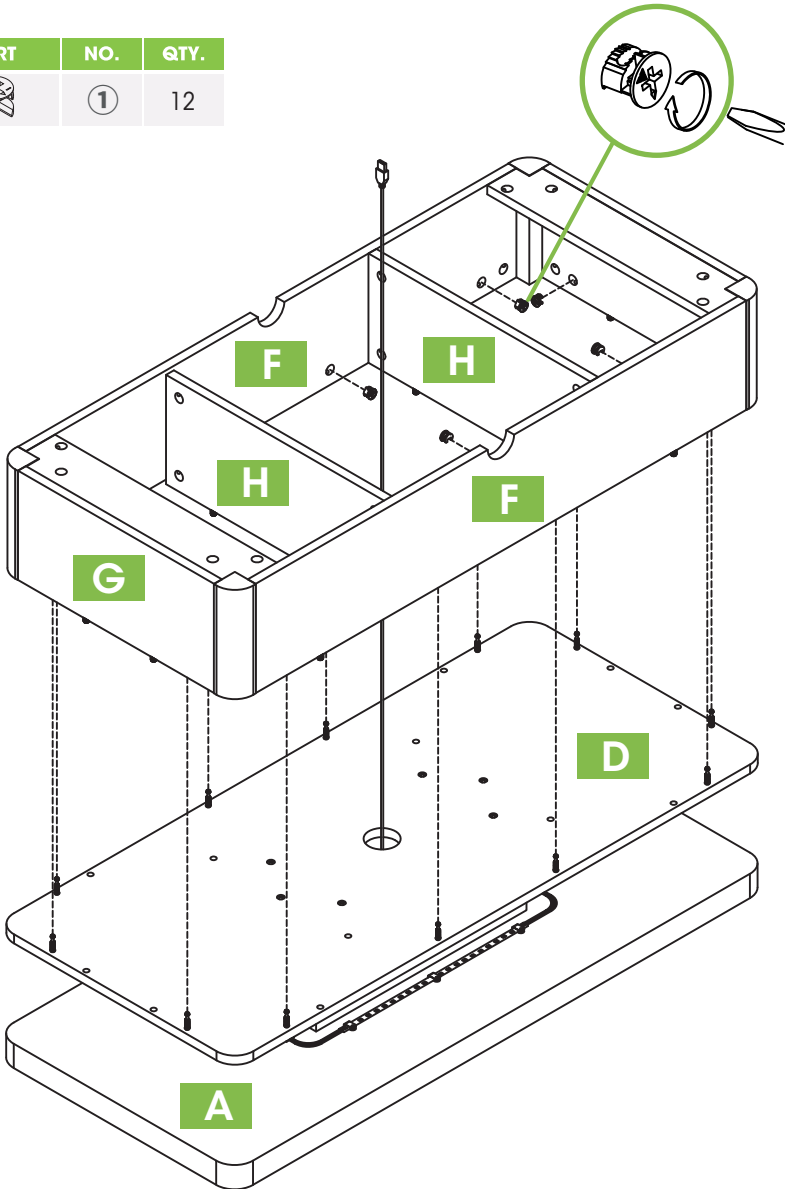

# PRODUCT ASSEMBLY

PART	NO.	QTY.
	9	1

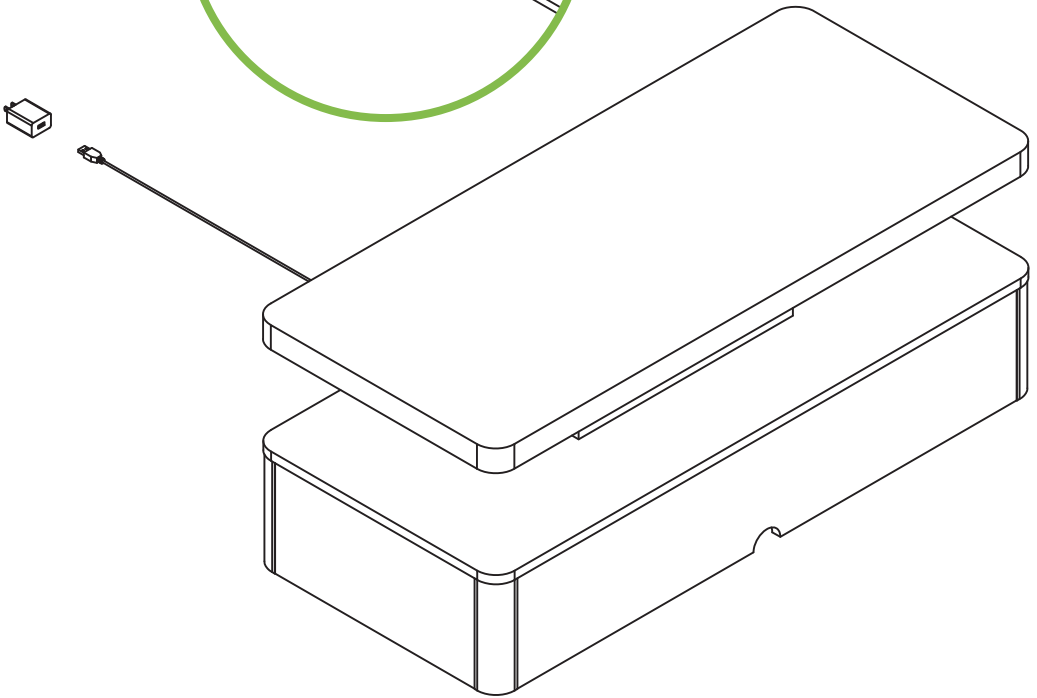
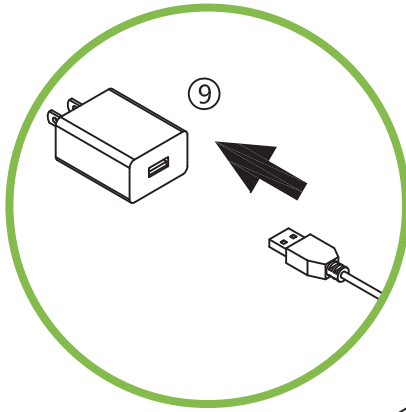

# RGB LED Light strip

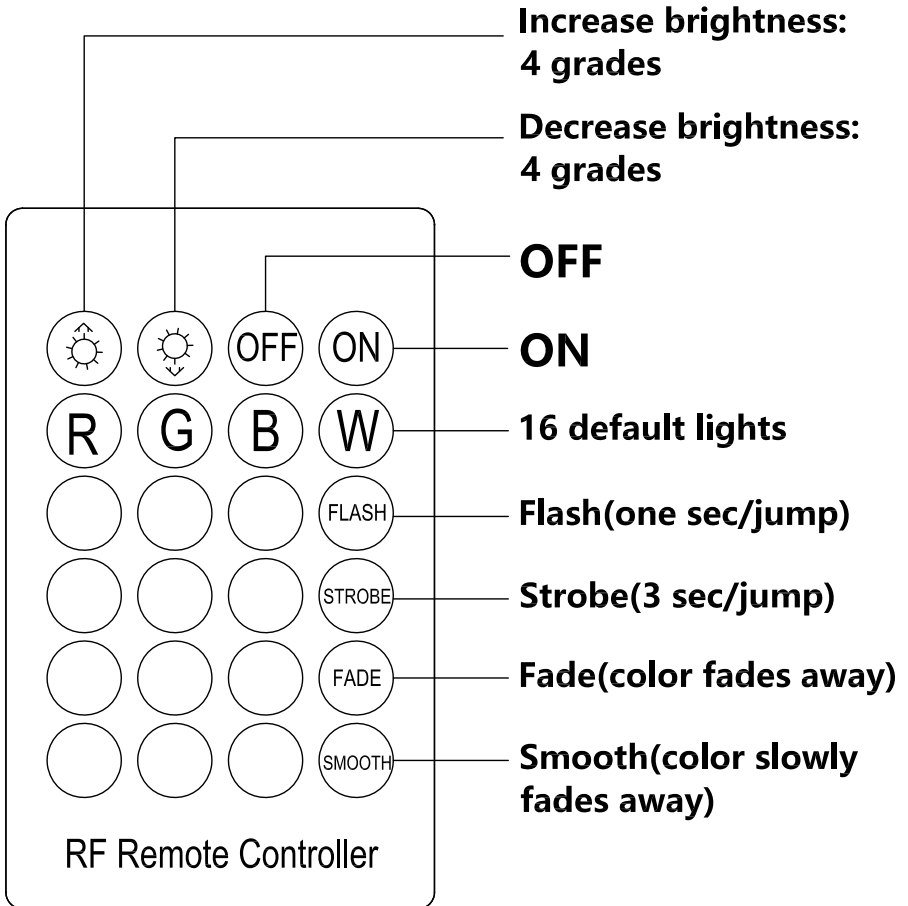

## **We Stand Behind the Quality of Their Furniture**

If you have any issues with your item please let us know! We will always do our best to come up with a solution that you will be happy with.

Please get in touch with our customer service team before returning the product.

And pls do not throw the original box(es) if you have not finished assembling or confirmed no quality issues.

Length of return period:

Items can be returned within 30 days of purchase.

In the meanwhile, everything you purchased from us comes with a one-year warranty.

Who is responsible for the return shipping fee:

We will cover the return shipping fees if: