

WARNING!!

Children have died from furniture tipover. Tip restraints have been included with this product; you must install the tip restraints according to these instructions in order to minimize the risk of furniture tipping.

NEVER allow children to climb or hang on furniture, including drawers or cabinet doors.

In addition to installing the restrains, to help prevent tip-over











1. NEVER put a TV or other heavy objects on top of this product".
2. Do not stand on the product

| ⚠ WARNING | |
|---|--|
|  | <p>Children have died from furniture tipover. To reduce the risk of furniture tipover:</p> <ul style="list-style-type: none">-ALWAYS install anti-tip device provided.-NEVER put a TV on this product.-NEVER allow children to stand, climb, or hang on any drawers, doors, or shelves.-NEVER open more than one drawer at a time.-Place heaviest items in the lowest drawers. |
|  | <p><i>This is a permanent label. Do not remove!</i></p> |

Assembly Instructions

Caution : You must read this before you proceed

Care & Maintenance

-  ● Not for commercial use. For residential use only.
 -  ● Furniture may scratch floors. We recommend using furniture pads to protect your floors.
 -  ● Do not put hot items directly on furniture surface.
 -  ● Do not clean furniture with harsh cleansers or polish.
 -  ● Do not place furniture under direct sunlight.
 -  ● Do not place furniture near heating or cooling vents.
 -  ● Do not write on furniture without a padded barrier to protect the surface.
 -  ● Do not place furniture outside . For indoor use only.
 -  ● Stains may be removed with mild soap solution and damp cloth.
 -  ● Children should not climb or jump on the furniture.
-
-  ● Dust and pick-up spills using a clean, non-colored, lint-free cloth.

Please look in carton for hardware packs and legs.



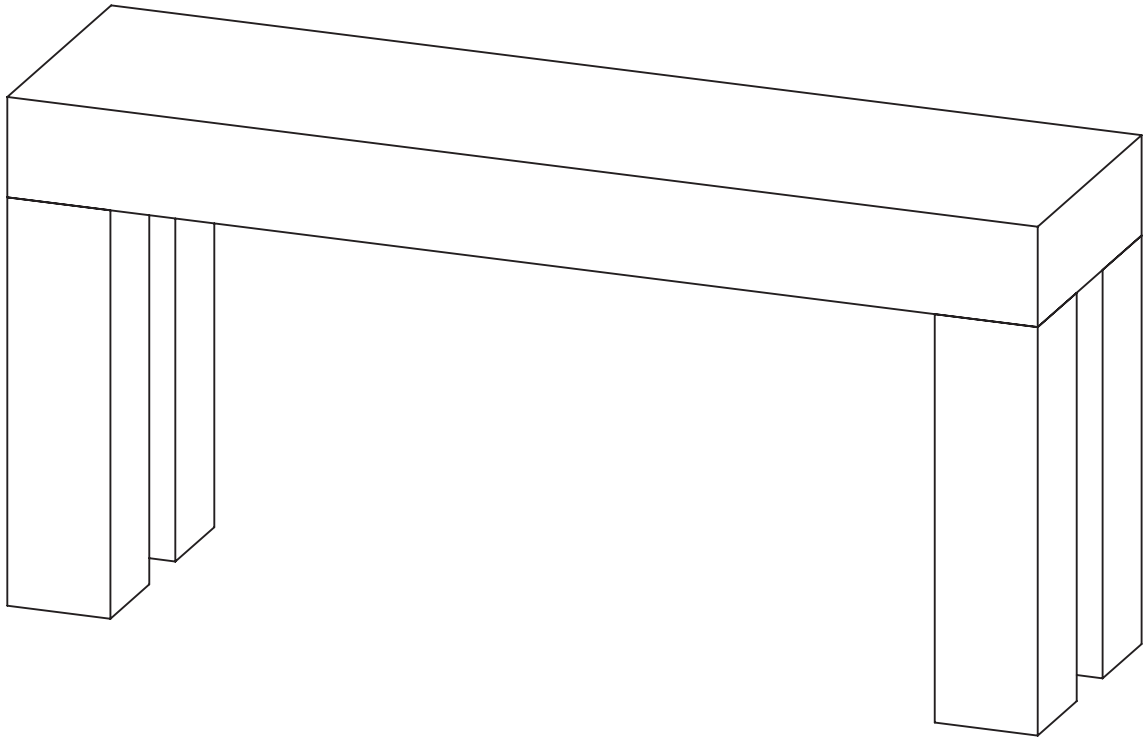

Console Table

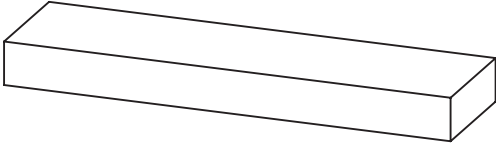
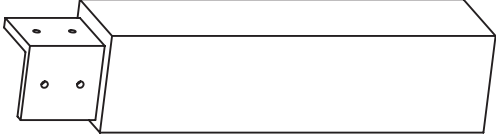

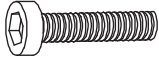

Parts List

| Label | Picture | Description | QTY |
|-------|---|-------------|-----|
| A |  | Top Panel | 1 |
| B |  | Leg | 4 |

Hardware

| Label | Picture | Description | QTY |
|-------|---|-----------------------|------|
| ① |  | Bolt (M8*30mm) | 16+1 |
| ② |  | Flat Washer | 16+1 |
| ③ |  | Spring Washer | 16+1 |
| ④ |  | L-type Hexagon Wrench | 1 |

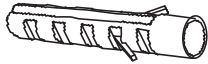
Restraint Device Hardware

| | | | |
|---|---|-------------------------|---|
| ⑤ |  | Anti-Tipping Iron Sheet | 2 |
| ⑥ |  | Nut | 2 |
| ⑦ |  | Screw Ø4*14mm | 2 |
| ⑧ |  | Screw Ø4*35mm | 2 |

Assembly Preparation

Before
Beginning
Assembly:

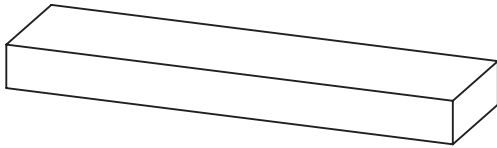

Ax1

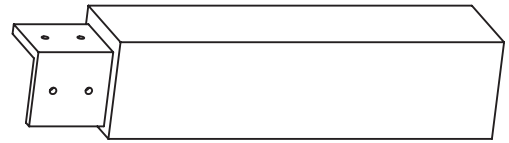

Bx4

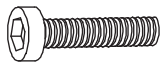

① x17



② x17



③ x17



④ x1



⑤ x2



⑥ x2



⑦ x2



⑧ x2



- Read instructions, cover to cover-



- Have 2 adults on hand for assembly-



- Do not assemble on flooring or carpet-



- Assemble on a clean non-marring surface (packing foam)-



- Save all packaging until finished-

Assembly Steps

Overview

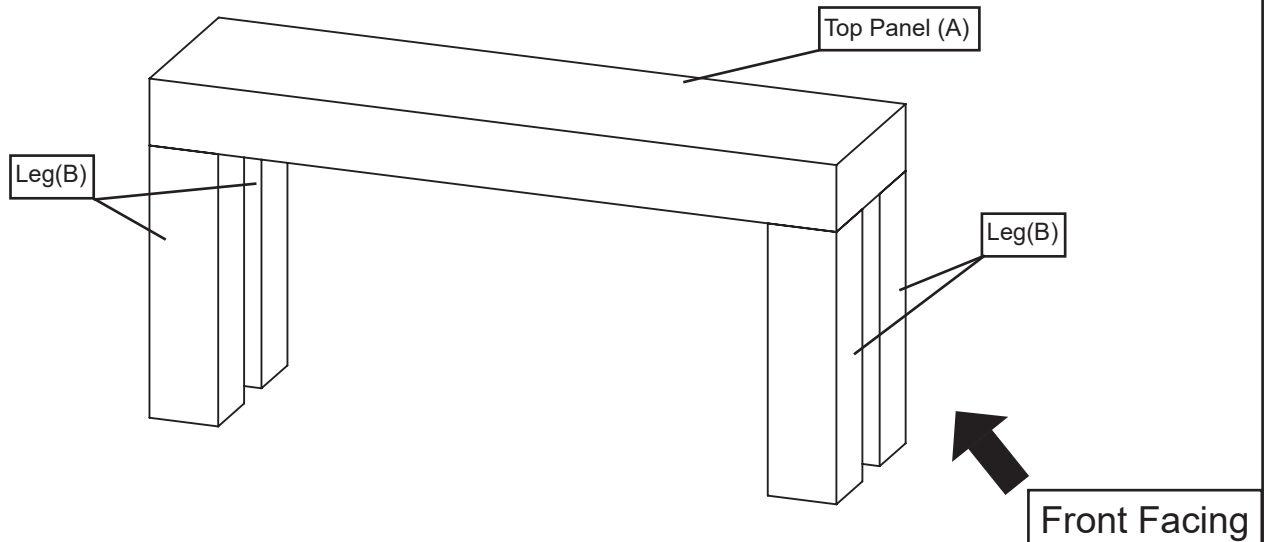

This Console Table has multiple parts and may require up to 30 minutes to assemble. To give you an overview of the Console Table parts, the above picture is to help you put the various parts into perspective. Please read through the instructions below to familiarise yourself with the parts and steps before assembly.

Step 1

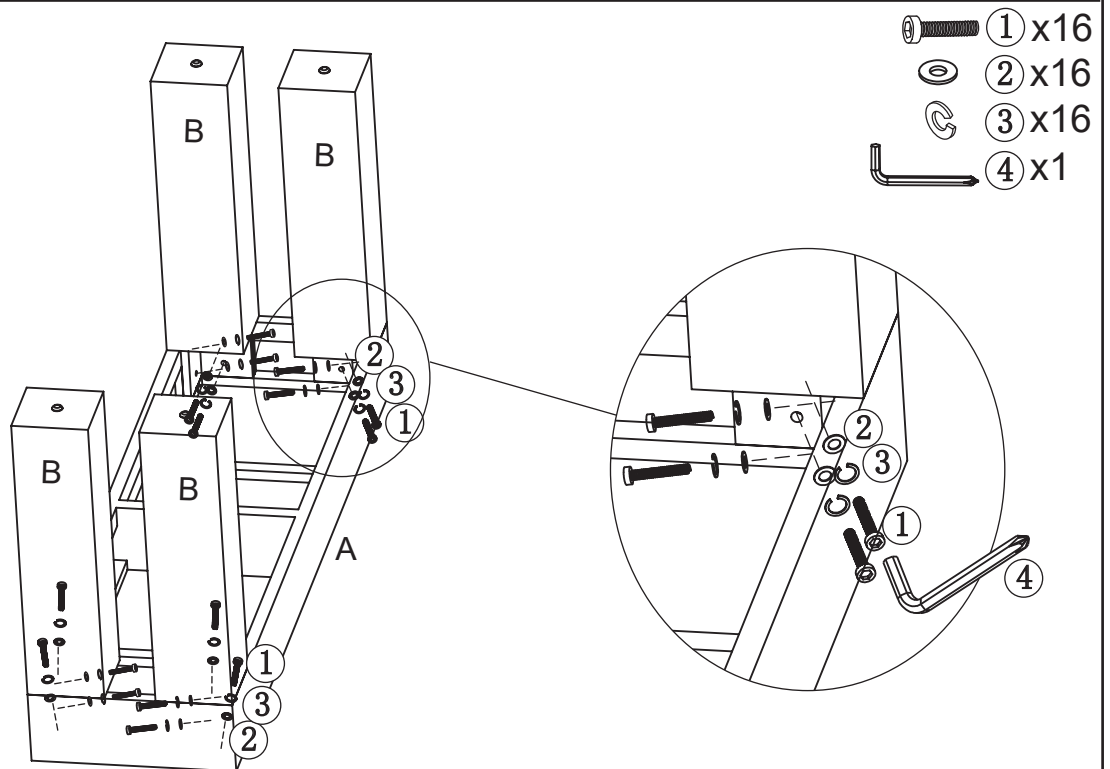

Attach the leg (B) to the top panel(A) with bolt(①),spring washer (③) and flat washer(②) using I-type hexagon wrench(④).

Step 2

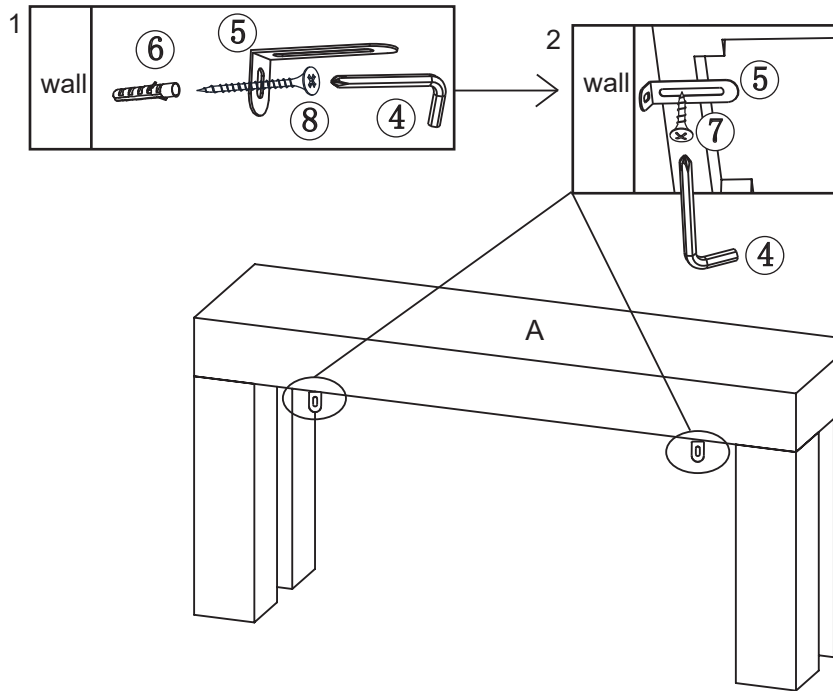

- ⑤ x2
- ⑥ x2
- ⑦ x2
- ⑧ x2
- ④ x1

Screw the nut (⑥) into the wall. Install the short side of anti-tipping sheet iron (⑤) on the wall with screw(⑧) using I-type hexagon wrench (④),then attach the long side of anti-tipping sheet iron (⑤) connected to the top panel(A) with screw(⑦) using I-type hexagon wrench (④).

Step 3

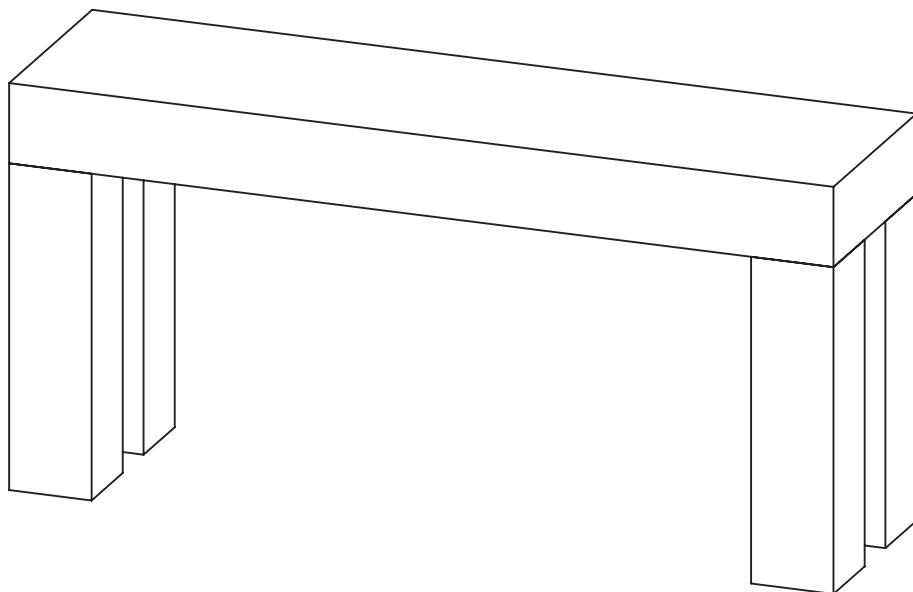

Note:If the assembled product is uneven, this can be resolved by adjusting the feet.

You table is ready for use.