

# ASSEMBLY INSTRUCTIONS

## INSTRUCTIONS DE MONTAGE

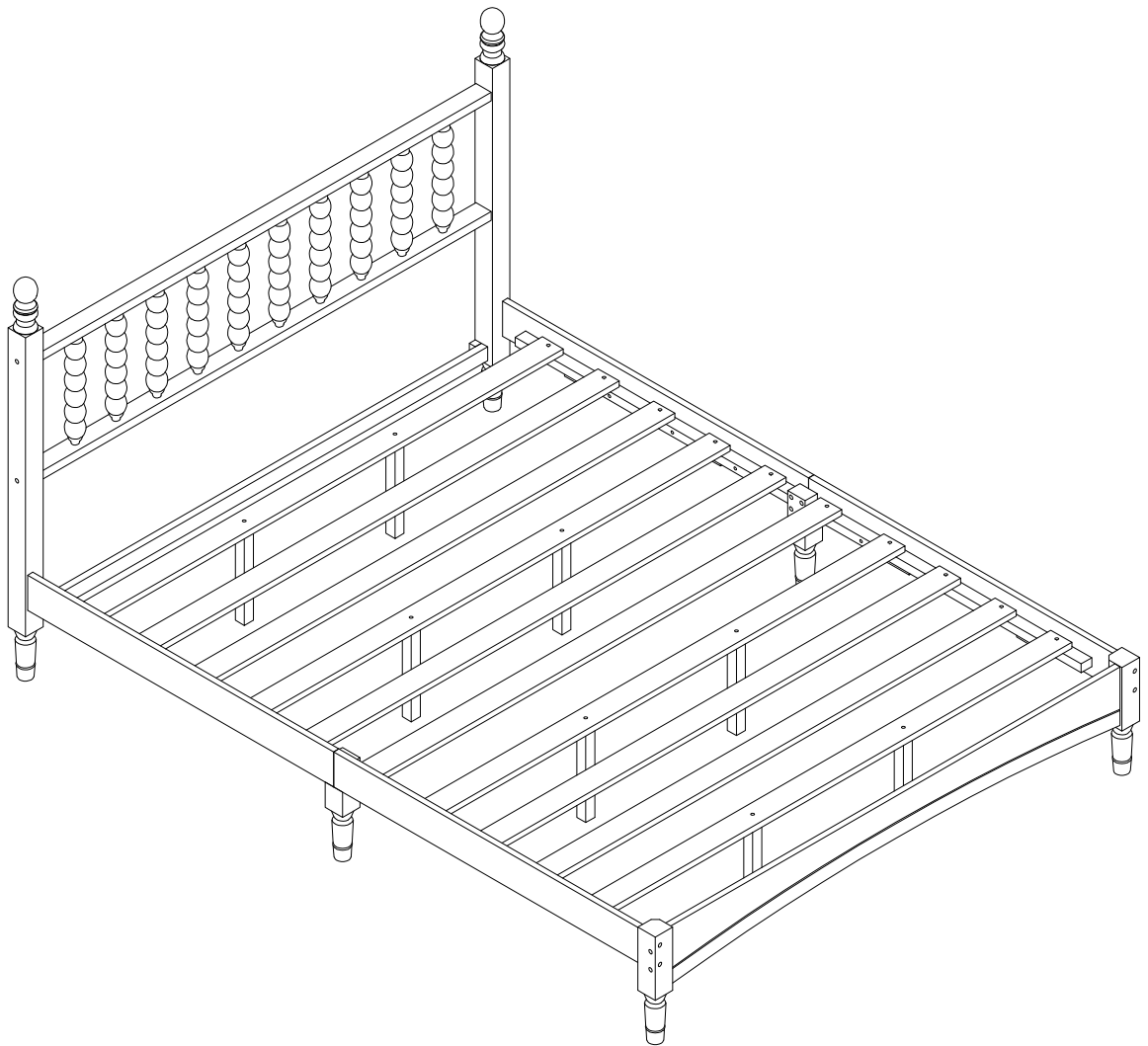





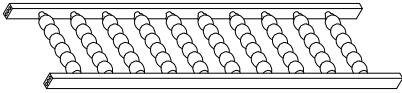
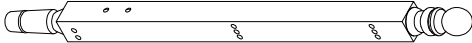
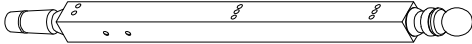

### QUEEN BED

### LIT DE REINE

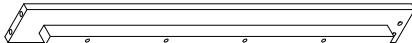

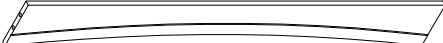
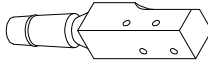
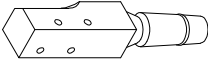
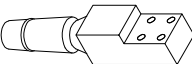







**Part List**  
Liste des pièces

<p>① x 1 PC</p>  <p><b>Frame Headboard</b> Tête de lit à cadre</p>	<p>② x 1 PC</p>  <p><b>Left Headboard Leg</b> Pied de tête de lit gauche</p>
<p>③ x 1 PC</p>  <p><b>Right Headboard Leg</b> Pied de tête de lit droit</p>	<p>④ x 2 PCS</p>  <p><b>SideRail</b> Rail latéral</p>
<p>⑤ x 2 PCS</p>  <p><b>SideRail</b> Rail latéral</p>	<p>⑥ x 1 PC</p>  <p><b>Support Headboard</b> Tête de lit avec support</p>
<p>⑦ x 1 PC</p>  <p><b>Panel Footboard</b> Pied de lit à panneau</p>	<p>⑧ x 1 PC</p>  <p><b>Right Footboard Leg</b> Pied de lit gauche</p>
<p>⑨ x 1 PC</p>  <p><b>Left Footboard Leg</b> Pied de lit droit</p>	<p>⑩ x 2 PCS</p>  <p><b>SideRail Leg</b> Pied de rail latéral</p>
<p>⑪ x 4 PCS</p>  <p><b>Slats</b> Lattes</p>	<p>⑫ x 8 PCS</p>  <p><b>Support Leg</b> Jambe de soutien</p>
<p>⑬ x 6 PCS</p>  <p><b>Slats</b> Lattes</p>	

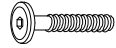
## Hardware List

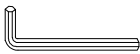
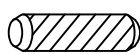
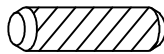
Liste des matériel

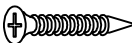

<p>Ⓐ x 16PCS</p>  <p>Ø1/4"x90mm</p> <p><b>Bolts</b> BouLon</p>	<p>Ⓑ x 8PCS</p>  <p>Ø1/4"x50mm</p> <p><b>Bolts</b> BouLon</p>	<p>Ⓒ x 2PCS</p>  <p>Ø1/4"x35mm</p> <p><b>Bolts</b> BouLon</p>
<p>Ⓓ x 26PCS</p>  <p>Ø1/4"x13mm</p> <p><b>Spring Washer</b> Rondelle elastique</p>	<p>Ⓔ x 26PCS</p>  <p>Ø1/4"x16mm</p> <p><b>Flat Washer</b> Rondelle plates</p>	<p>Ⓕ x 1PC</p>  <p>60*22*4mm</p> <p><b>Allen key</b> Clé Allen</p>
<p>Ⓖ x 2PCS</p>  <p>Ø8x30mm</p> <p>Wood dowel Cheville en bois</p>	<p>Ⓖ x 8PCS</p>  <p>Ø10x40mm</p> <p>Wood dowel Cheville en bois</p>	<p>Ⓖ x 12PCS</p>  <p>1/4"*15 (9.5mm)</p> <p>Horizontal-Hole bolts Boulons à tête hexagonale</p>
<p>Ⓙ x 20PCS</p>  <p>Ø4x25mm</p> <p>Wood screws Vis</p>		

### ASSEMBLY TOOLS REQUIRED ( NOT INCLUDED)

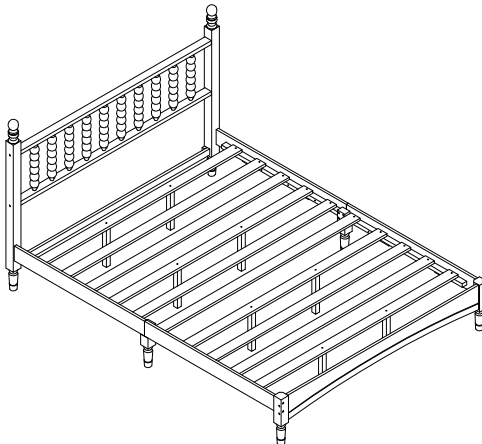
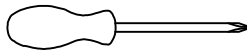
OUTILS D'ASSEMBLAGE REQUIS (NON INCLUS)



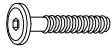

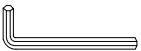
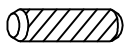
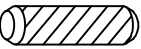

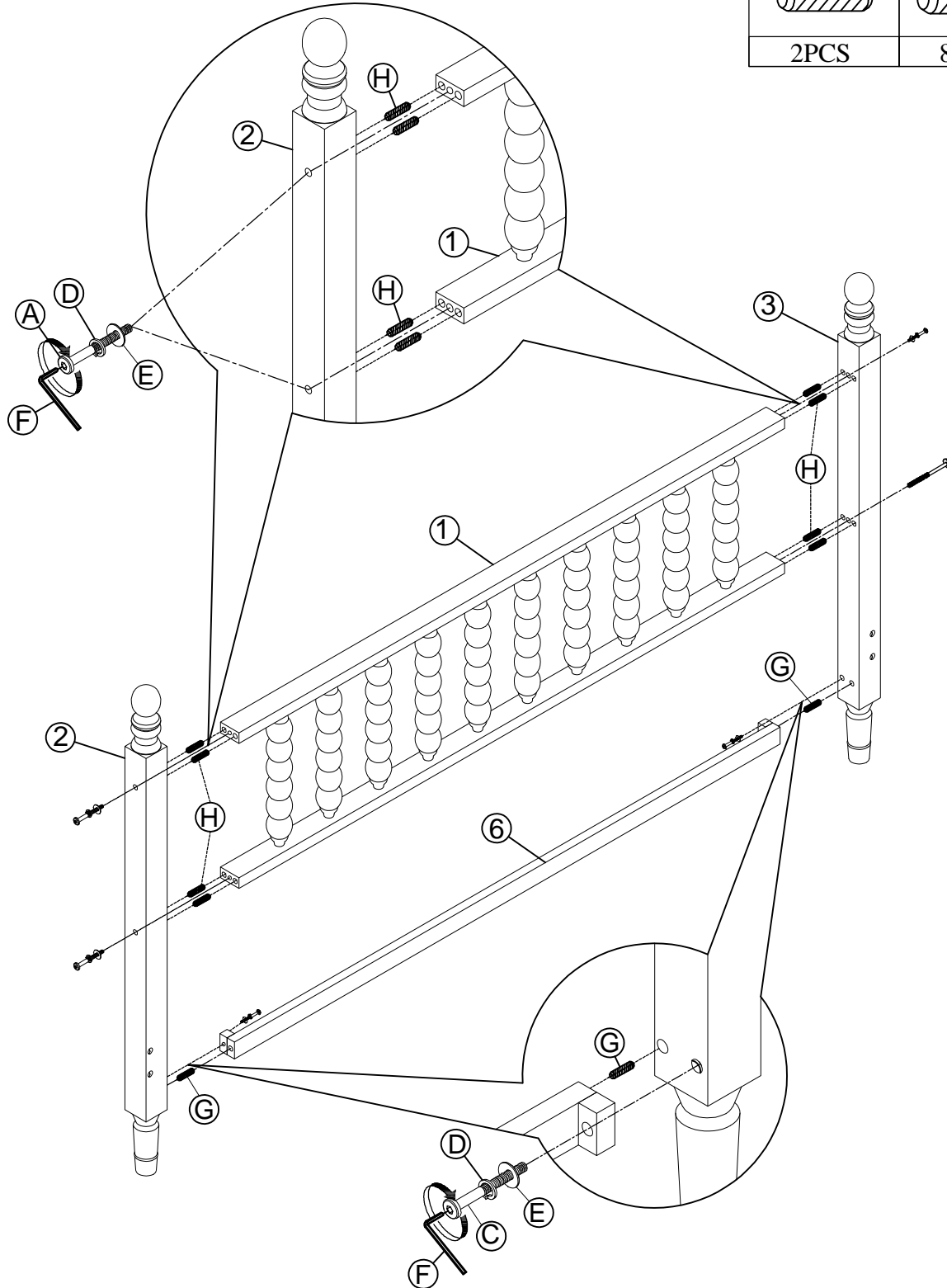
**STEP: 1**  
ÉTAPE

A 	C 	D 	E 	F 
4PCS	2PCS	6PCS	6PCS	1PC
			G 	H 
			2PCS	8PCS

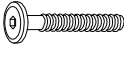

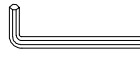

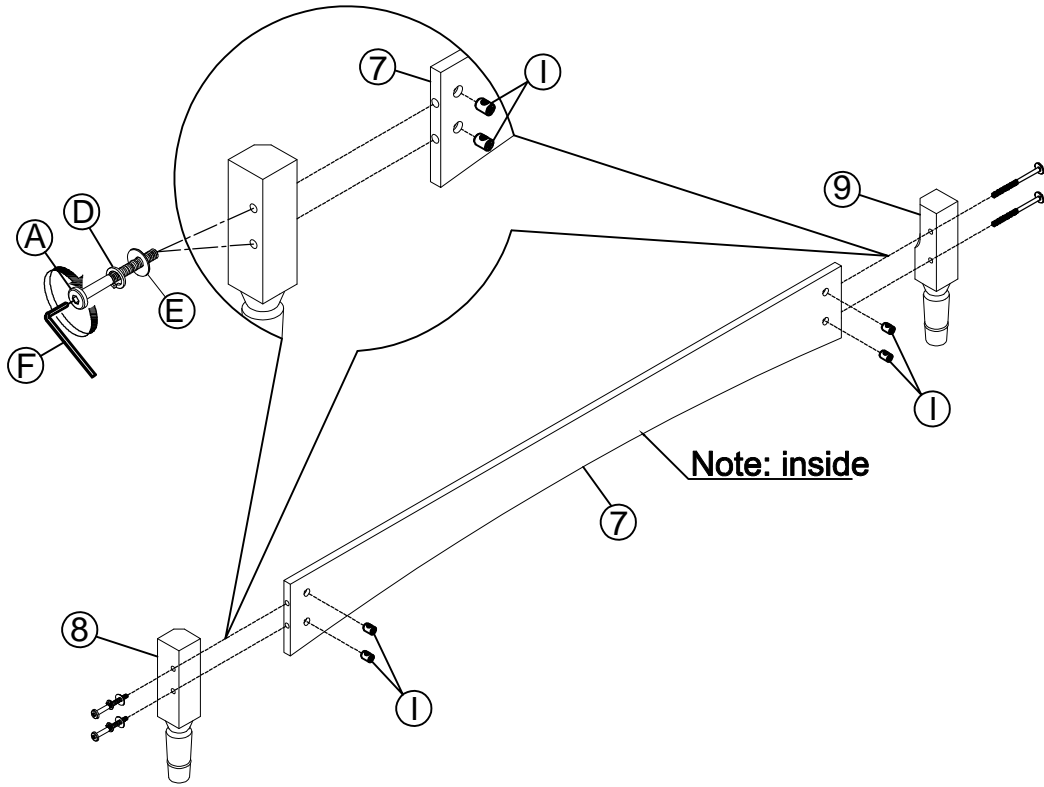

**STEP: 2**  
ÉTAPE

A	D	E	F	I
				
4PCS	4PCS	4PCS	1PC	4PCS





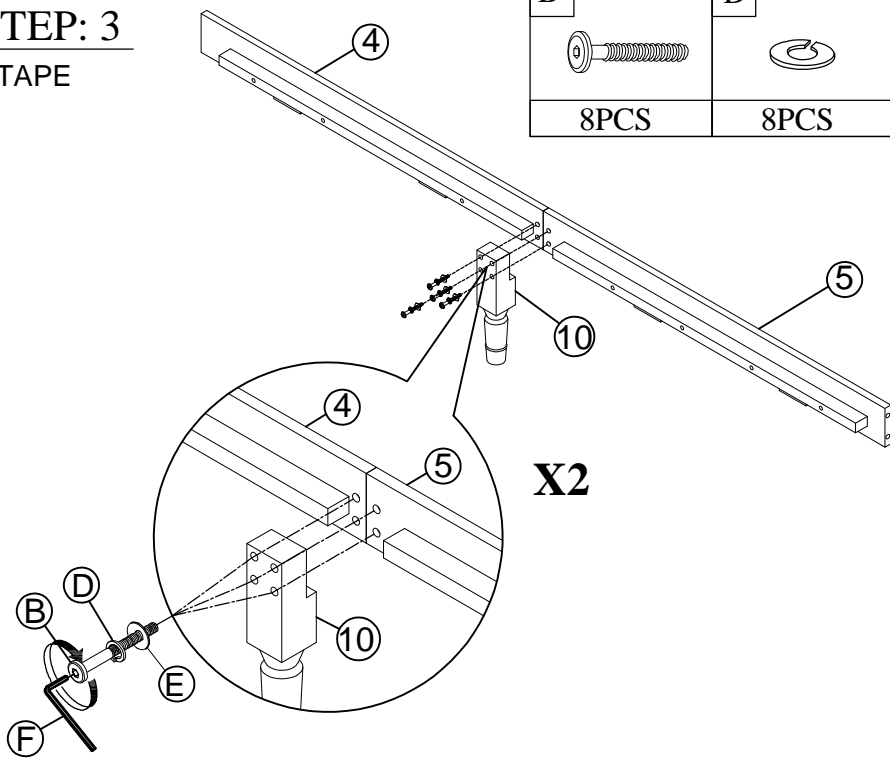

**STEP: 3**  
ÉTAPE

B	D	E	F
			
8PCS	8PCS	8PCS	1PC

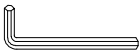

**STEP: 4**  
ÉTAPE

<p>A</p> 	<p>D</p> 	<p>E</p> 	<p>F</p> 	<p>I</p> 
<p>8PCS</p>	<p>8PCS</p>	<p>8PCS</p>	<p>1PC</p>	<p>8PCS</p>

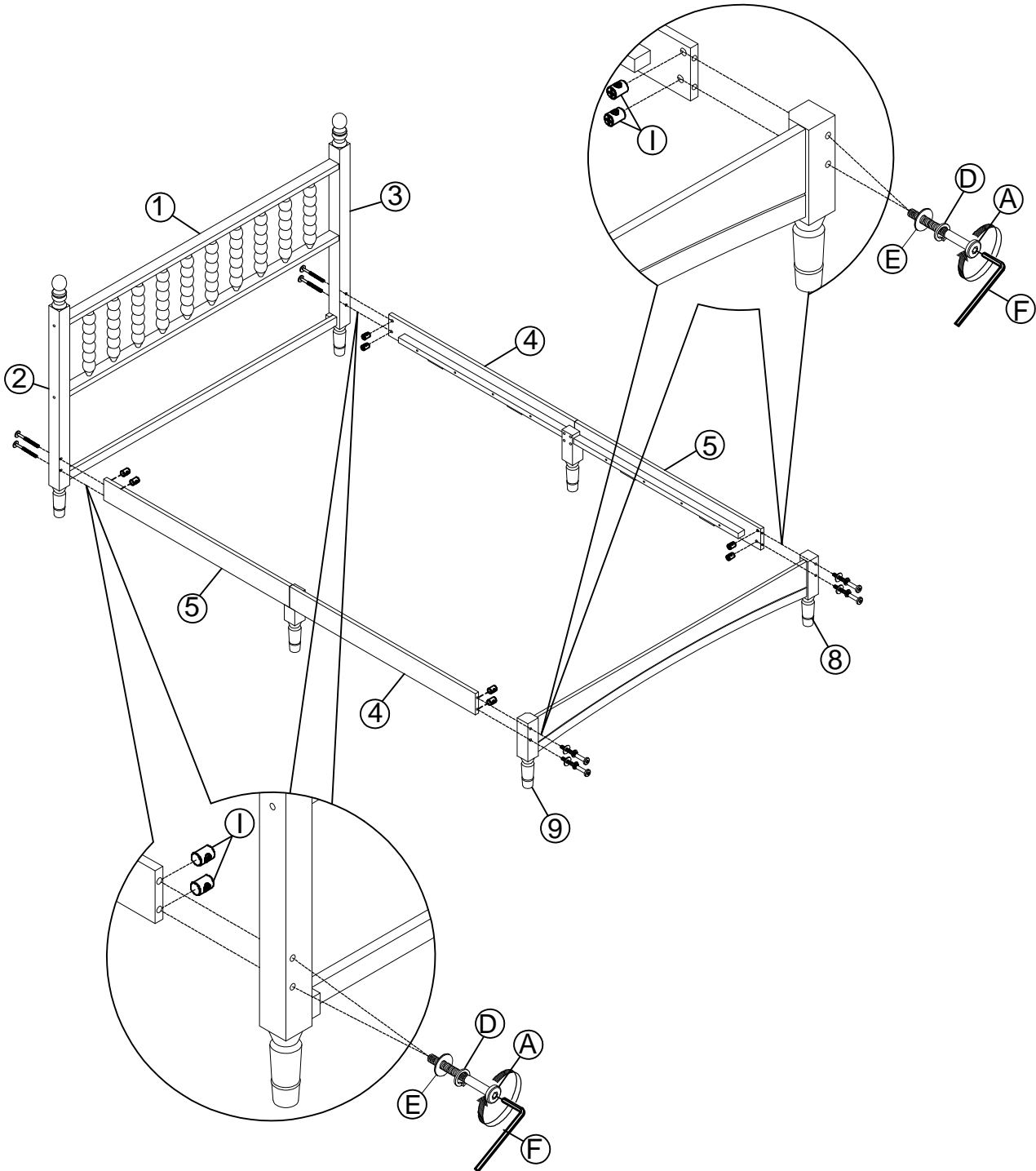

**STEP: 5**  
ÉTAPE

J



20PCS

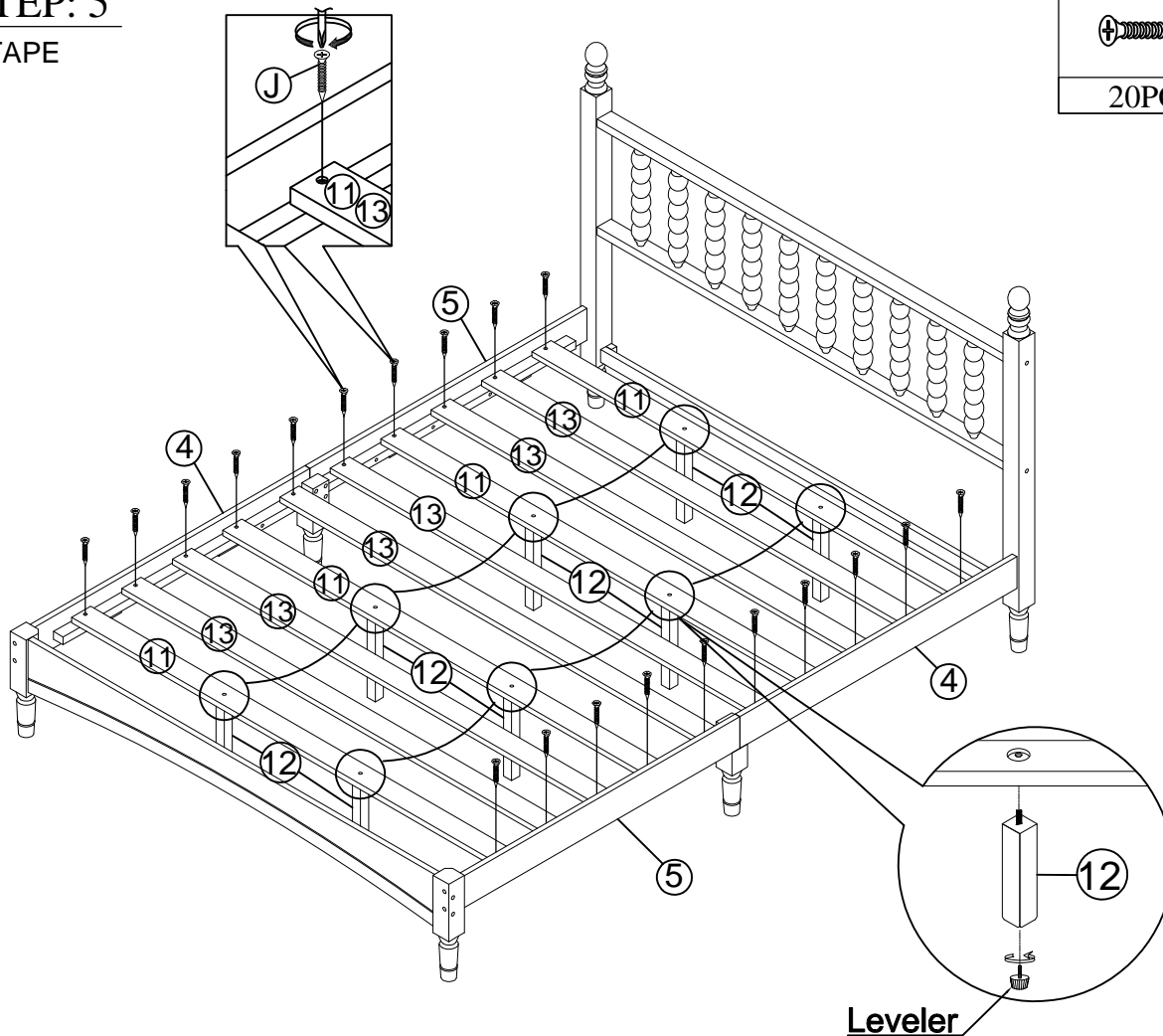

**FINAL**  
FINALE

