

## WARNING

- \* Switch off the main electrical supply from the main fuse box / circuit breaker before installation.
- \* Inspect item carefully before attempting to install.
- \* If there is any damages or obvious defects, do not install.
- \* Item may not be returned once it has been installed.

## CARE AND MAINTENANCE





- \* To clean the outside of the fixture, use a dry or slightly dampened clean cloth (use clean water, never a solvent) to wipe the surface of the fixture.
- \* To clean the inside of the fixture, first disconnect power to the fixture by turning off the circuit breaker or by removing the fuse at the fuse box. Next, use a dry or slightly dampened clean cloth (use clean water, never a solvent) to wipe the interior surface of the fixture.
- \* Do not use any cleaners with chemical, solvents or harsh abrasives. Use only a dry soft cloth to dust or wipe carefully.

## NOTICE& IMPORTANT SAFETY INSTRUCTIONS

- \* Please make sure that you have all parts indicated before you begin assembly of this item
- \* This item should be assembled on a soft surface to prevent scratching the finish during assembly
- \* To reduce the risk of fire, electrical shock or injury to persons or property, please follow the guideline below for safe use and installation
- \*The external flexible cable or cord of this luminaire cannot be replaced  
If the cord is damaged, the luminaire shall be destroyed

## Option 1: Assembly instruction(portable)

### Part List and Hardware List

PIECE	DESCRIPTION	PICTURE	QUANTITY	PIECE	DESCRIPTION	PICTURE	QUANTITY
A	Anchor		2X	D	Shade		1X
B	J-hook		2X	E	Blub		1X
C	Socket		1X				1X

# Owner Manual

Product Dimensions: 16.5"D X 18.5-90.5"H

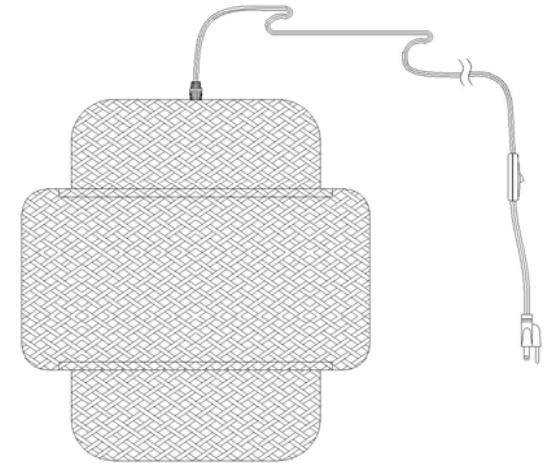

## PREPARATION

- \* Before beginning assembly of product, make sure all parts are present. Compare parts with package contents list and hardware contents list.
- \* If any part is missing or damaged, do not attempt to assemble the product.
- \* Estimated Assembly Time: 30 minutes.
- \* Tools Required for Assembly (not included): Screwdriver, Junction box
- \* If you are having difficulty, our friendly Customer Care team is always here to help.

**NOTE: PLEASE USE TYPE "A" BULB MAX 100-WATT OR LED BULB MAX 12-WATT, THERE ARE 1PCS LED 4-WATT BULB IN THE BOX**

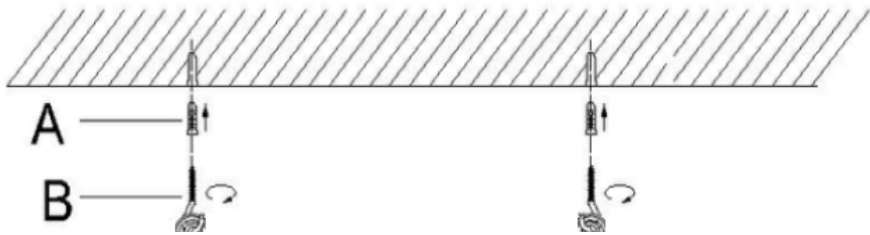

### Step 1:

Drill two holes with depth 1-1/8" into the firm ceiling at the desired location for the lamp (D), Install two anchor (A) into the holes. Insert the J-hook (B) into the anchor (A) and tap gently with a hammer to set anchors firmly in place.

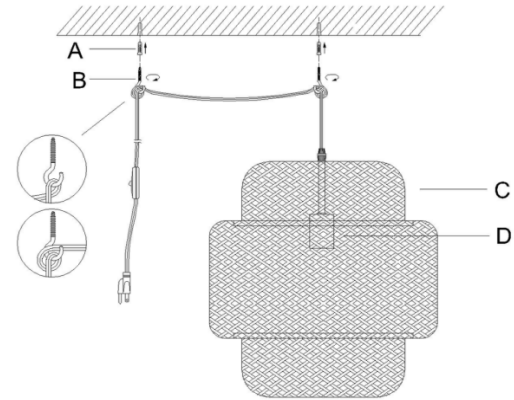

### Step 2:

Adjust the desired location on the cord of lamp (C), Wrap the wire around the J-hook (B) twice. Note: Do not twist the cord.

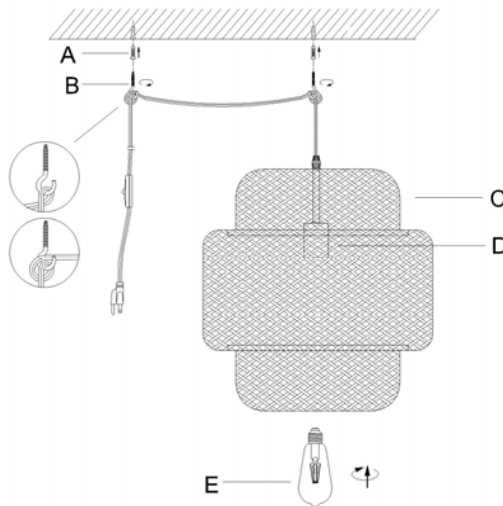

### Step 3:

Install bulb(L). Be sure to use light bulb(L) with wattage no greater than specified on this fixture. Always make sure that electrical current is turned off before changing bulbs. Use the inline switch on cord to turn light on/off. Do not install on a radiant-heating ceiling.

## WARNING

- \* Switch off the main electrical supply from the main fuse box / circuit breaker before installation.
- \* Inspect item carefully before attempting to install.
- \* If there is any damages or obvious defects, do not install.
- \* Item may not be returned once it has been installed.

## CARE AND MAINTENANCE













- \* To clean the outside of the fixture, use a dry or slightly dampened clean cloth (use clean water, never a solvent) to wipe the surface of the fixture.
- \* To clean the inside of the fixture, first disconnect power to the fixture by turning off the circuit breaker or by removing the fuse at the fuse box. Next, use a dry or slightly dampened clean cloth (use clean water, never a solvent) to wipe the interior surface of the fixture.
- \* Do not use any cleaners with chemical, solvents or harsh abrasives. Use only a dry soft cloth to dust or wipe carefully.

## NOTICE& IMPORTANT SAFETY INSTRUCTIONS

- \* Please make sure that you have all parts indicated before you begin assembly of this item
- \* This item should be assembled on a soft surface to prevent scratching the finish during assembly
- \* To reduce the risk of fire, electrical shock or injury to persons or property, please follow the guideline below for safe use and installation
- \*The external flexible cable or cord of this luminaire cannot be replaced  
If the cord is damaged, the luminaire shall be destroyed

## Option 2: Assembly instruction(Hard wired)

### Part List and Hardware List

PIECE	DESCRIPTION	PICTURE	QUANTITY	PIECE	DESCRIPTION	PICTURE	QUANTITY	PIECE	DESCRIPTION	PICTURE	QUANTITY
A	Wire Connrctor		3X	F	Canopy		1X	K	Bulb		1X
B	Mounting Bracket		1X	G	Screwed Balls		2X	L	Bracket		1X
C	Machine Screw		2X	H	Screw Nut		1X				
D	Mounting Screw		2X	I	Shade		1X				
E	Ground Screw		1X	J	Socket		1X				

# Owner Manual

Product Dimensions: 16.5"D X 18.5-90.5"H



## PREPARATION

- \* Before beginning assembly of product, make sure all parts are present. Compare parts with package contents list and hardware contents list.
- \* If any part is missing or damaged, do not attempt to assemble the product.
- \* Estimated Assembly Time: 30 minutes.
- \* Tools Required for Assembly (not included): Screwdriver, Junction box
- \* If you are having difficulty, our friendly Customer Care team is always here to help.

**NOTE: PLEASE USE TYPE "A" BULB MAX 100-WATT OR LED BULB MAX 12-WATT, THERE ARE 1PCS LED 4-WATT BULB IN THE BOX**

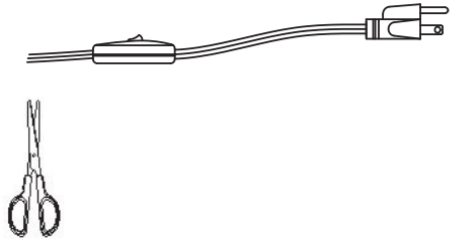

**Note:** Cutting the cord so that they are at least 6 inches (152.4mm) long within an outlet box and extend max. 3.1m long measured from the point where the cord emerges from the body of the lamp.

### Step 1:

Carefully cut pre -attached plug ,cord and switch to your desired length as shown and discard the part plug and switch .

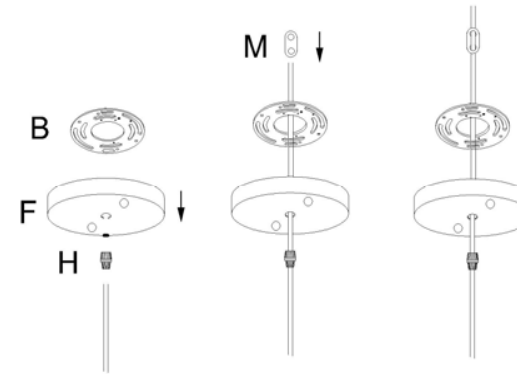

### Step 2:

Insert end of cord into corresponding hole of screw nut ( H ),canopy ( F ),and mounting plate ( B ) as shown. Thread cord into bracket ( M ) as shown.

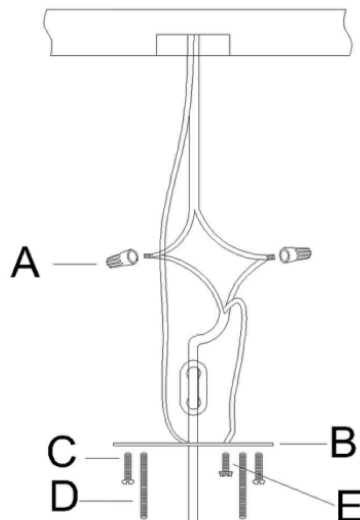

### Step 3:

Fix the mounting bracket(B) to the outlet box with machine screw(C).

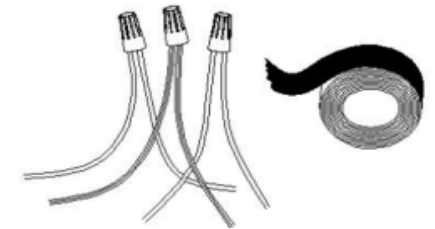
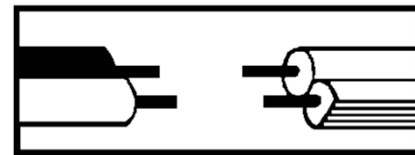

### Step 4:

Make wire connections, with wire nut(A)

Connect fixture neutral wire (ribbed) to the outlet box neutral wire (usually white) using a wire nut. Connect fixture hot wire (smooth with markings) to the outlet box hot wire (usually black) using a wire nut.

CAUTION: Do not reverse the hot and neutral connections

Grounding Instructions:

Wrap ground wire from outlet box around green ground screw(Q) on mounting bracket, no less than 2" from wire end. Tighten ground screw. If fixture is supplied with a ground wire, connect to outlet ground wire with a wire nut.

## PREPARATION

- \* Before beginning assembly of product, make sure all parts are present. Compare parts with package contents list and hardware contents list.
- \* If any part is missing or damaged, do not attempt to assemble the product.
- \* Estimated Assembly Time: 20 minutes.
- \* Tools Required for Assembly (not included): Screwdriver, Junction box
- \* If you are having difficulty, our friendly Customer Care team is always here to help.

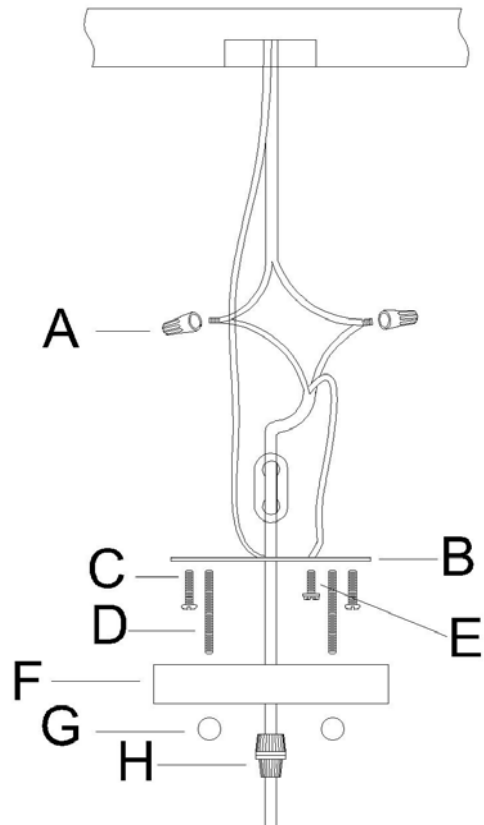

### Step 5:

Orient the ceiling canopy(F) so that the mounting screws(D) protruding from the mounting bracket go into the holes in the canopy, then secure it with the provided screws(G).

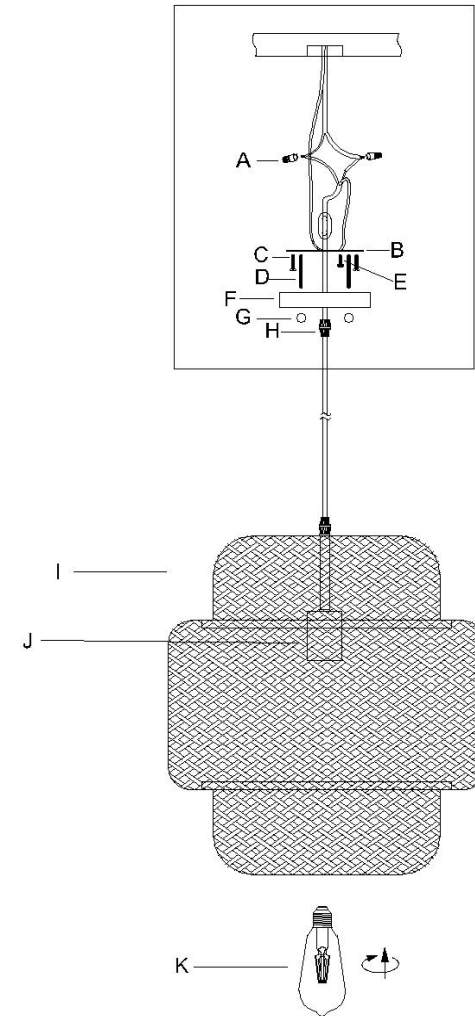

### Step 6:

Install bulb(K). Be sure to use light bulb(K) with wattage no greater than specified on this fixture. Always make sure that electrical current is turned off before changing bulbs.