

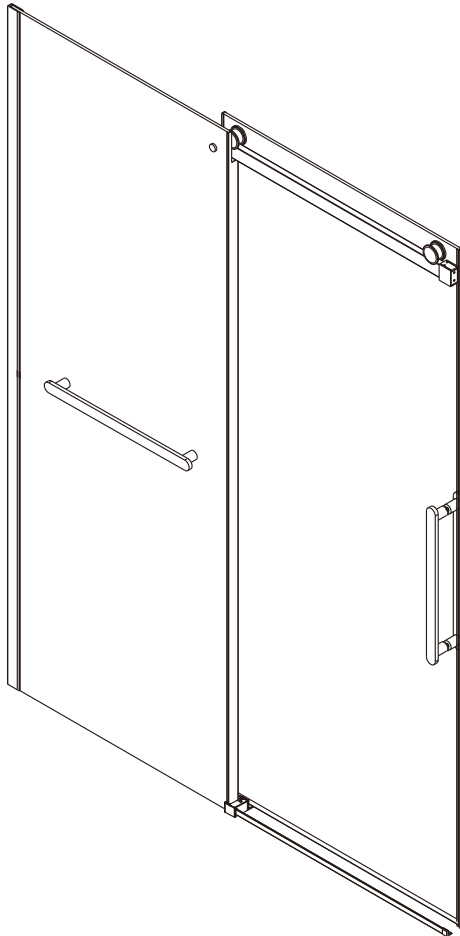

## Installation Instructions **AG2501S-60CH/MB/BN**

---



**V1-2026-01-16**

---

For customer support, please call Avanity Corporation at 866-522-5578 weekdays 9:00 to 5:00 PST  
*Pour le support client, s'il vous plaît appelez au 866-522-5578 Avanity Corporation semaine 9:00-5:00 PST*

## **IMPORTANT SAFETY & INSTALLATION INFORMATION**

### **GENERAL INFORMATION**

- Please read all instructions fully before installation.
- This product should be installed by a qualified installer familiar with shower door construction and tempered glass handling.
- The installer is responsible for ensuring correct installation and compliance with all applicable local building and plumbing codes.
- Product specifications, designs, and instructions may be updated without prior notice.

 Note: All illustrations are for reference only and may not be drawn to scale.

### **INSTALLATION & HANDLING WARNINGS**

- This product contains heavy glass components. Do not attempt to lift or install glass panels alone.
- Always use an assistant and professional-grade glass suction cups when handling glass.
- Do not lean on, apply pressure to, or misuse the glass panels or door.
- Some installations may require drilling into the threshold or base—confirm drilling suitability with the base or flooring manufacturer before proceeding.

### **TEMPERED GLASS SAFETY WARNING**

 **Tempered glass can shatter without warning if damaged, improperly installed, or misused.**

#### **DO NOT:**

- ✗ Install glass with chipped corners, cracked edges, or visible damage
- ✗ Install glass that has been dropped or struck against a hard surface
- ✗ Attempt to cut, drill, or modify tempered glass
- ✗ Slam, force, or aggressively operate the door

#### **ALWAYS:**

- ✓ Protect glass edges and corners during storage, unpacking, and installation
- ✓ Keep corner protectors in place until final installation
- ✓ Ensure all hardware is properly aligned, tightened, and gasketed
- ✓ Inspect glass and hardware periodically for damage or loosening

 Even minor edge damage can cause glass to shatter immediately or hours or days later.

## **INSTALLER RESPONSIBILITY NOTICE**

- Improper installation, loose hardware, or misalignment may place stress on the glass and cause failure.
- Adjustments should be made immediately if misalignment or loose components are detected.
- Extra caution is advised in households with children or elderly users; additional safety measures should be considered.

## **PRE-INSTALLATION CHECKLIST**

Before beginning installation, confirm the following:

- ✓ All parts are present and undamaged
- ✓ Walls are plumb, square, and structurally sound
- ✓ Threshold is level and capable of supporting the product
- ✓ Finished surfaces are protected during installation
- ✓ Proper safety equipment is worn (gloves, safety glasses, footwear)

## **DISCLAIMER & LIABILITY NOTICE**

- Manufacturer is not responsible for damage or injury resulting from improper installation, handling, misuse, or failure to follow instructions.
- Installation of damaged glass voids all warranties and may result in serious injury or property damage.
- This manual must be left with the end user upon completion of installation.



# Tools

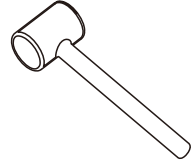
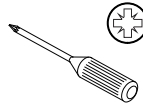
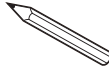
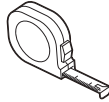
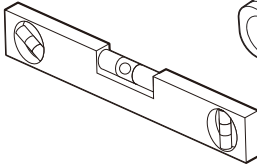

(Ø 1/4")  
(6mm)



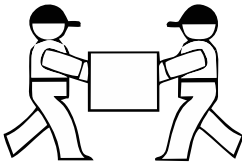
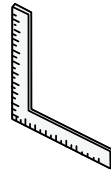
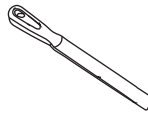
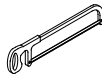
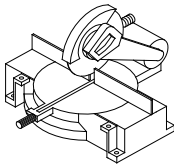
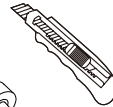
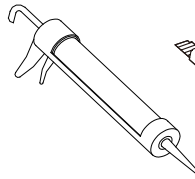

(Ø 1/8")  
(3.2mm)



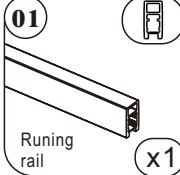
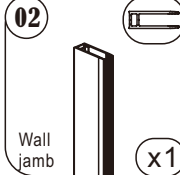
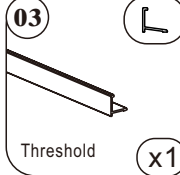
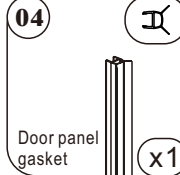
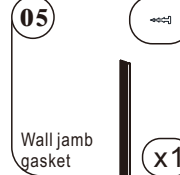
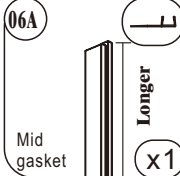
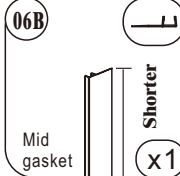
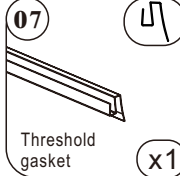
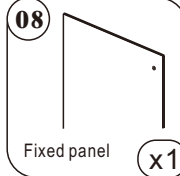
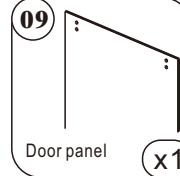
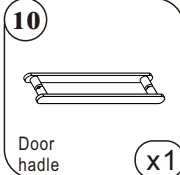
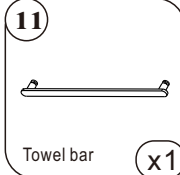
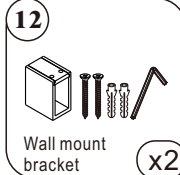
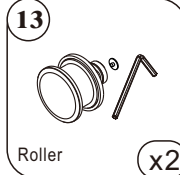
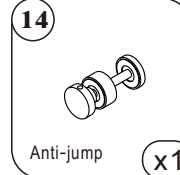
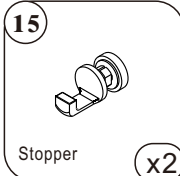
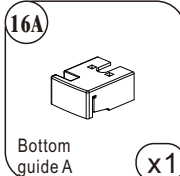
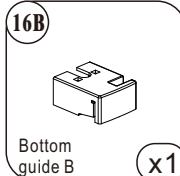
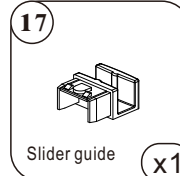
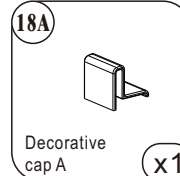
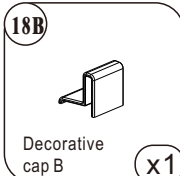
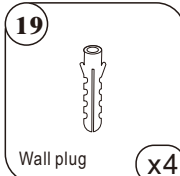
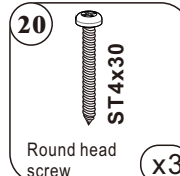

# List

- |  |  |  |  |   |
|--|--|--|--|---|
| <p><b>01</b></p>  <p>Runing rail</p> <p>x1</p>               | <p><b>02</b></p>  <p>Wall jamb</p> <p>x1</p>                  | <p><b>03</b></p>  <p>Threshold</p> <p>x1</p>                        | <p><b>04</b></p>  <p>Door panel gasket</p> <p>x1</p>                | <p><b>05</b></p>  <p>Wall jamb gasket</p> <p>x1</p>   |
| <p><b>06A</b></p>  <p>Mid gasket</p> <p>Longer</p> <p>x1</p> | <p><b>06B</b></p>  <p>Mid gasket</p> <p>Shorter</p> <p>x1</p> | <p><b>07</b></p>  <p>Threshold gasket</p> <p>x1</p>                 | <p><b>08</b></p>  <p>Fixed panel</p> <p>x1</p>                      | <p><b>09</b></p>  <p>Door panel</p> <p>x1</p>         |
| <p><b>10</b></p>  <p>Door hadle</p> <p>x1</p>                | <p><b>11</b></p>  <p>Towel bar</p> <p>x1</p>                  | <p><b>12</b></p>  <p>Wall mount bracket</p> <p>x2</p>               | <p><b>13</b></p>  <p>Roller</p> <p>x2</p>                           | <p><b>14</b></p>  <p>Anti-jump</p> <p>x1</p>          |
| <p><b>15</b></p>  <p>Stopper</p> <p>x2</p>                  | <p><b>16A</b></p>  <p>Bottom guide A</p> <p>x1</p>           | <p><b>16B</b></p>  <p>Bottom guide B</p> <p>x1</p>                 | <p><b>17</b></p>  <p>Slider guide</p> <p>x1</p>                    | <p><b>18A</b></p>  <p>Decorative cap A</p> <p>x1</p> |
| <p><b>18B</b></p>  <p>Decorative cap B</p> <p>x1</p>       | <p><b>19</b></p>  <p>Wall plug</p> <p>x4</p>                | <p><b>20</b></p>  <p>Round head screw</p> <p>ST4x30</p> <p>x3</p> | <p><b>21</b></p>  <p>Round head screw</p> <p>ST4x25</p> <p>x1</p> | <p><b>22</b></p>  <p>Auxiliary tools</p> <p>x1</p>  |

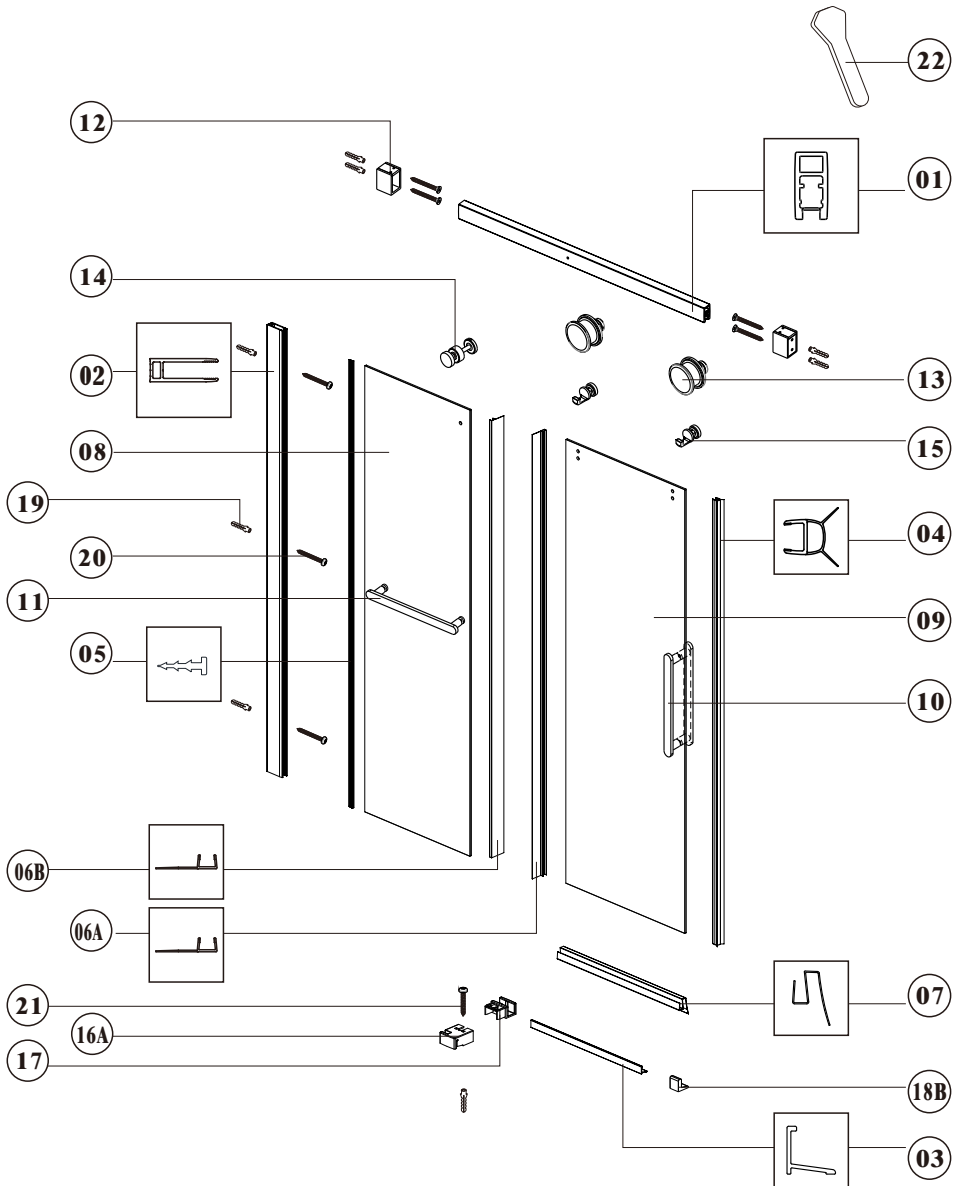

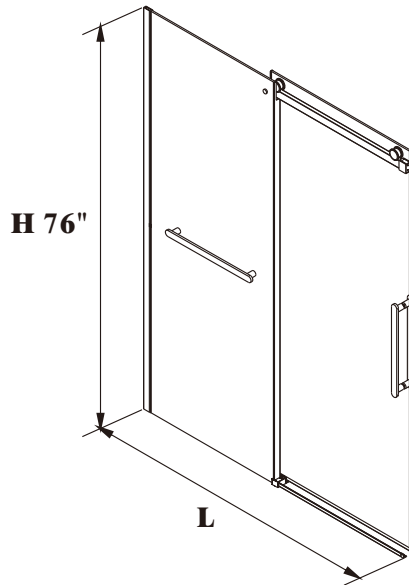
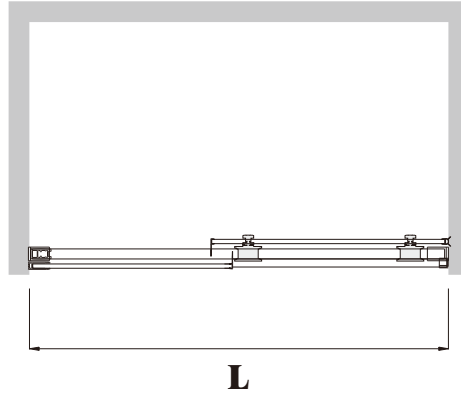

Code	Size	L (Min~Mix)	Colour	Glass
AG2501S-60CH	60"x76"	56"-60"	Chrome	5/16"-Easy-clean
AG2501S-60MB	60"x76"	56"-60"	Matt black	5/16"-Easy-clean
AG2501S-60BN	60"x76"	56"-60"	Brushed nickel	5/16"-Easy-clean

# 01

Measure the width of the shower door opening at the top, middle, and bottom to ensure the opening dimensions are correct before installation.

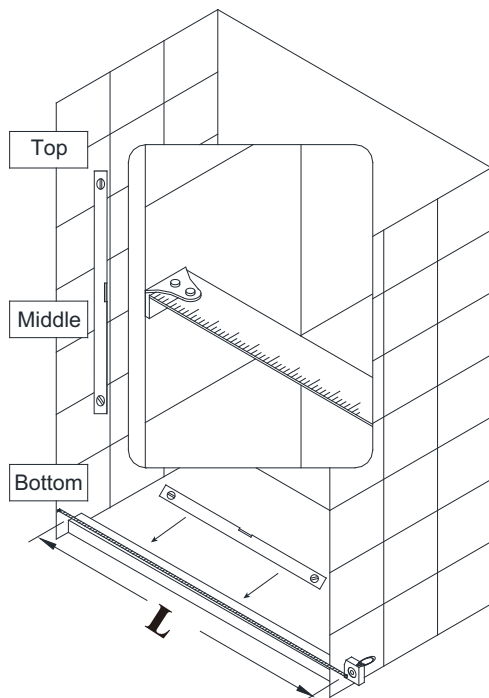

### Tools Needed

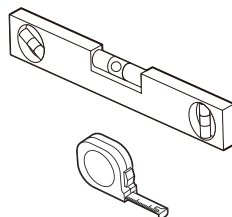

# 02

Measure the distance from the edge of the fixed panel (08) to the hole. Measure the distance from the edge of the running rail (01) to the hole.

Requirement:  $L1=L2$

△Note: The end corresponding to dimension L1 must not be cut.

Measure the distance between the two walls as L (refer to page 7 ).

Calculate the required installation dimension L3 using the formula:  $L3=L-0.5$  inch

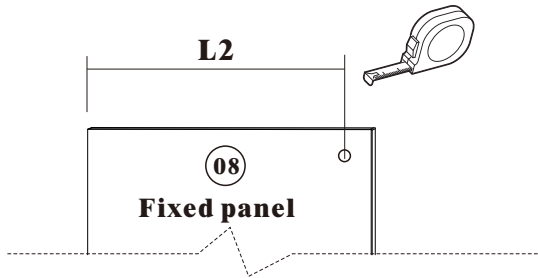

$$L1 = L2$$

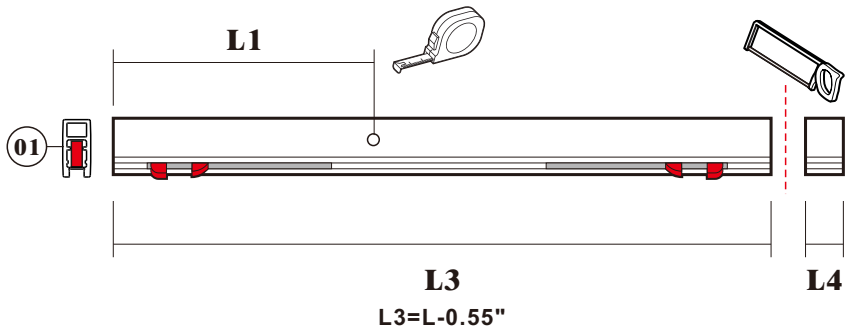
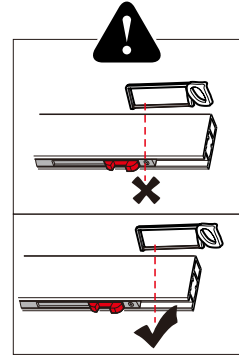

### Parts Needed

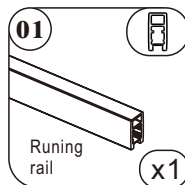

### Tools Needed

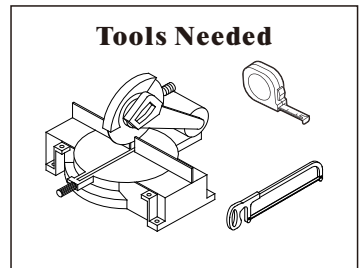

# 03

Install the wall jamb(02), ensuring it is vertical and at least 0.2" away from the water-retaining edge.  
Drill holes, insert wall plugs, and fasten the wall jamb securely with screws.

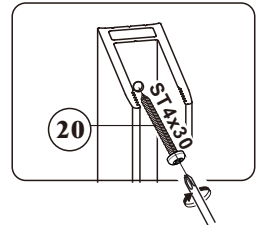
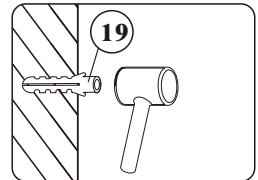
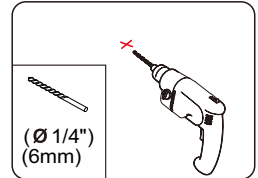
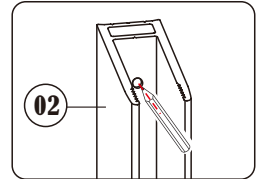
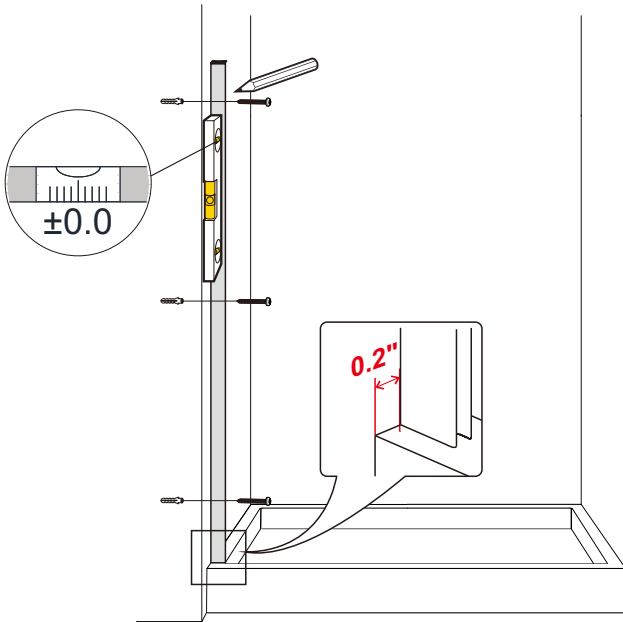

## Parts Needed

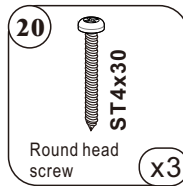
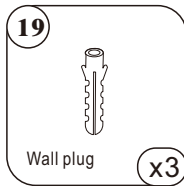
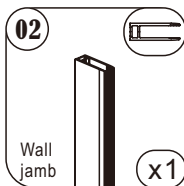

## Tools Needed

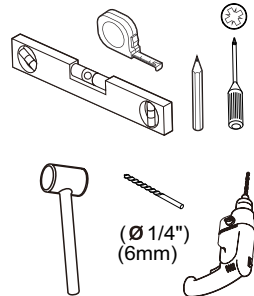

# 04

Lift the door glass panel (09) inside. Ensure the corner protectors of the door glass panel are securely attached. Place a cardboard sheet under the door glass panel to protect it.

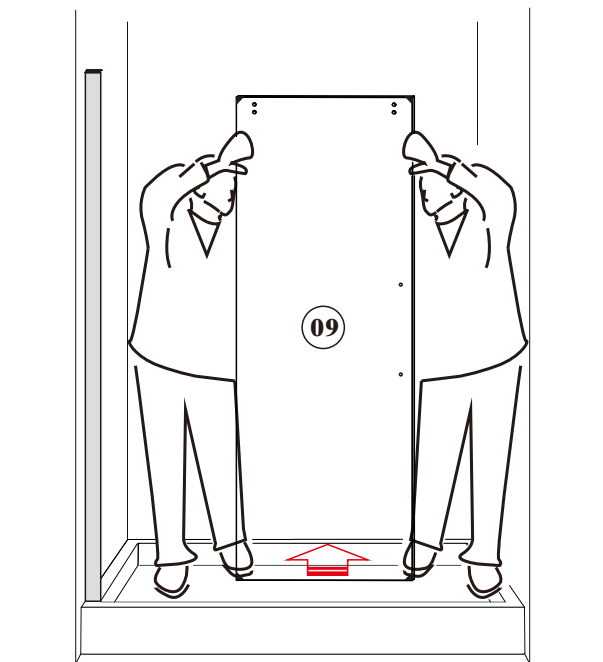
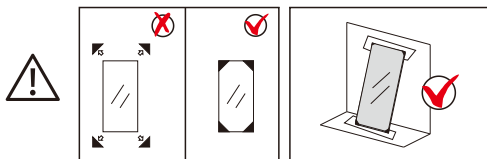

### Parts Needed

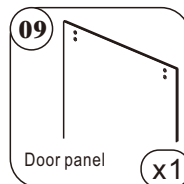

**05**

Clip the fixed glass panel (08) into the wall jamb (02). A 0.9" adjustment range is available between the wall profile and the fixed panel. After adjustment, insert the gasket (05) into the gap between the glass and the wall profile. Hold the glass securely during installation to prevent it from tipping over.

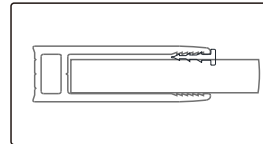
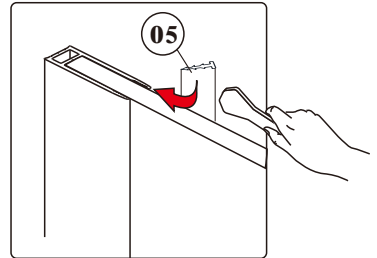
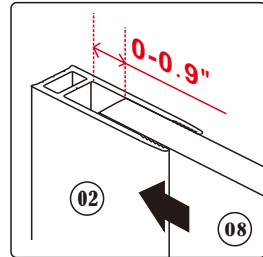
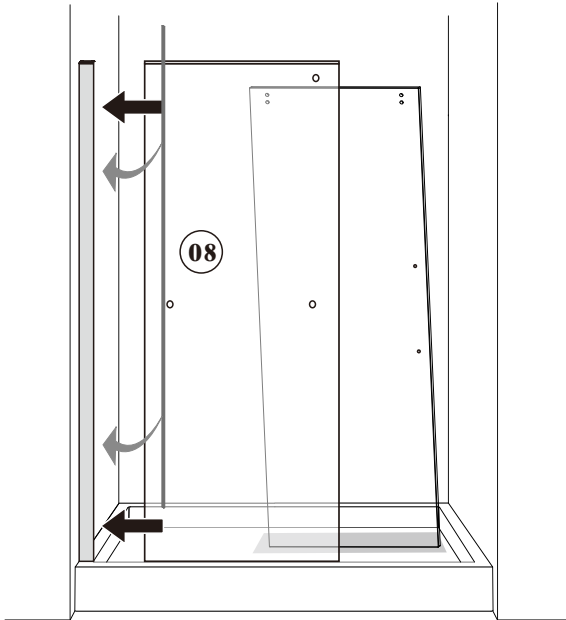
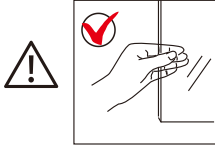

**Parts Needed**

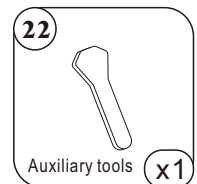
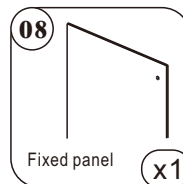
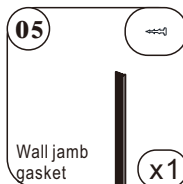

# 06

Clip the wall mount bracket (12) onto both ends of the running rail (01).

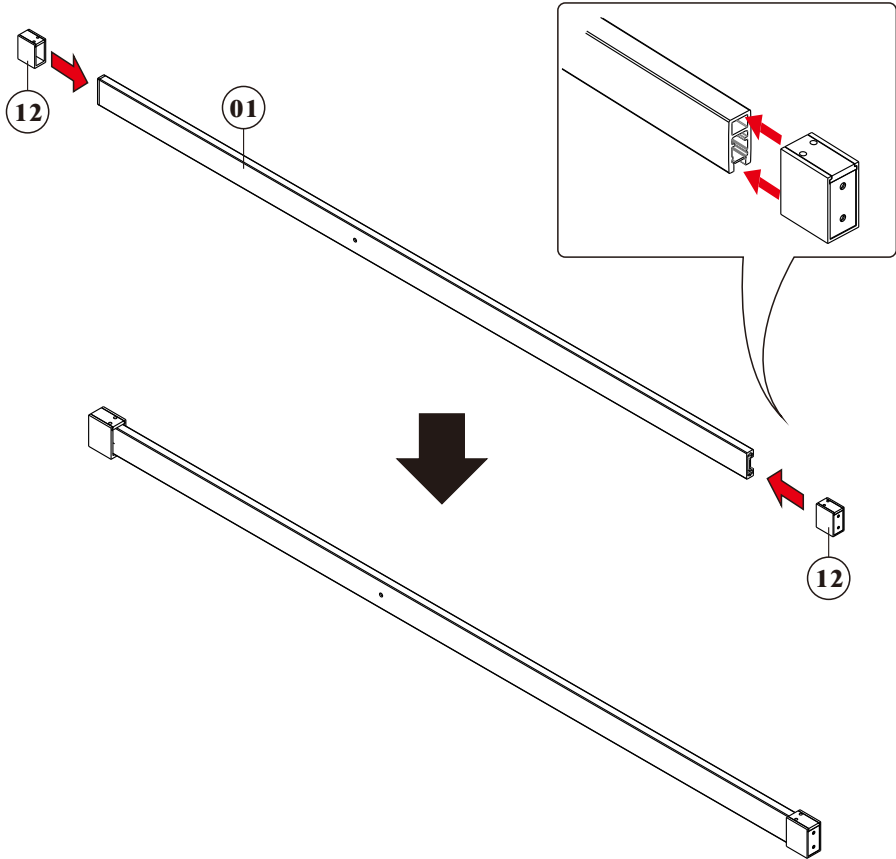

### Parts Needed

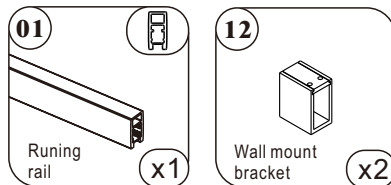

### Tools Needed

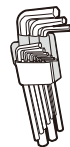

**07**

Disassemble the anti-jump(14).  
Use the anti-jump(14) to fasten the running rail (01) and fixed panel (08) together.

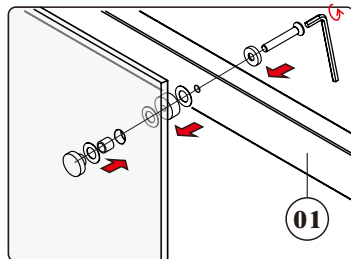
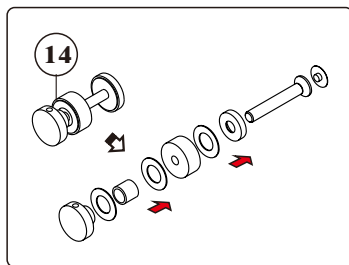
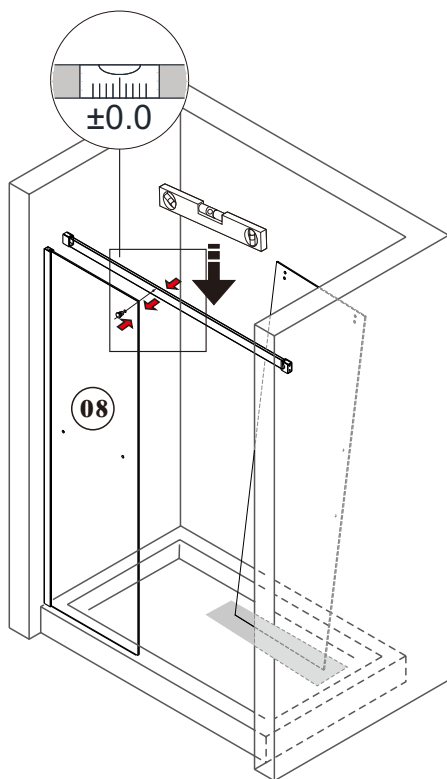
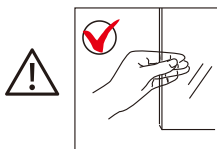

**Parts Needed**

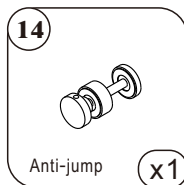

**Tools Needed**



**08**

Mark the wall along the areas where the wall mount bracket(12) are attached to it.

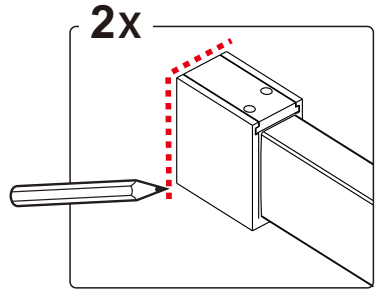
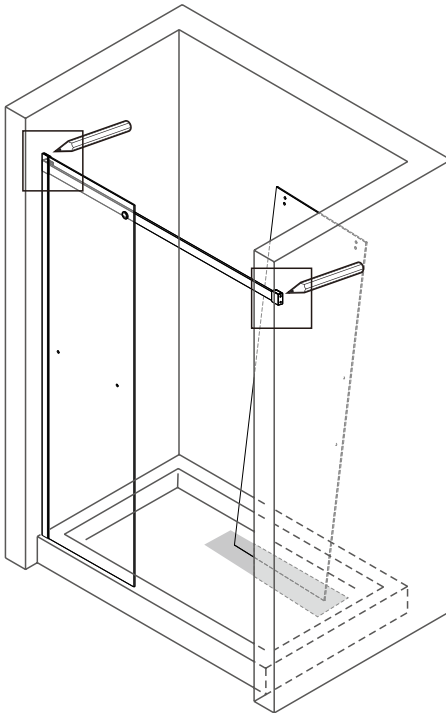

**Tools Needed**



**09** Disassemble the anti-jump(14).

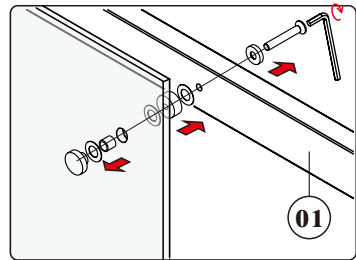
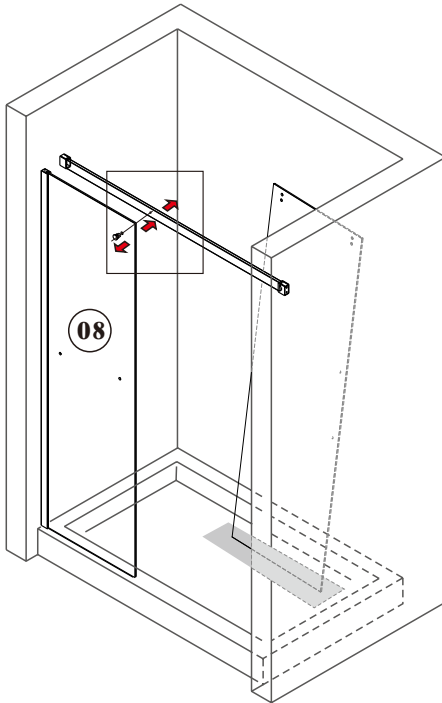

**Tools Needed**

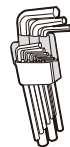

# 10

Remove the wall mount bracket (12) from both ends of the running rail.  
Take off the covers.  
Place the marked wall bracket at the marked positions on the wall.  
Mark the hole locations on the wall.  
Drill holes, insert wall plugs, and fasten the wall mount bracket securely.

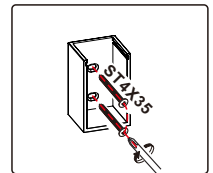
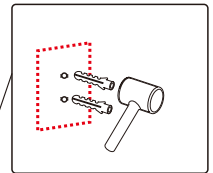
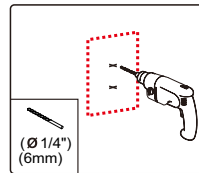
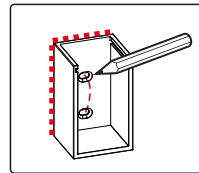
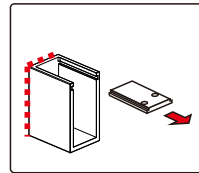
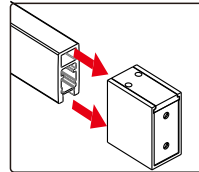
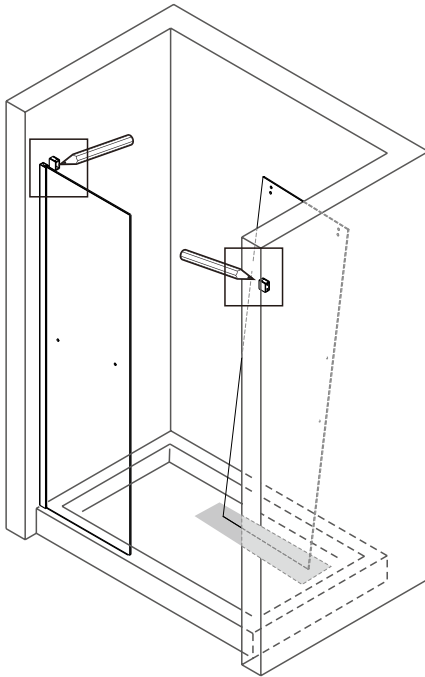

## Parts Needed

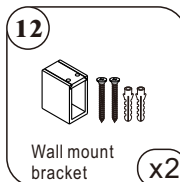

## Tools Needed

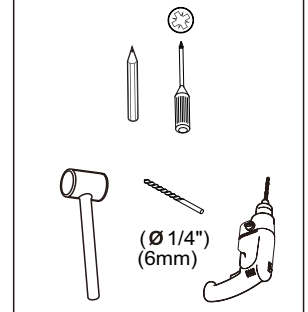

**11**

Clip both ends of the running rail (01) into the wall mount bracket. Install the anti-jump(14) simultaneously.

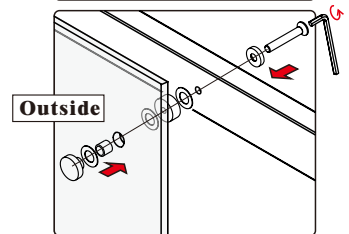
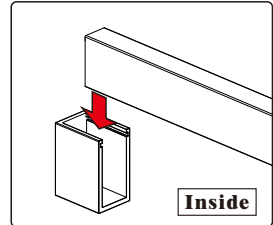
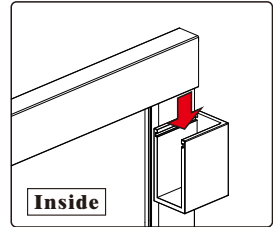
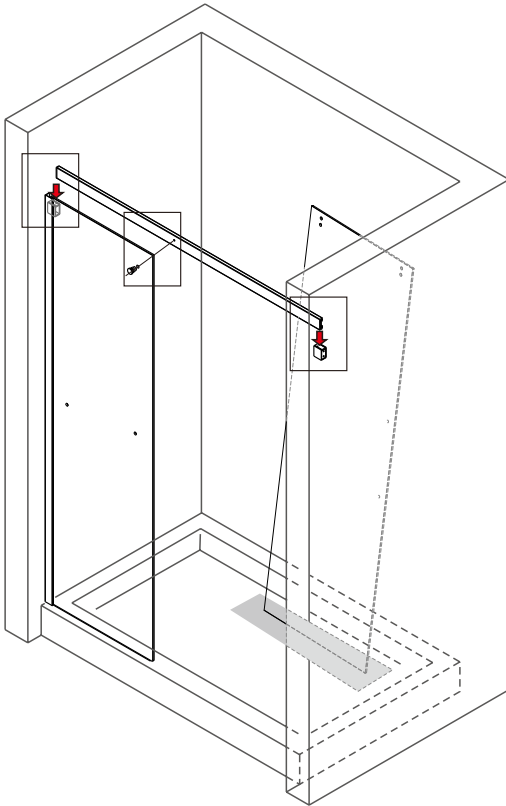

**Parts Needed**

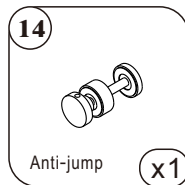
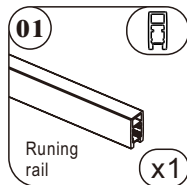

**Tools Needed**

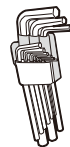

- 12** Fit the covers onto the anti-jump(14) and wall mount bracket (12).  
Tighten them securely with an Allen key.

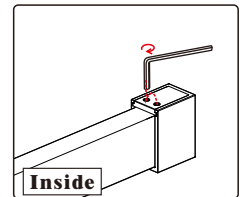
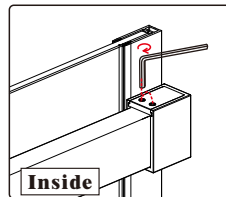
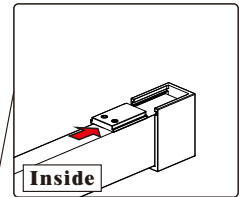
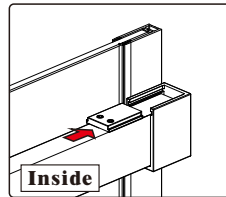
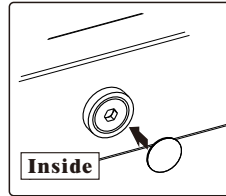
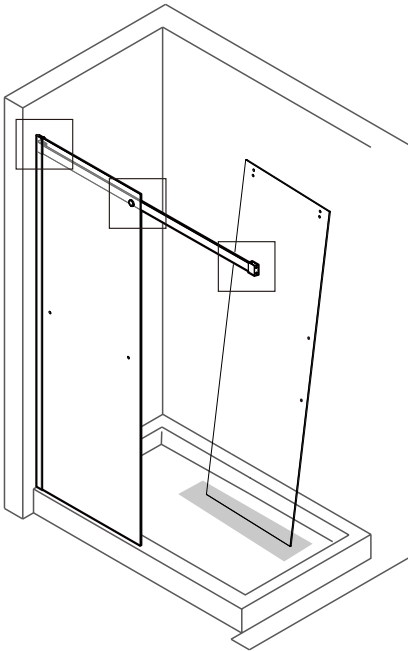

**Parts Needed**

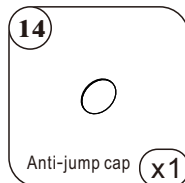
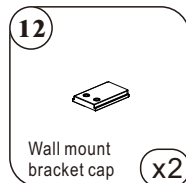

**Tools Needed**

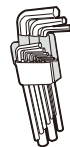

**13**

Measure the distance from the edge of the fixed panel to the wall.  
Calculate the dimension of the threshold(03) using the formula:  $L5=L4-0.2"$ .  
Trim off the excess match dimension L5.

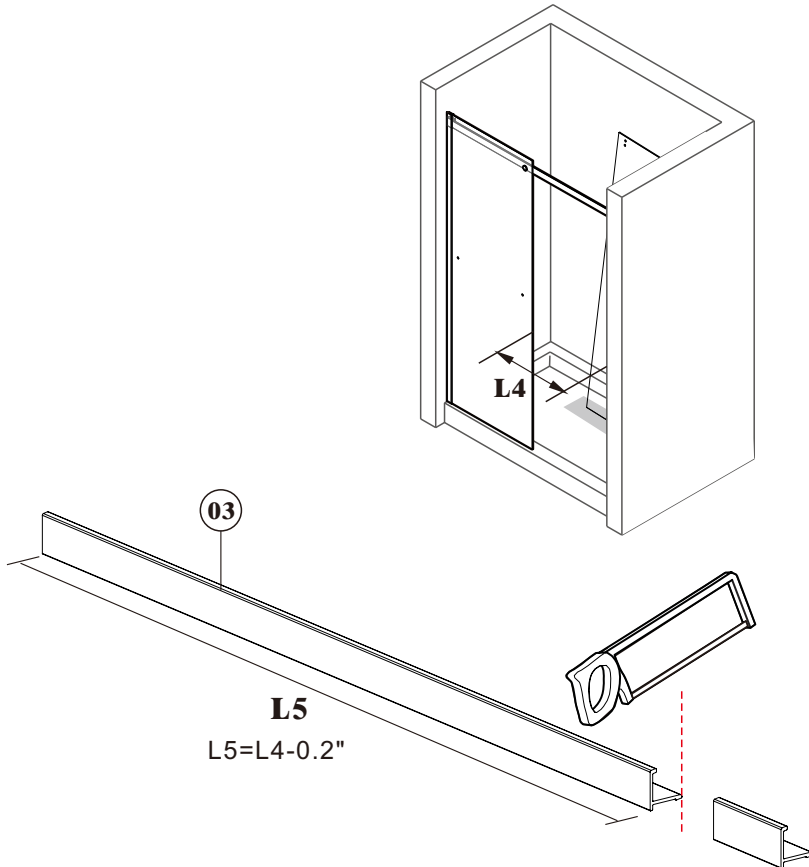

**Parts Needed**

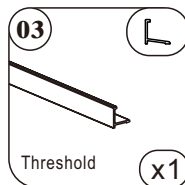

**Tools Needed**

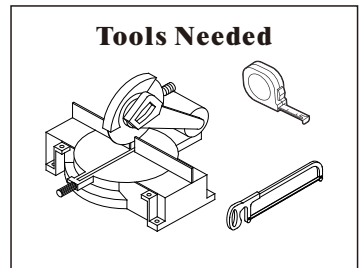

**14**

△ Note: The bottom guide are differentiated by left and right sides.

**LH**

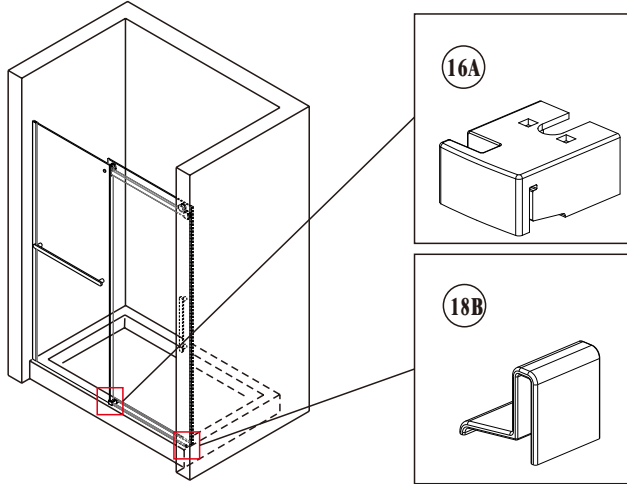

**RH**

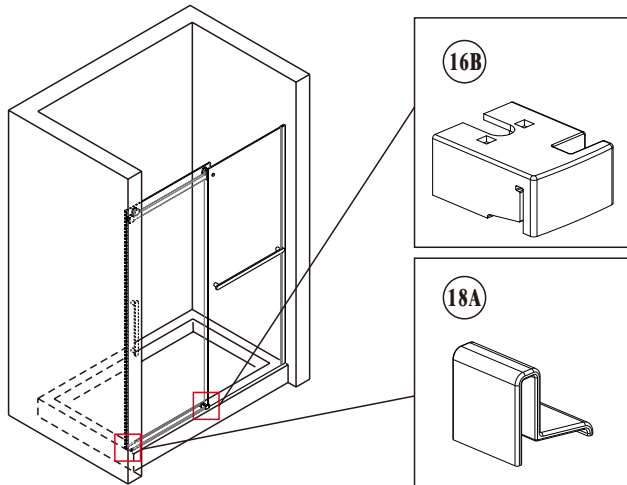

**15**

Clip the bottom guide (16) onto the fixed panel.  
Mark the hole positions through the holes of the bottom guide(16).  
Drill holes and insert wall plugs.

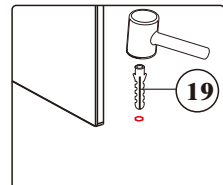
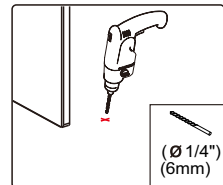
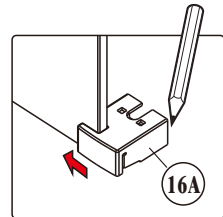
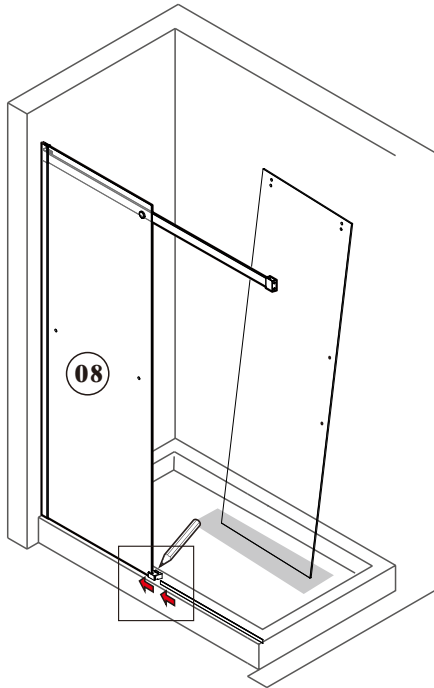

**Parts Needed**

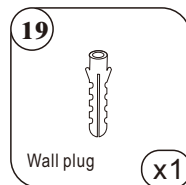
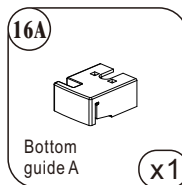

**Tools Needed**



**16**

Apply silicone sealant to the threshold (03), then clip it into the bottom guide (16) and fasten with screws.  
Apply silicone sealant to the decorative cap(18), then cover it.

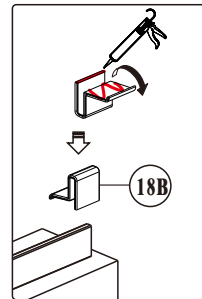
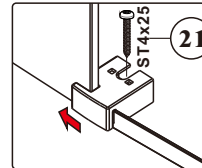
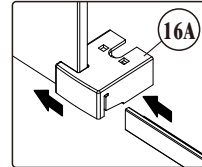
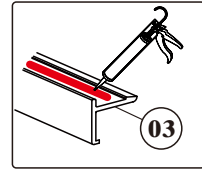
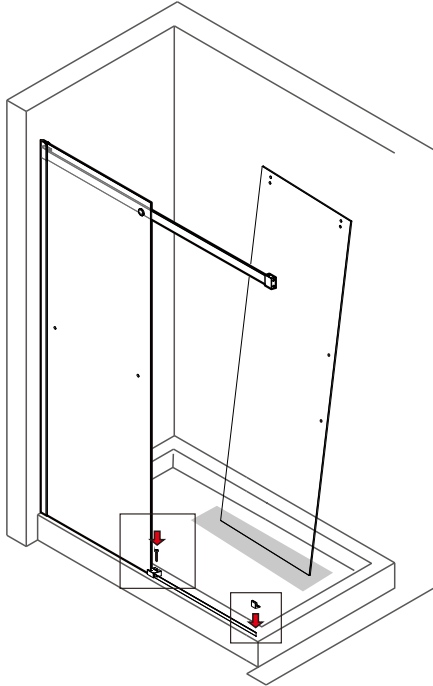

**Parts Needed**

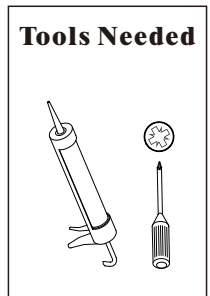
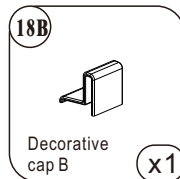
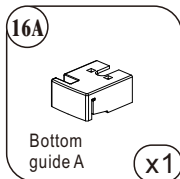
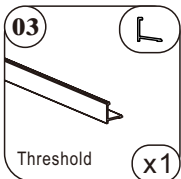

**17** Install the roller(13) on the door panel (09).

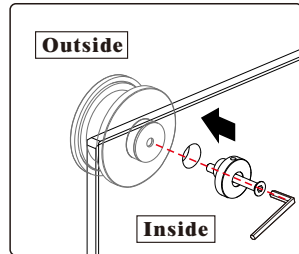
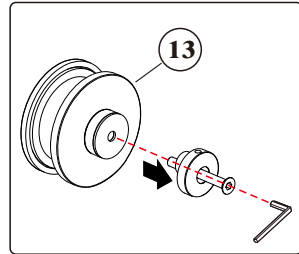
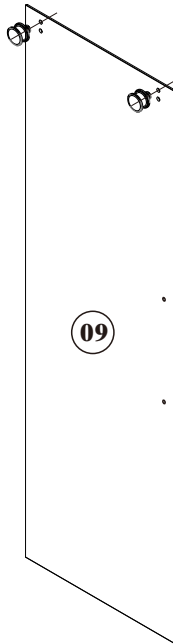

**Parts Needed**

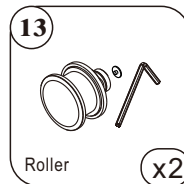
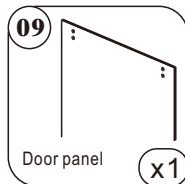

**Tools Needed**

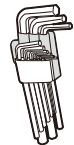

**18**

Install the threshold gasket (07) on the door panel (09).  
Start installing the gasket 0.24 "away from the edge of the glass.

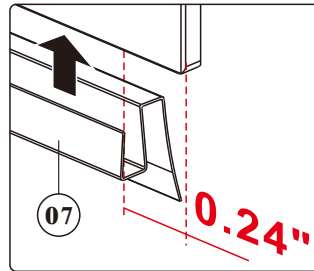
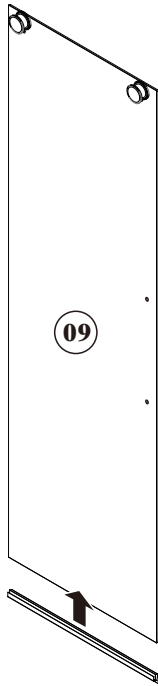

**Parts Needed**

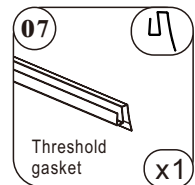
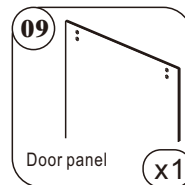

**19** Adjust the bumpers in the running rail .

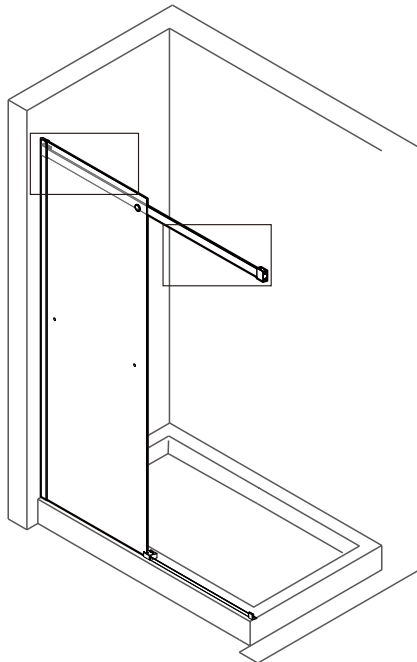
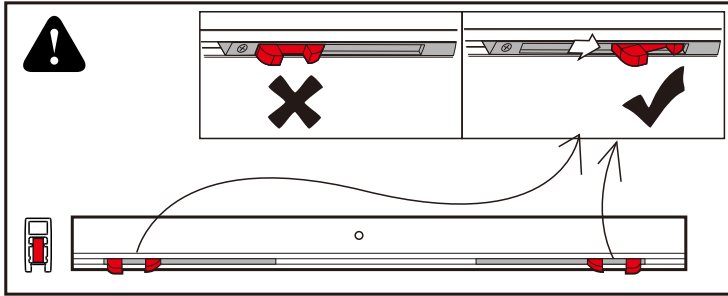

# 20

Clip the bottom slider (17) onto the door panel (09).  
Place the roller onto the running rail.  
Assemble the bottom slider (17) with the bottom guide(16).

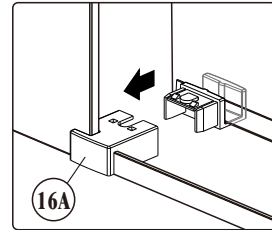
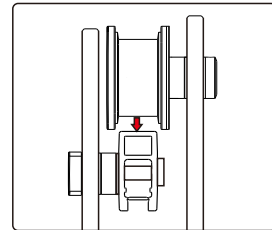
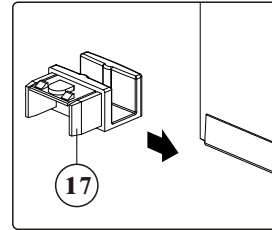
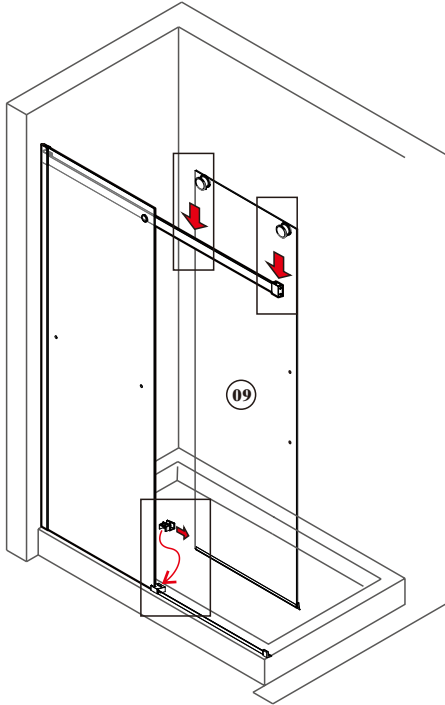

## Parts Needed

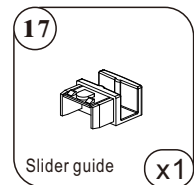

**21**

Install the handle on the door panel.

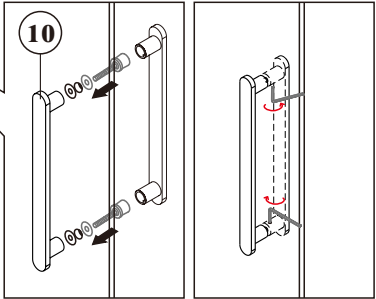
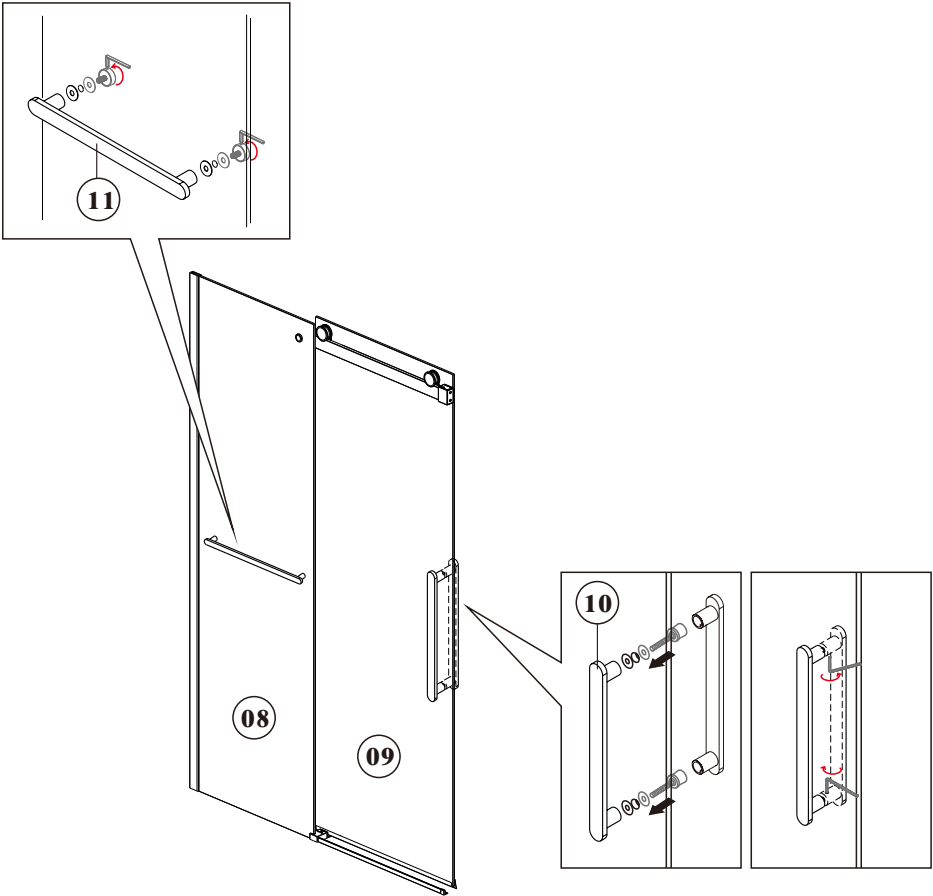

**Parts Needed**

**10**

Door handle **x1**

**11**

Towel bar **x1**

**Tools Needed**



**22**

Install mid gasket (06) and Door panel gasket (04) on the door panel (09).  
Cut the gasket (06) to the required size before installation.

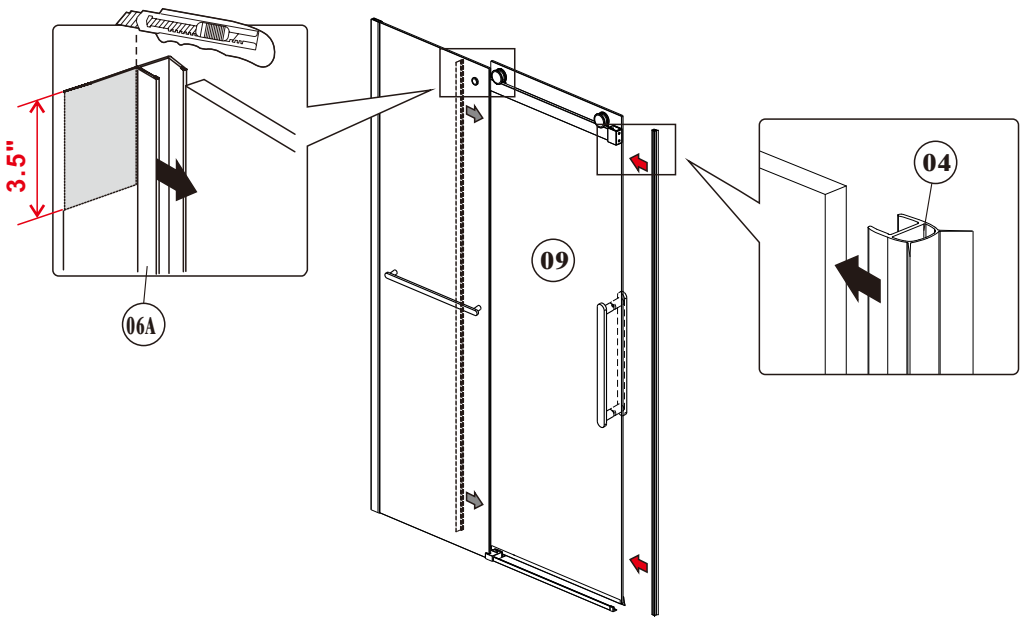

**Parts Needed**

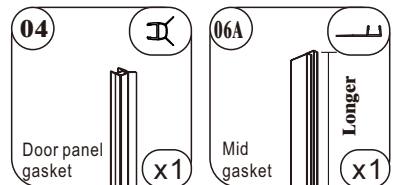

**23**

Install mid gasket on the fixed panel (08).  
Cut the gasket(06) to the required size before installation.

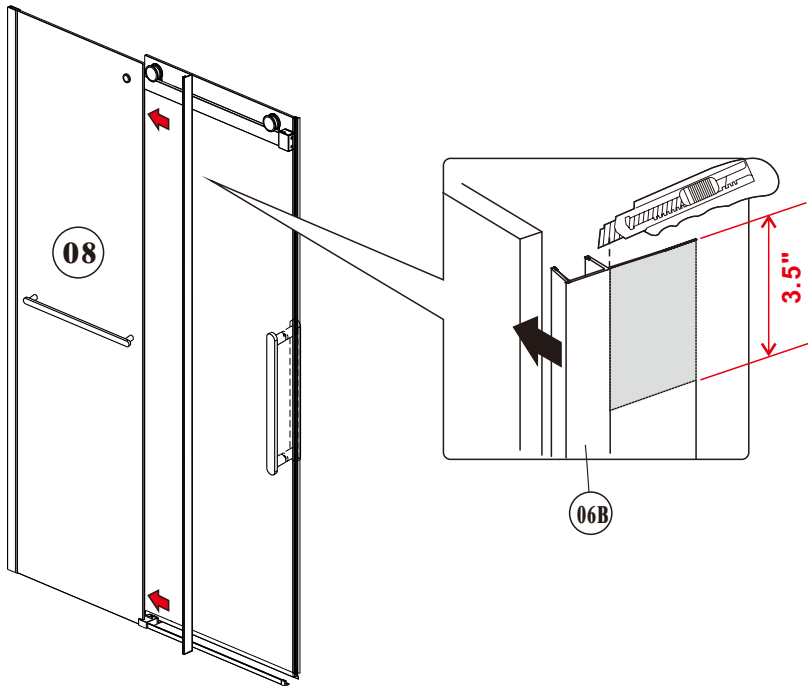

**Parts Needed**

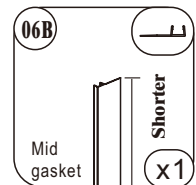

**24**

If the door glass panel is not level, adjust the roller until it is balanced.  
After adjustment, fit the caps in place.

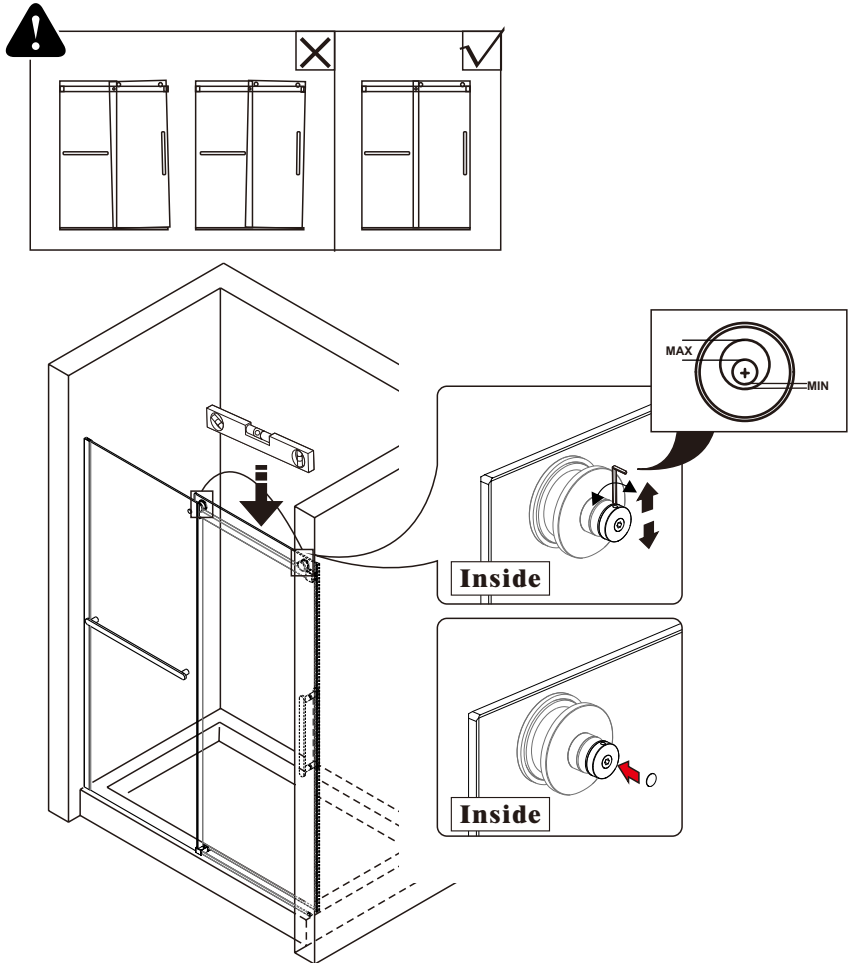

**Parts Needed**

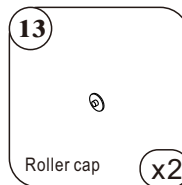

**Tools Needed**

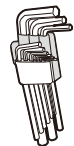

**25** Install the stopper (15).

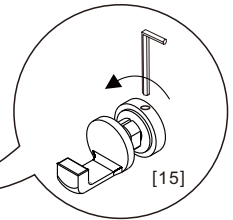
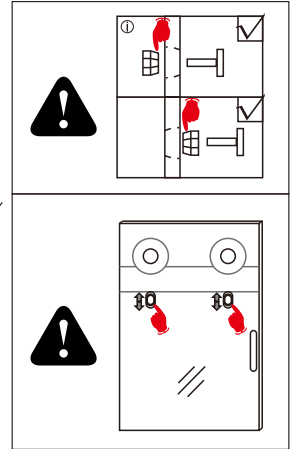
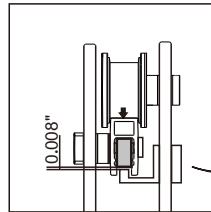
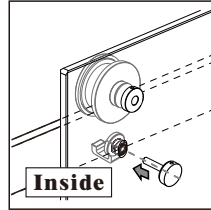
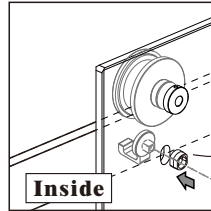
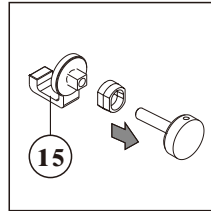
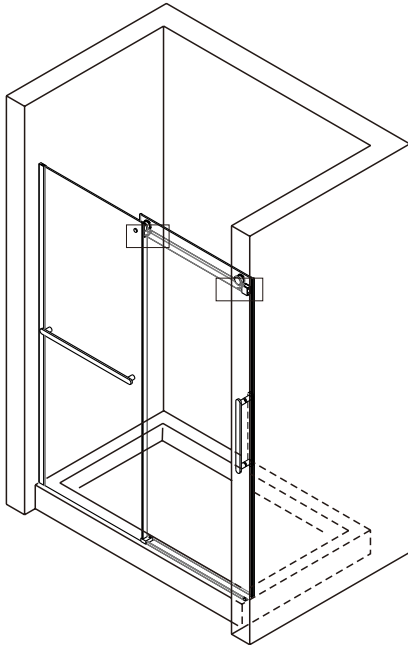

**Parts Needed**

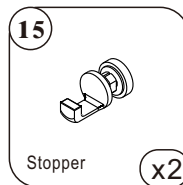

**Tools Needed**

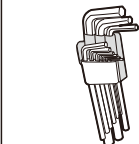

# 26

If there is still a gap after the door is closed, follow the steps shown in the figure below: loosen the bumper first, adjust the door horizontally until it closes completely without gaps, then tighten the bumper.

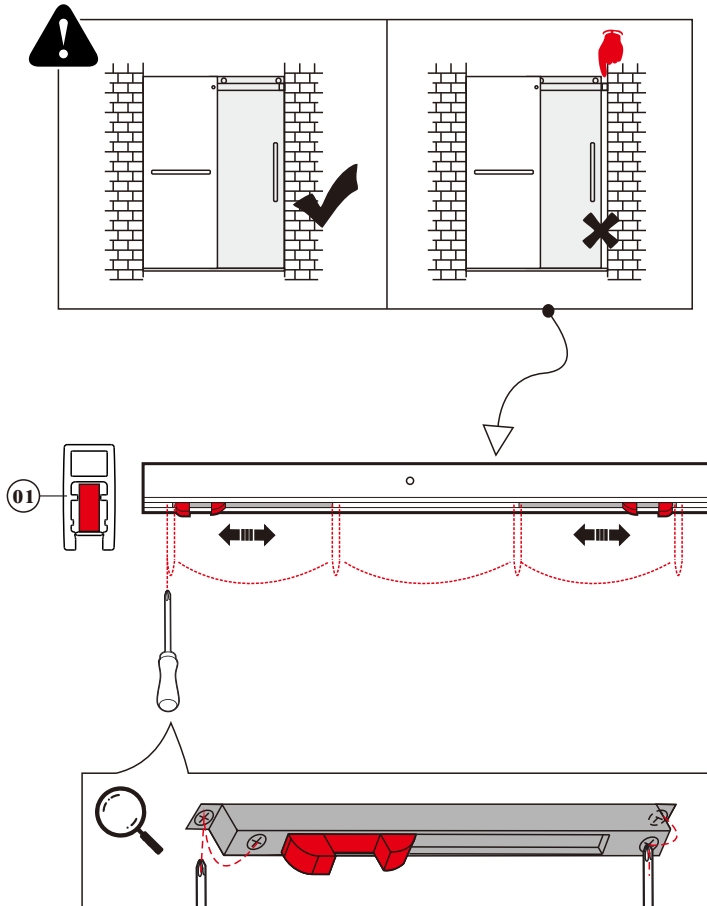

**Tools Needed**



**27**

Apply silicone sealant only to the outside edge. Allow 24 hours for the sealant to dry before using the door.

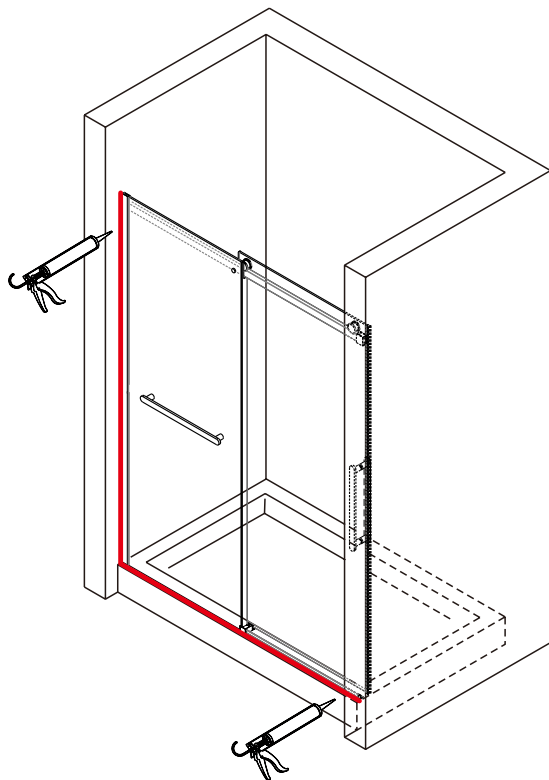

**Tools Needed**

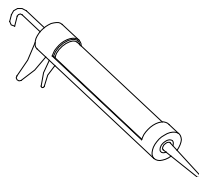

## Routine Inspection & Care

To maintain safe operation and extend the life of your shower door, we recommend periodic inspection of the glass and hardware components.

- Verify the enclosure is stable and operates smoothly
- Check that all screws and fasteners are tight
- Confirm the sliding door moves freely and aligns correctly
- Inspect glass edges for chips, cracks, or damage
- Examine seals and silicone for gaps or deterioration

If any damage or misalignment is detected, discontinue use until the issue has been corrected.



## Glass Care

- Wipe glass surfaces after each use with a soft cloth or squeegee to reduce water spots and soap residue.
- Clean using mild soap and water or a non-abrasive glass cleaner.
- Do not use abrasive cleaners, scouring pads, or metal brushes, as these may damage the glass surface.

NOTE: Hard water deposits left to dry may permanently mark the glass over time.



## Hardware Care

- Dry metal components after use to maintain finish quality.
- Clean with a soft cloth and mild cleaner only.
- Do not use cleaners containing bleach, ammonia, acid, or abrasives.
- Rinse and dry thoroughly after cleaning.



## Sealant Maintenance

- Inspect silicone seals periodically for cracking or separation.
- Replace silicone as needed to prevent water leakage.

## Troubleshooting Guide

Before contacting customer support, please have your **model number**, **purchase information**, and **installation date** available.

Issue	Possible Causes	Solutions
<b>Door does not slide smoothly</b>	• Rollers not aligned or loose	• Check roller alignment and tighten fixings
	• Debris in track or guide	• Clean track and guides
	• Bottom guide incorrectly positioned	• Reposition bottom door guide as needed
<b>Door does not close evenly</b>	• Roller height misadjusted	• Adjust roller height to align door
	• Wall profiles not plumb	• Verify wall profiles are level and plumb
<b>Water leakage</b>	• Seals incorrectly installed	• Check seal orientation and placement
	• Incomplete silicone seal	• Apply silicone along full interior perimeter
	• Seals installed incorrectly	• Reinstall seals correctly
	• Door not closing fully	• Adjust door alignment to ensure full closure
<b>Door rubbing or contacting threshold</b>	• Threshold not level	• Confirm threshold is level
	• Rollers set too low or high	• Adjust roller height
	• Bottom guide misaligned	• Reposition bottom doorguide
<b>Door feels loose or unstable</b>	• Loose screws or brackets	• Tighten all screws and fasteners
	• Anti-jump stops not secured	• Secure anti-jump components
	• Bottom guide missing or loose	• Check bottom guide installation
<b>Glass panels misaligned</b>	• Improper glass positioning	• Reposition glass panels
	• Fixings not tightened evenly	• Tighten fixings evenly from the inside
<b>Noise during operation</b>	• Rollers not seated correctly	• Check roller seating in guide rail
	• Guides contacting glass incorrectly	• Adjust guides to prevent binding
<b>Silicone peeling or leaking</b>	• Poor surface preparation	• Remove and reapply silicone
	• Shower used before silicone cured	• Allow at least 24 hours curing time before use