

Features

- For use with a handshower and hose (sold separately)
- Coordinates with other products in the Exhale collection
- Metal construction

Material

- KOHLER finishes resist corrosion and tarnishing

Installation

- Wall-mount
- Easy installation using slip-fit connection
- Includes 1218069 supply adapter
- May require other adapter based on installation type (sold separately)



Adapters, Rough-in and Extension Kits

1229031	Range: 0" (0 mm) - 1/2" (13 mm)
1247986	Range: 5/16" (8 mm) - 13/16" (21 mm)
1247985	Range: 13/16" (21 mm) - 1-5/16" (33 mm)
1247984	Range: 1-5/16" (33 mm) - 1-13/16" (46 mm)
1218070	Range: 2-5/16" (59 mm) - 2-13/16" (71 mm)
1218071	Range: 2-13/16" (71 mm) - 3-5/16" (84 mm)

Included Components

1218069 Supply Adapter ASM-1.813-2.313 Rough-In

Codes/Standards







ASME A112.18.1/CSA B125.1

KOHLER[®] Faucet Lifetime Limited Warranty

See website for detailed warranty information.

Available Colors/Finishes

Color tiles intended for reference only.

Color	Code	Description
	CP	Polished Chrome
	SN	Vibrant [®] Polished Nickel
	BN	Vibrant [®] Brushed Nickel
	2MB	Vibrant [®] Brushed Moderne Brass
	TT	Vibrant Titanium
	BGP	Brushed Graphite

Supply Adapter	A
1218069 (included)	1-13/16" – 2-5/16" (46 mm – 59 mm)
1229031*	0 – 1/2" (0 – 13 mm)
1247986*	5/16" – 13/16" (8 mm – 21 mm)
1247985*	13/16" – 1-5/16" (21 mm – 33 mm)
1247984*	1-5/16" – 1-13/16" (33 mm – 46 mm)
1218070*	2-5/16" – 2-13/16" (59 mm – 71 mm)
1218071*	2-13/16" – 3-5/16" (71 mm – 84 mm)

*Sold Separately

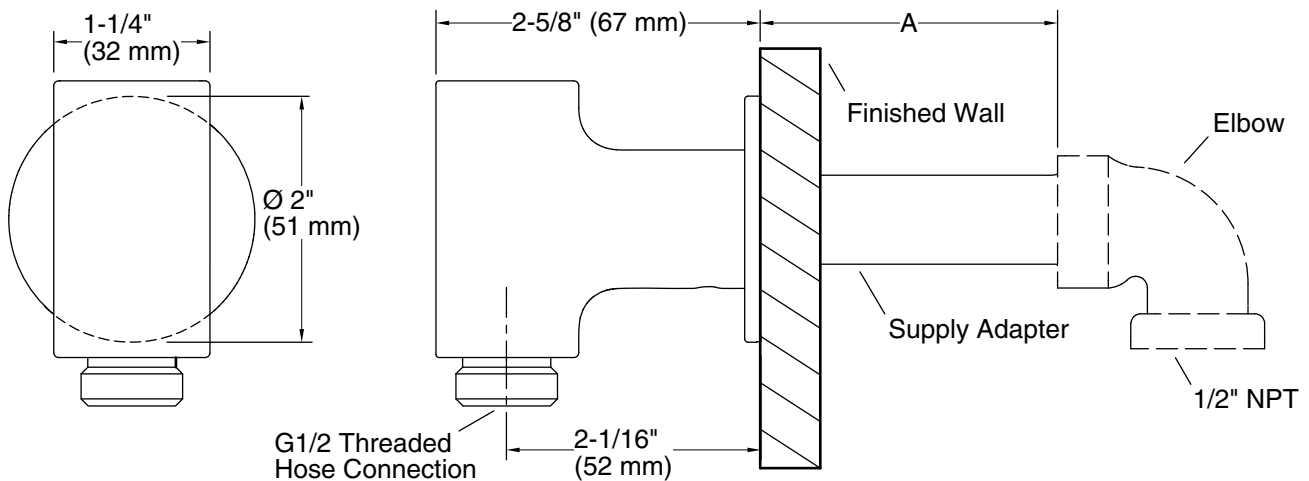

Technical Information

All product dimensions are nominal.

Spout:

Notes

Install this product according to the installation guide.

If dimension "A" is between 1-13/16" (46 mm) and 2-5/16" (59 mm) use the included supply adapter. For the other dimensions, order the appropriate supply adapter.