

**** Do not tighten any bolts until all of them have been started !**

Step 1.

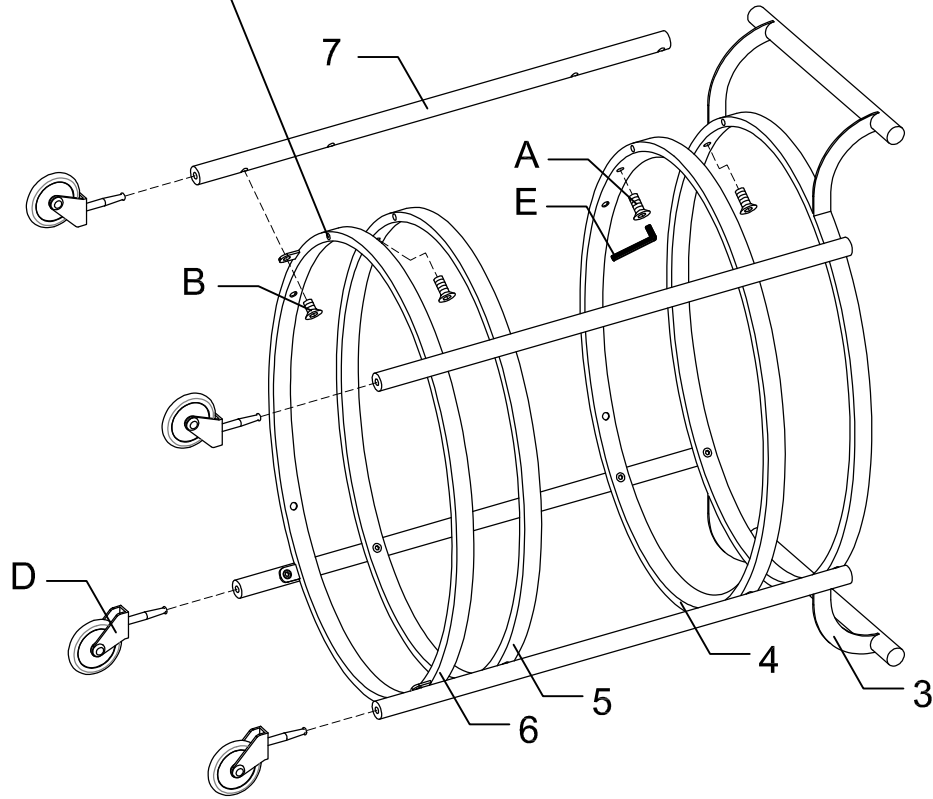



NOTE: Please note there are drain holes in the ring. Please make sure the drain hole faces down in assembly.

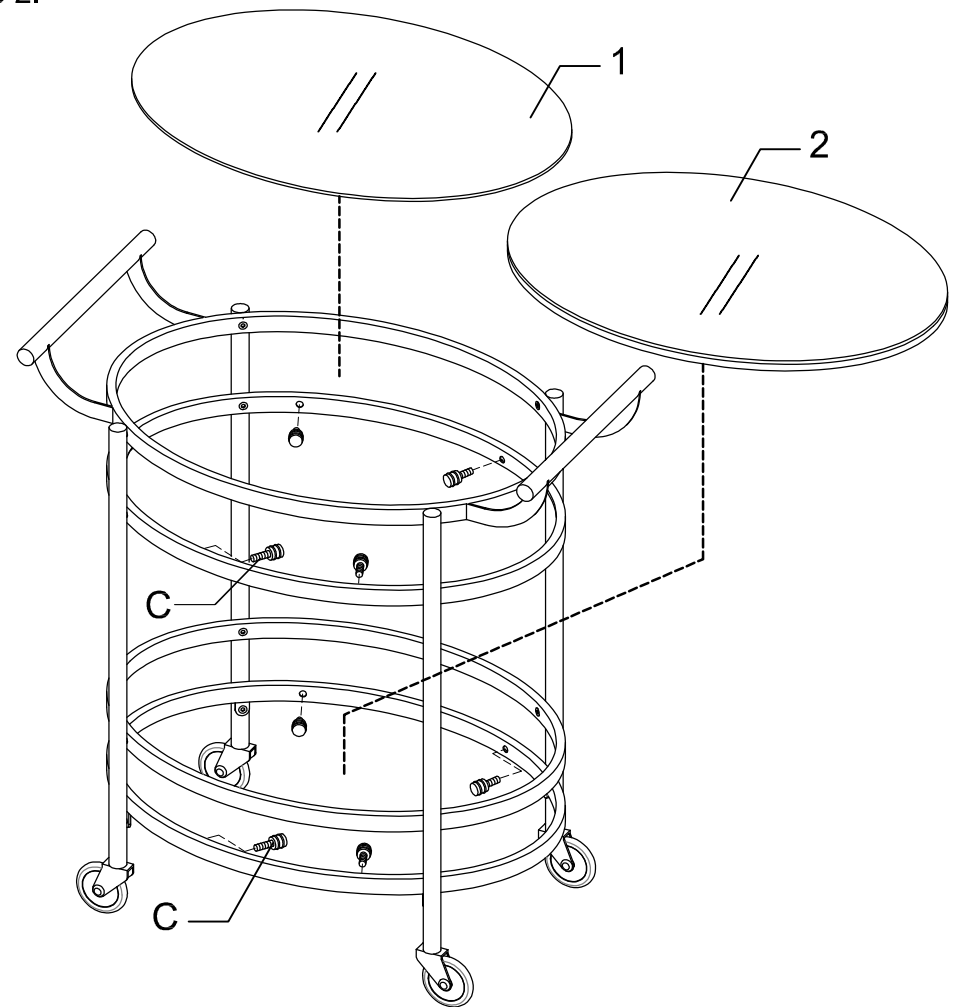



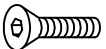

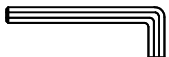

Step 2.

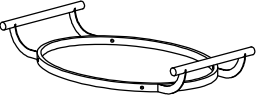

ACCESSORY PACK

<p>A</p>  <p>12+1PCS</p>	<p>B</p>  <p>4PCS</p>	<p>C</p>  <p>8PCS</p>	<p>D</p>  <p>4PCS</p>	<p>E</p>  <p>1PC</p>
---	--	--	--	---

COMPLETE HARDWARE

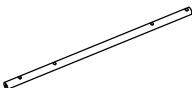
<p>1</p>  <p>glass 1PC</p>	<p>2</p>  <p>mirror 1PC</p>	<p>3</p>  <p>1PC</p>	<p>4</p>  <p>1PC</p>	<p>5</p>  <p>1PC</p>	<p>6</p>  <p>1PC</p>	<p>7</p>  <p>4PCS</p>
---	--	---	---	---	---	--