

Owner Manual



Hardware List

A2		Screw m3.5 x 14mm	124 pcs	L1		Leg Pin	2 pcs
A7		Screw m4 x 30mm	12 pcs	L2		Plastic Leg L Shape	4 pcs
A10		Screw m4 x 38mm	8 pcs	M19		2 Way Slide_406mm	2 sets
A17		Screw m6.3 x 40mm	28 pcs	N1		Allen Key	1 pc
A34		Euro Screw m5 x 8mm	8 pcs	P		Hanging Steel Pipe 18mm x 588mm	2 pcs
A40		TH Screw m4 x 10mm	4 pcs	Q4		Plastic Shelf Support with Steel Pin	8 pcs
D4		Wood Dowel 6 x 25mm	32 pcs	R1		L Bracket	2 pcs
E5		Soft Closing Hinge 5/8	10 pcs	R2		Single Plastic Cap	40 pcs
E21		Anti-Tipping Pack	2 sets	S2		Door Stopper	2 pcs
F2		Mini Fit 15mm	8 sets	Y		Crosshead Cover	20 pcs
H21		Handle 128mm	6 pcs				

*** Extra screw for your commitment.**

*** Please assemble flat or nice service.**

"Congratulations on Your Recent Purchase! Here Are Some Tips Before You Begin Assembling:"

"Preparing for your exciting new purchase? Be sure to set yourself up for a smooth assembly process by following these steps:"

- First, we recommend using a rug or any large clean surface as your workspace to provide a sturdy base for assembly.
- Next, it is important to separate all components and identify each part by their designated letters. This will make it easier to follow the assembly instructions and ensure all pieces are placed correctly.
- Additionally, on a clean surface separate and identify all screws lengths and hardware. You can use the assembly instructions as a guide and place the screws on top of the actual size pictured. This will save you time and confusion during the assembly process.
- Finally, we highly encourage you to carefully read through the assembly instructions and start from step one. Follow each step diligently until your new purchase is fully assembled. However, if you have any questions or need further assistance, please do not hesitate to reach out to us via email.

**Thank you again for choosing our product.
We wish you all the best and happy assembling!**

WP FURNITURE / INSTRUCTIONS

Place your screw on top of the scale to identify their size.

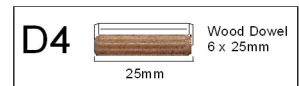
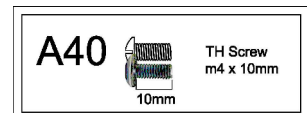
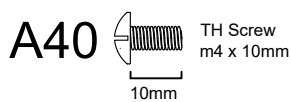
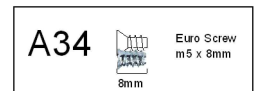
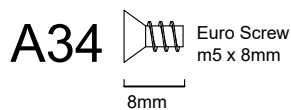
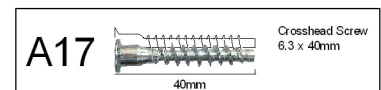
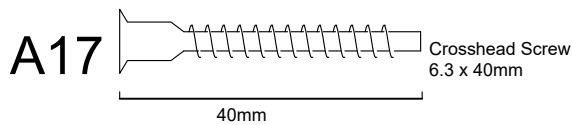
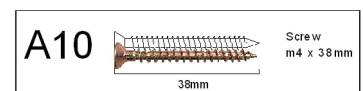
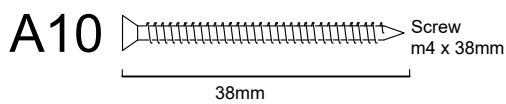
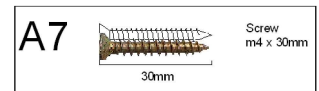
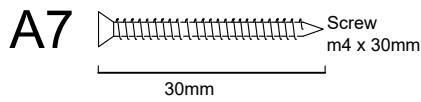
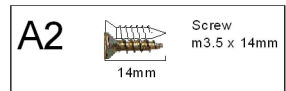
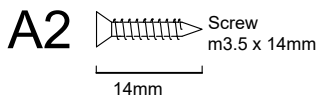

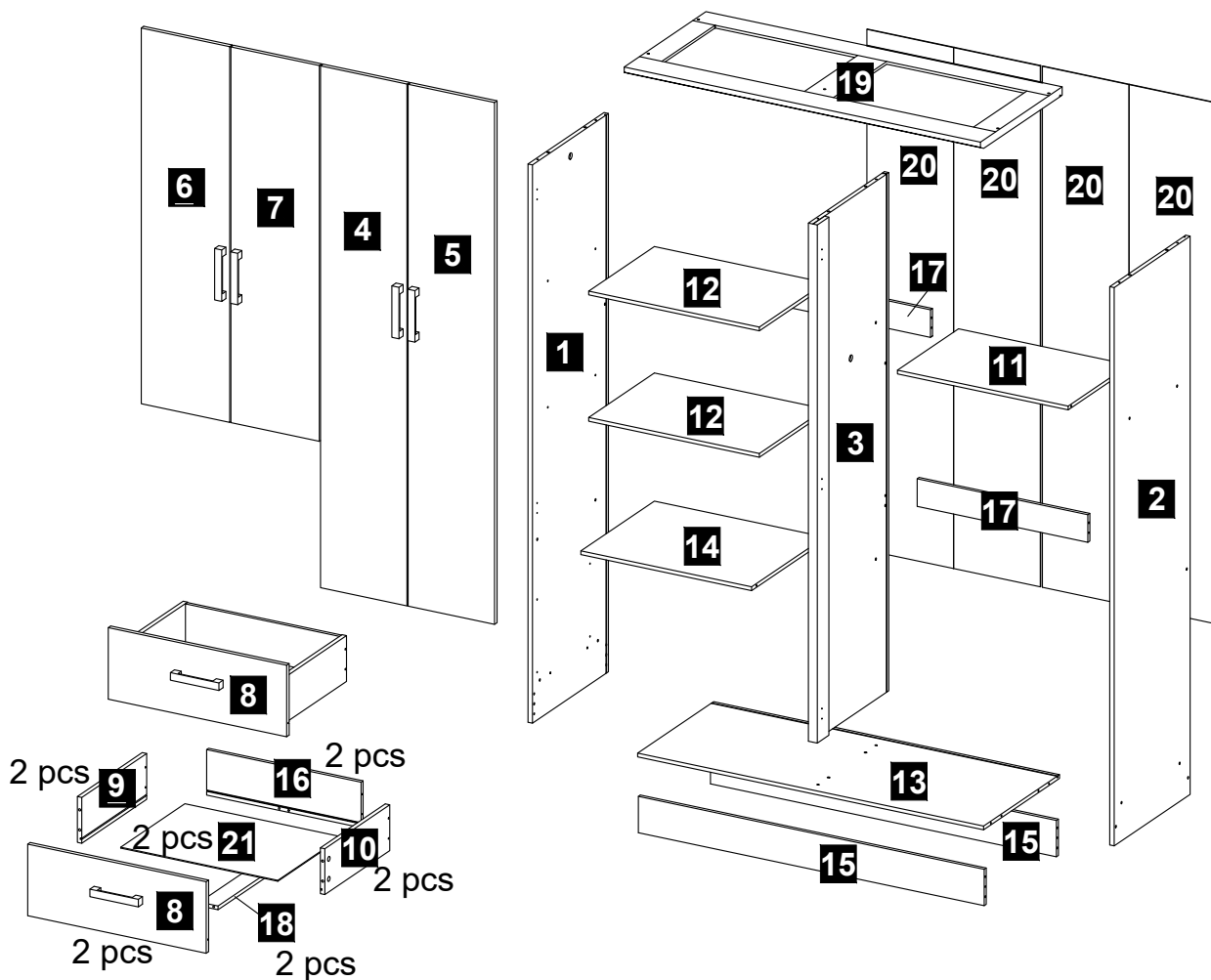

Parts List

1	Side Panel (L)	1 pc
2	Side Panel (R)	1 pc
3	Center Panel	1 pc
4	Big Door Panel (L)	1 pc
5	Big Door Panel (R)	1 pc
6	Door Panel (L)	1 pc
7	Door Panel (R)	1 pc
8	Drawer Front Panel	2 pcs
9	Drawer Side Panel (L)	2 pcs
10	Drawer Side Panel (R)	2 pcs
11	Small Shelf Panel (Fixed Shelf)	1 pc

12	Free Shelf Panel (Adjustable Shelf)	2 pcs
13	Base Panel	1 pc
14	Shelf Panel (Fixed Shelf)	1 pc
15	Crossbar Panel	2 pcs
16	Drawer Back Board	2 pcs
17	Small Crossbar	2 pcs
18	Drawer Crossbar	2 pcs
19	Top Panel	1 pc
20	Backboard	4 pcs
21	Drawer Bottom Panel	2 pcs

EACH PART IS LABELLED ACCORDING TO THE PARTS LIST



Before starting assembly
please verify if all parts and
hardware are included

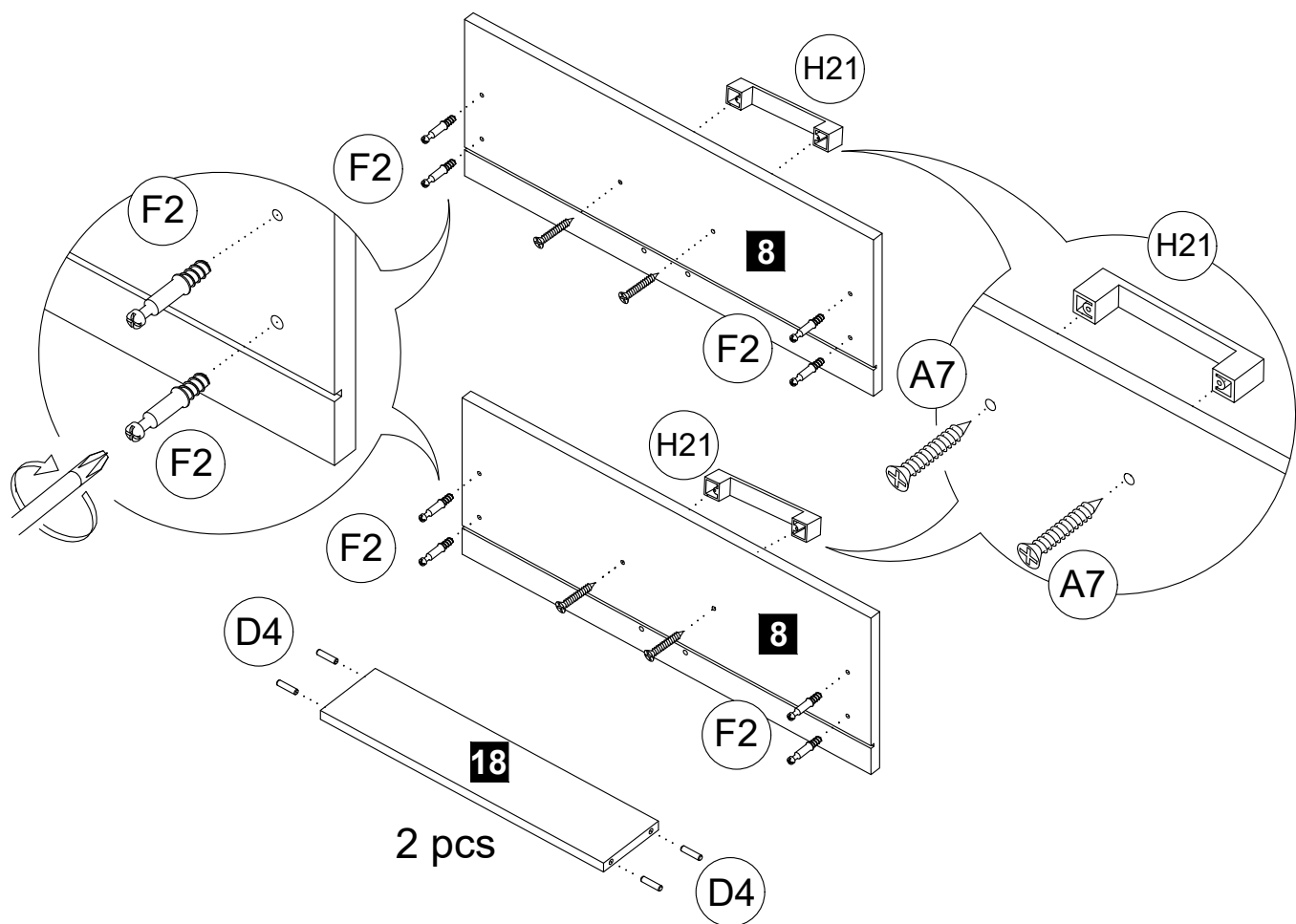

STEP 1

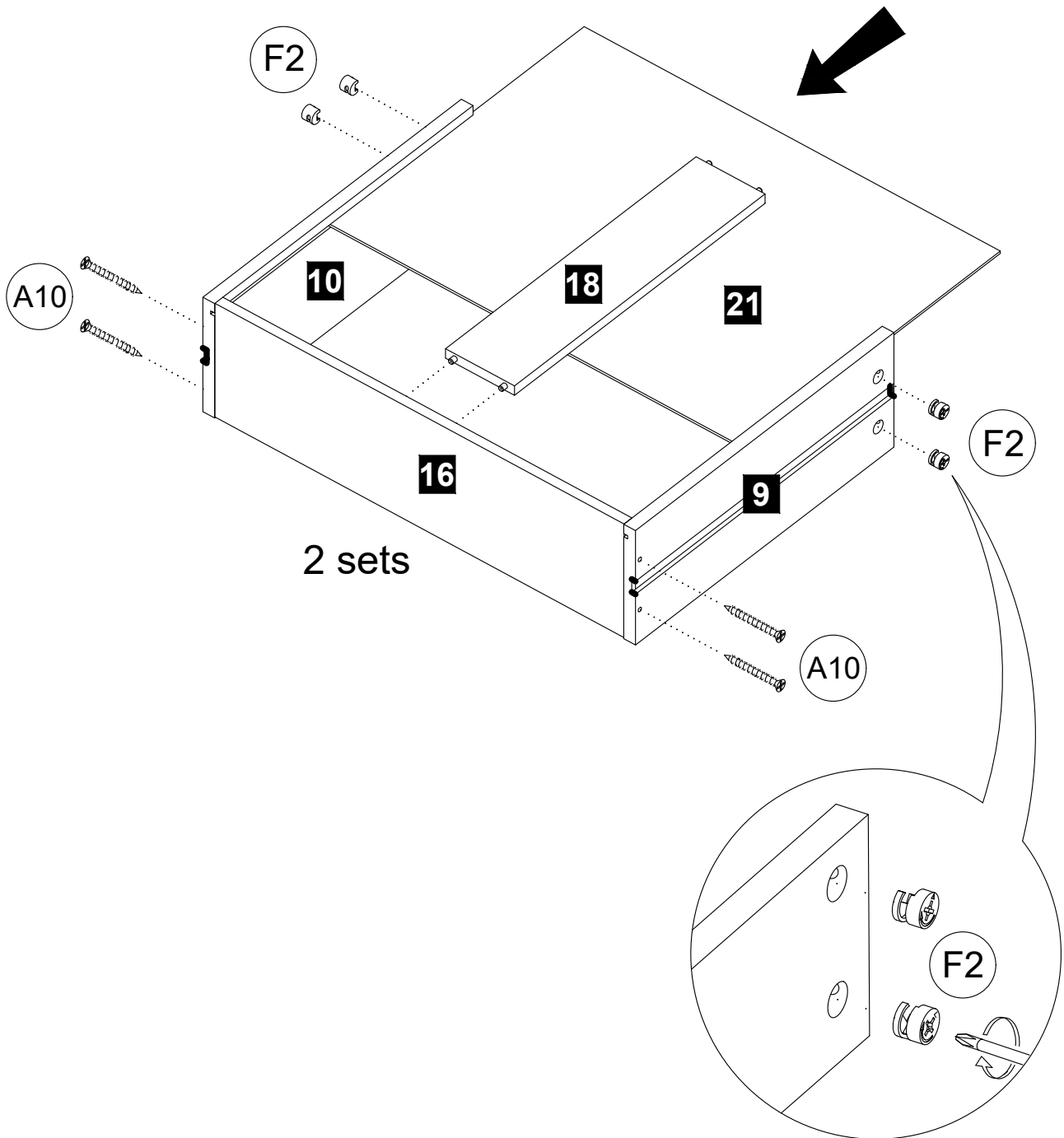

A7		Screw m4 x 30mm	4 pcs
D4		Wood Dowel 6 x 25mm	8 pcs
F2		Mini Fit 15mm	8 pcs
H21		Handle 128mm	2 pcs

STEP 2



A10		Screw m4 x 38mm	8 pcs
F2		Mini Fit 15mm	8 pcs

STEP 3

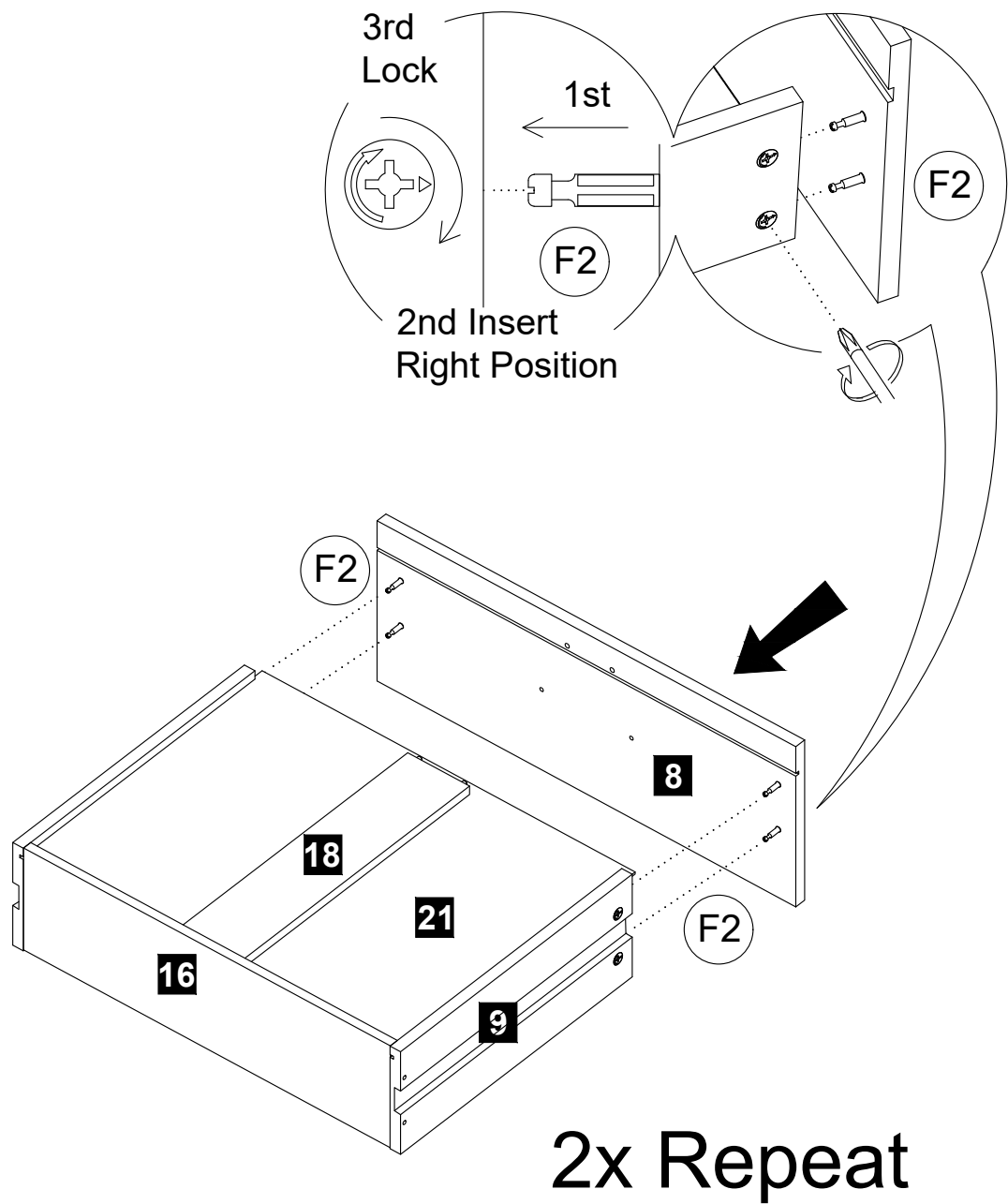

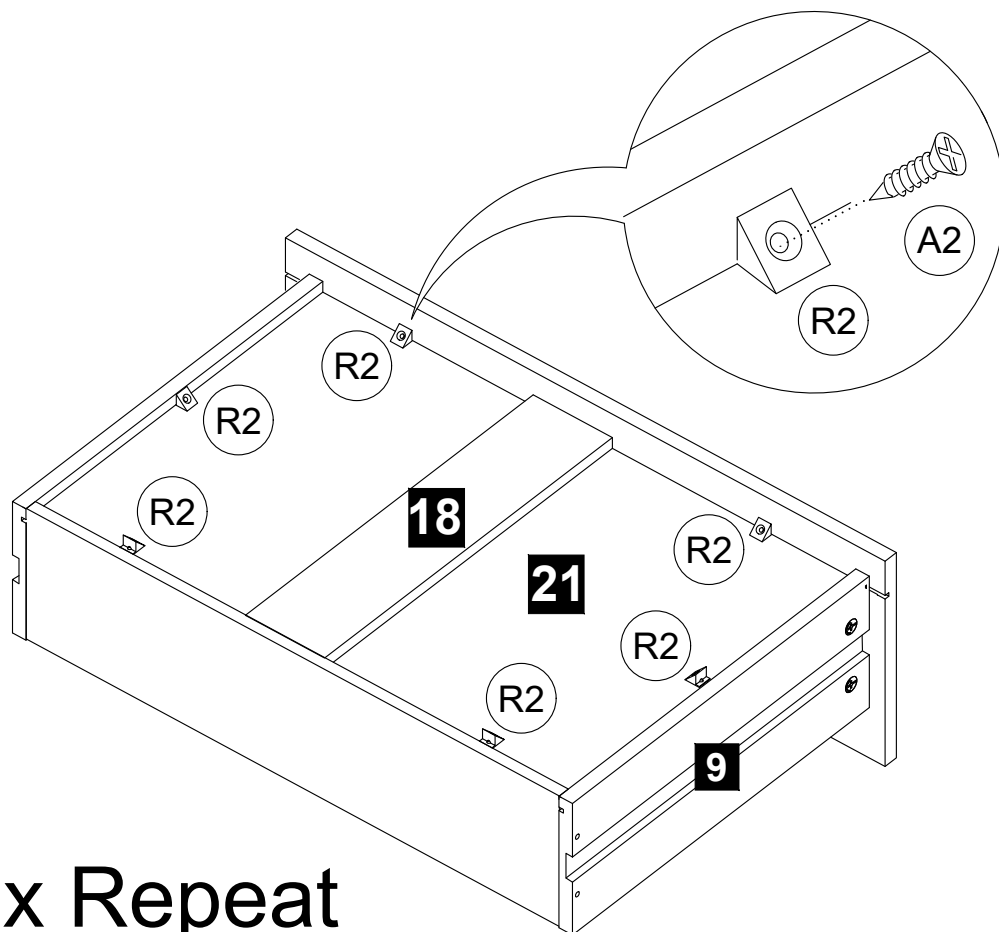

F2		Mini Fit 15mm	8 sets
----	-------------------------------------------------------------------------------------	---------------	--------

STEP 4





2x Repeat

A2		Screw m3.5 x 14mm	12 pcs
R2		Single Plastic Cap	12 pcs

STEP 5

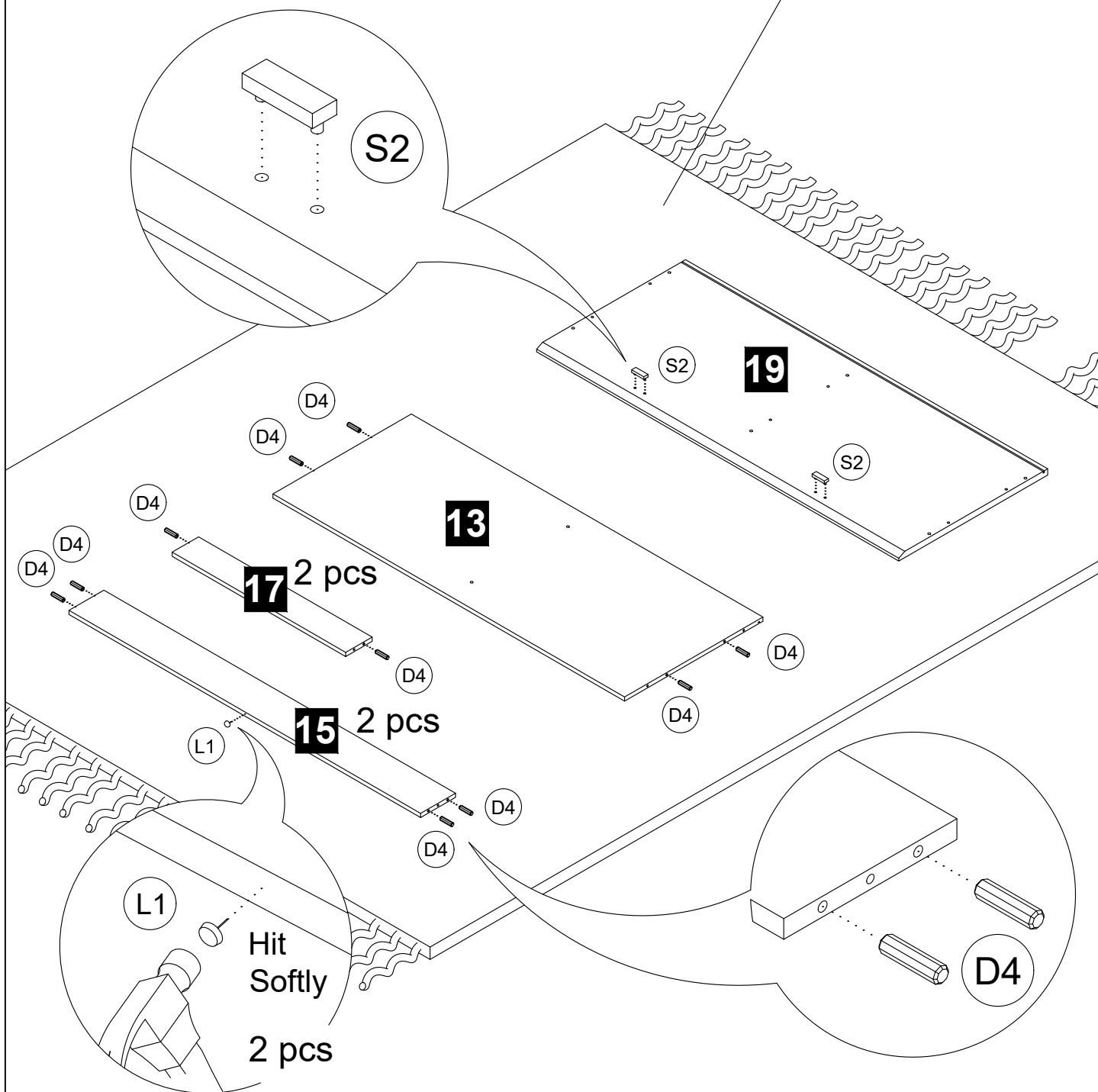
ATTENTION !
Clean Surface / Rug
before start assemble

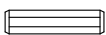

D4		Wood Dowel 6 x 25mm	16 pcs
L1		Leg Pin	2 pcs
S2		Door Stopper	2 pcs

STEP 6



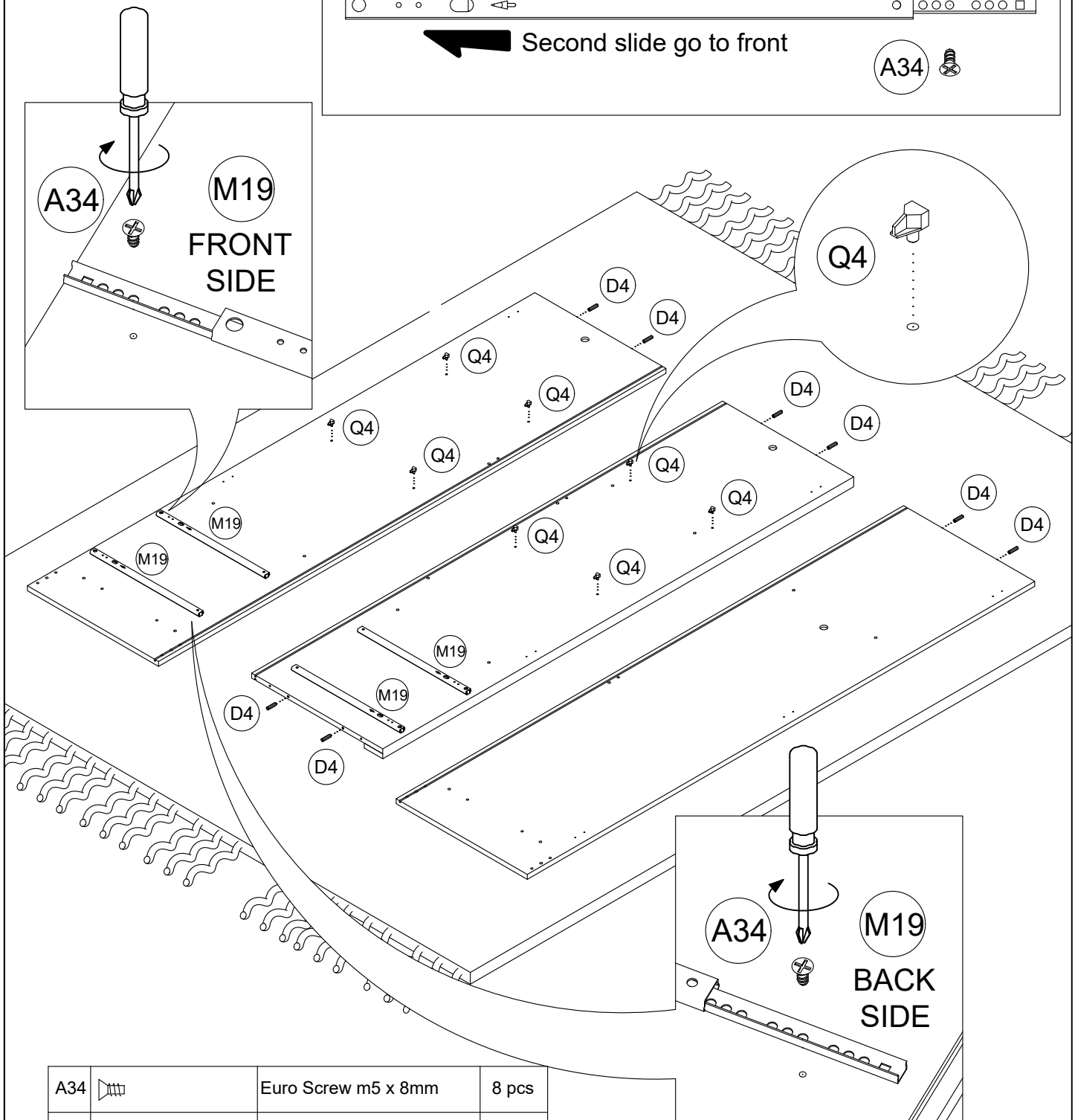
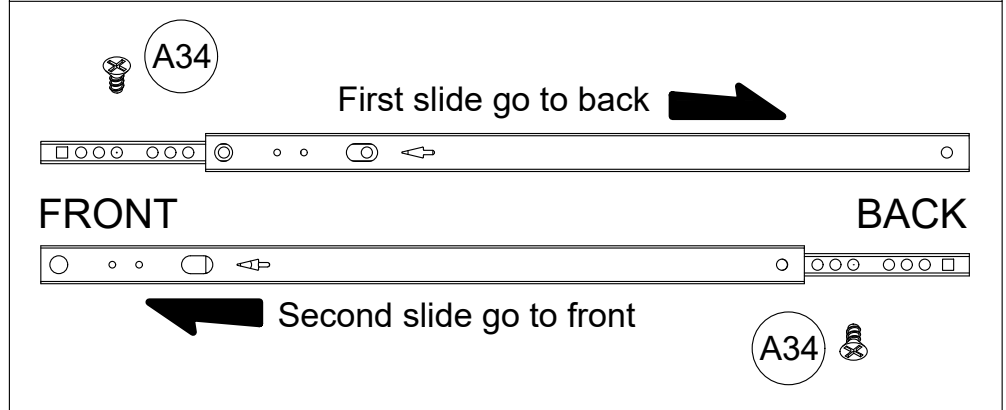

To Assemble the 2 Way Slide, Please follow step as below

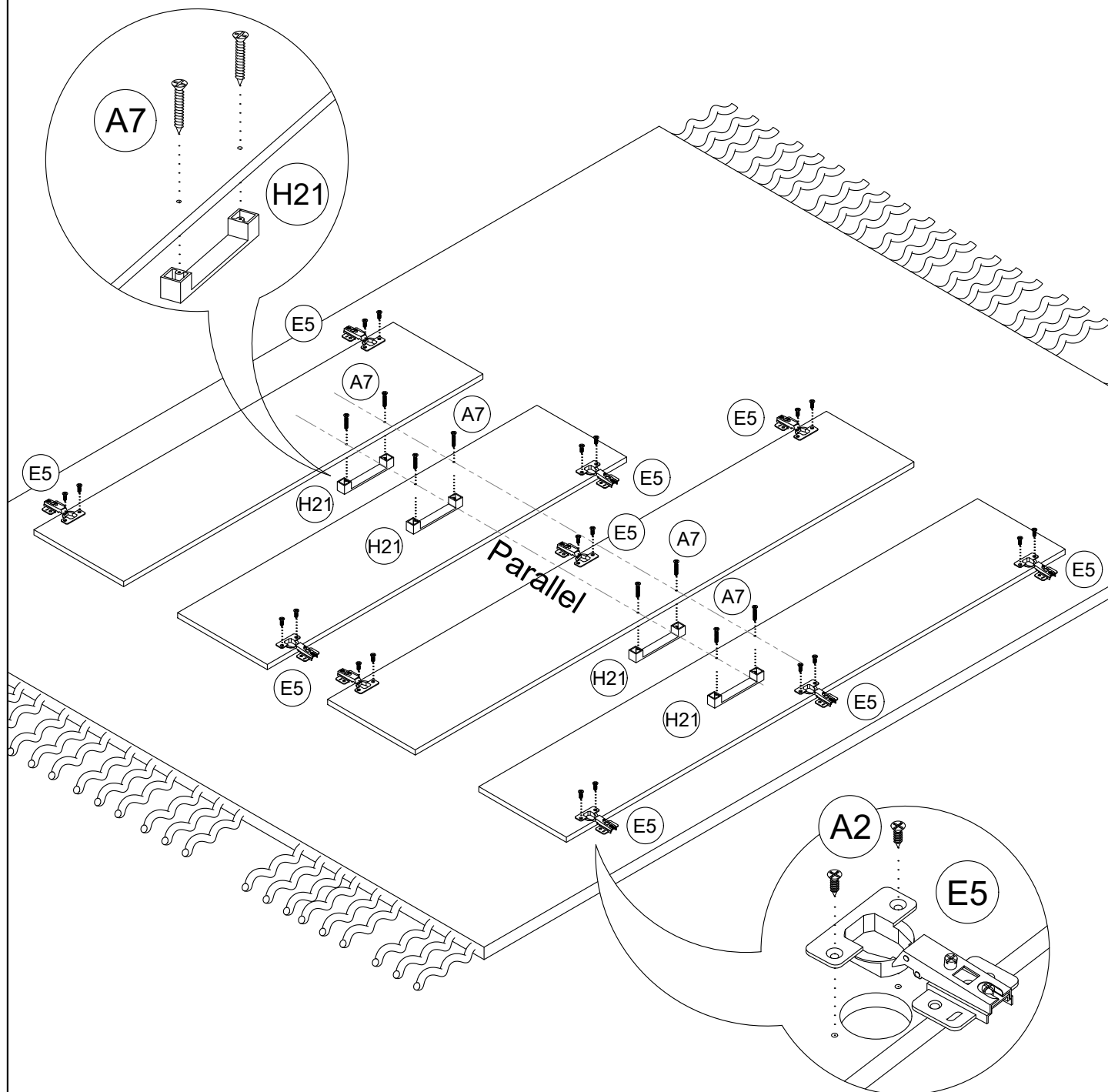

A34		Euro Screw m5 x 8mm	8 pcs
D4		Wood Dowel 6 x 25mm	8 pcs
M19		2 Way Slide_406mm	2 sets
Q4		Plastic Shelf Support with Steel Pin	8 pcs





STEP 7

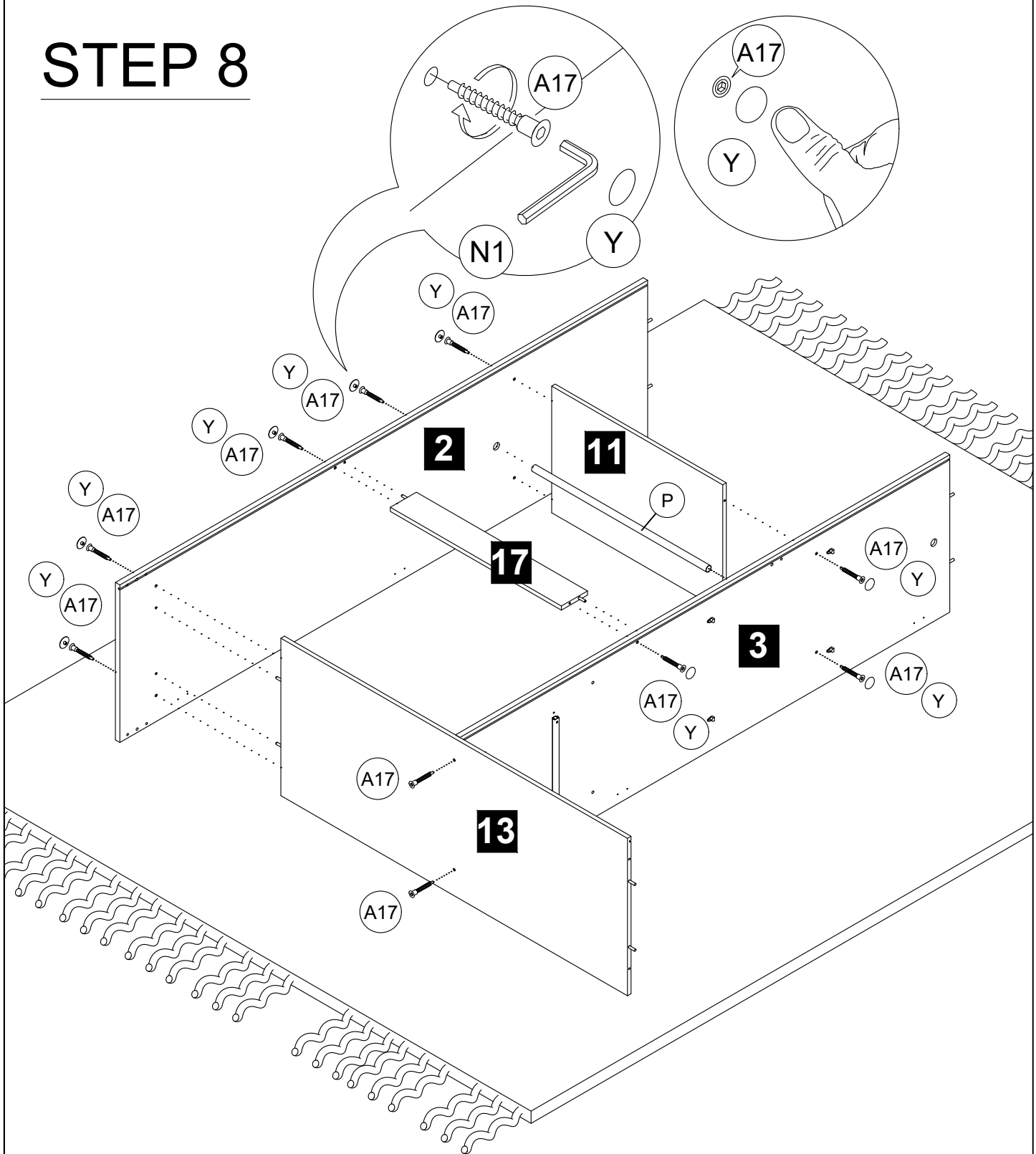

A2		Screw m3.5 x 14mm	20 pcs
A7		Screw m4 x 30mm	8 pcs
E5		Soft Closing Hinge 5/8	10 pcs
H21		Handle 128mm	4 pcs

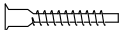

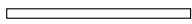

STEP 8

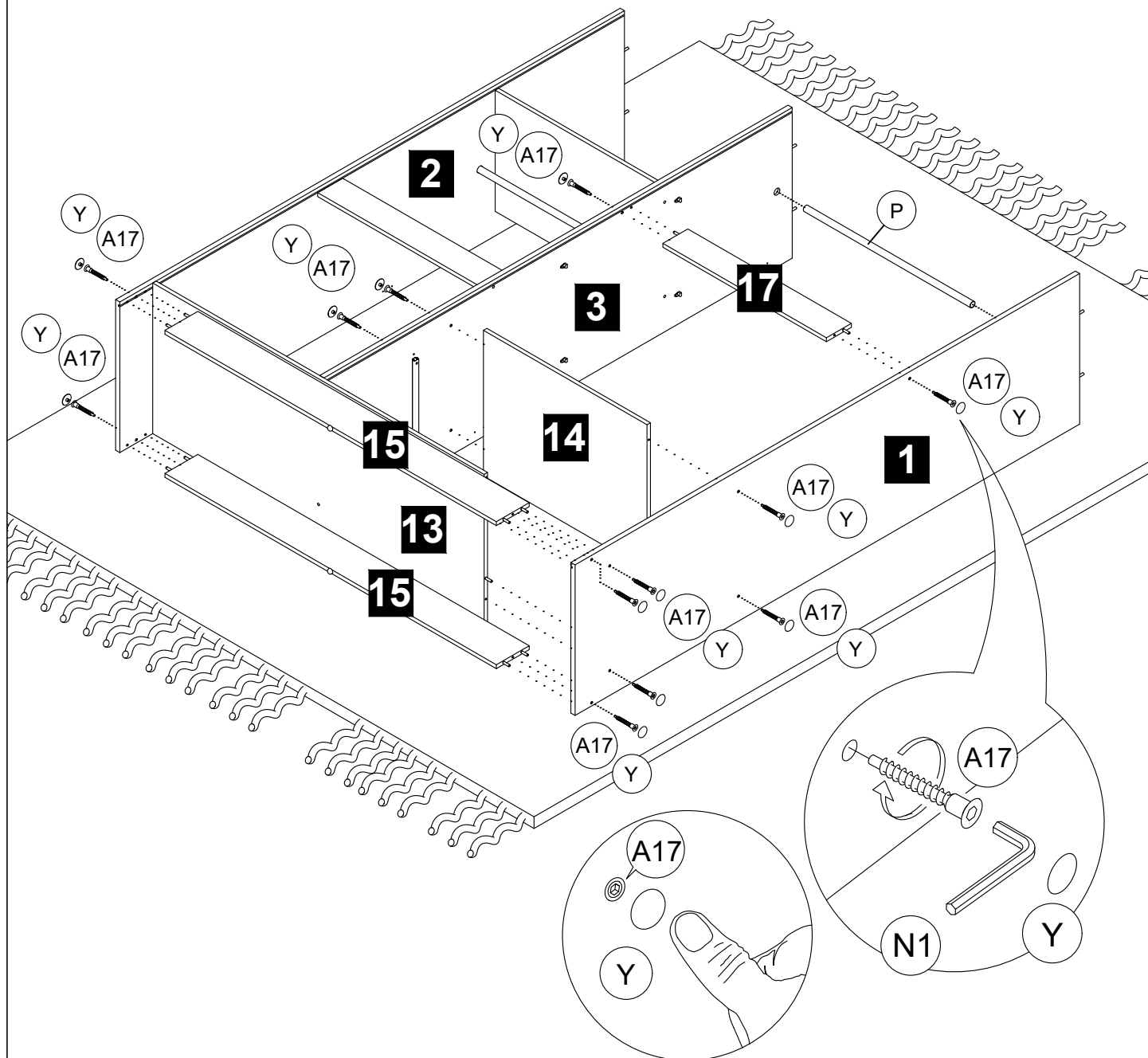

A17		Screw m6.3 x 40mm	10 pcs
N1		Allen Key	1 pc
P		Hanging Steel Pipe 18mm x 588mm	1 pc
Y		Crosshead Cover	8 pcs

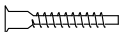
STEP 9



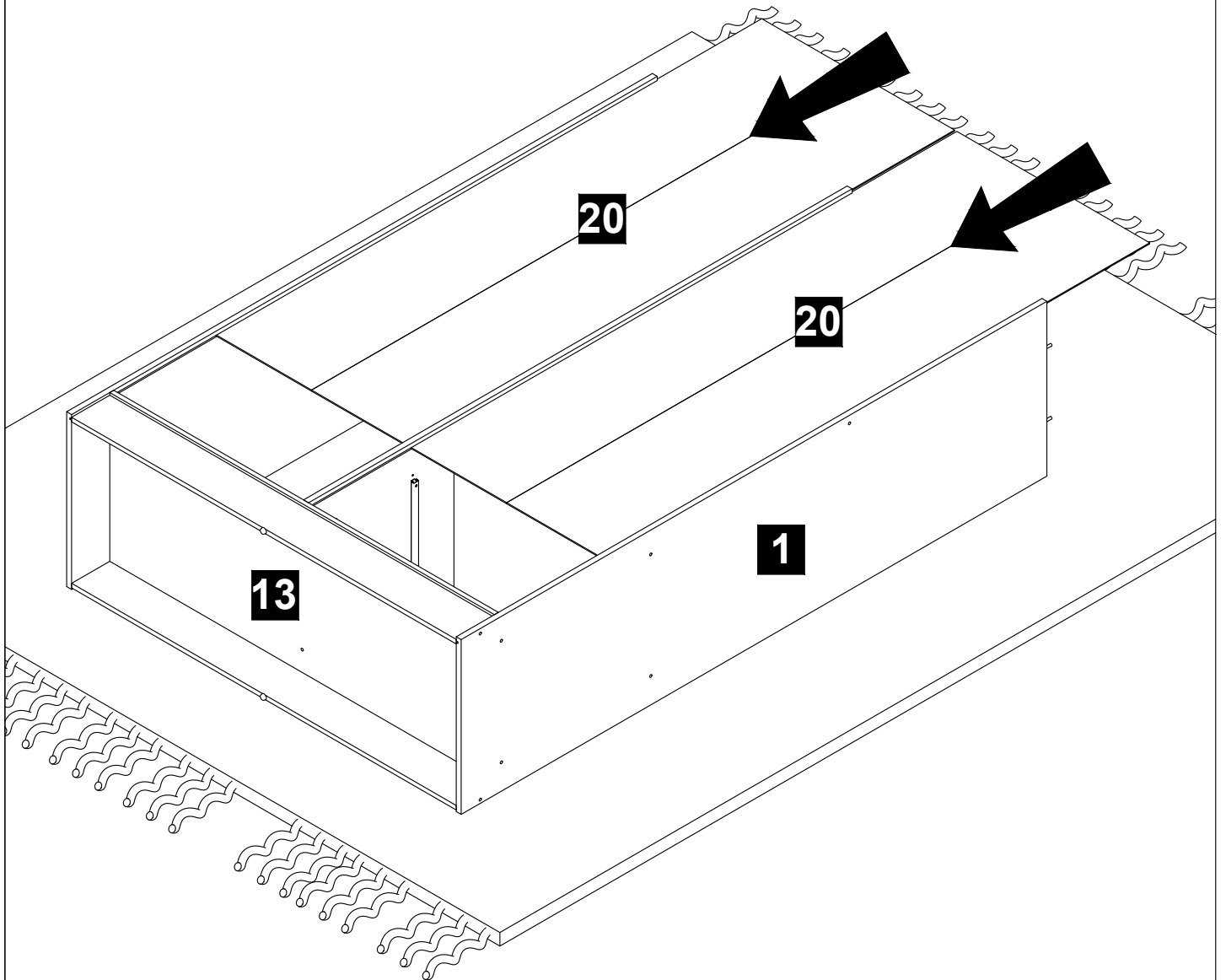

A17		Screw m6.3 x 40mm	12 pcs
N1		Allen Key	1 pc
P		Hanging Steel Pipe 18mm x 588mm	1 pc
Y		Crosshead Cover	12 pcs

STEP 10



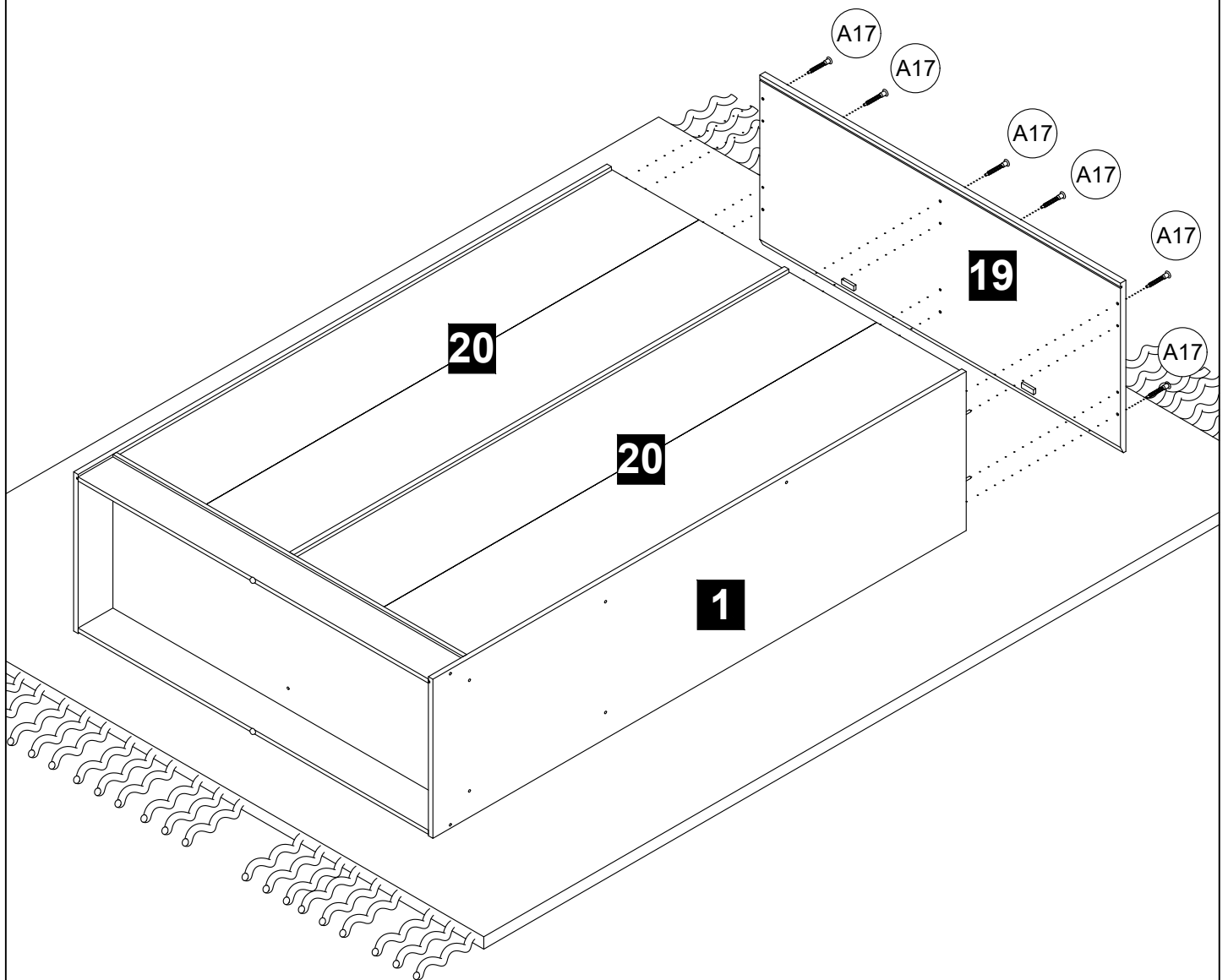

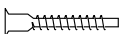

STEP 11

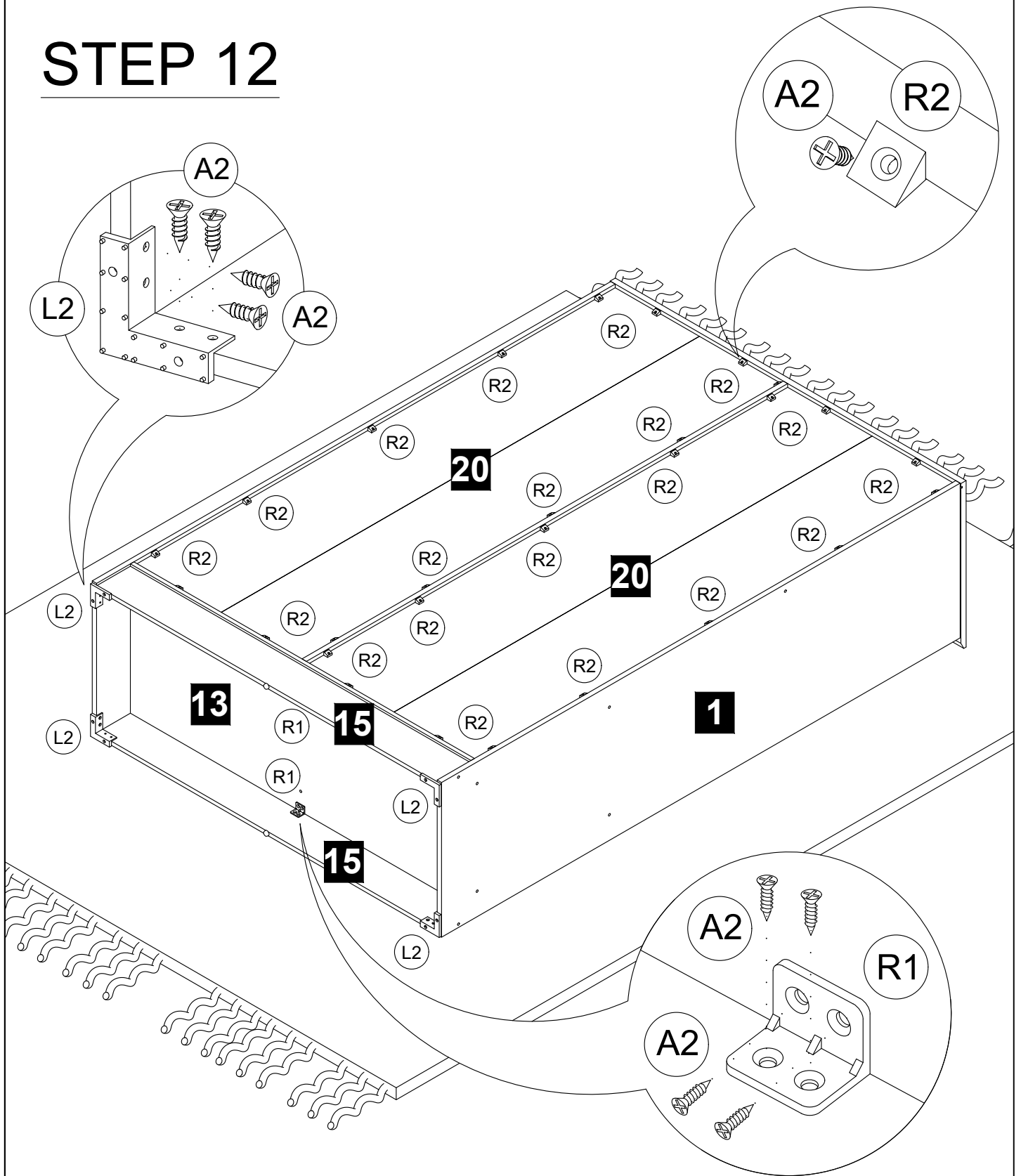

A17		Screw m6.3 x 40mm	6 pcs
N1		Allen Key	1 pc

STEP 12



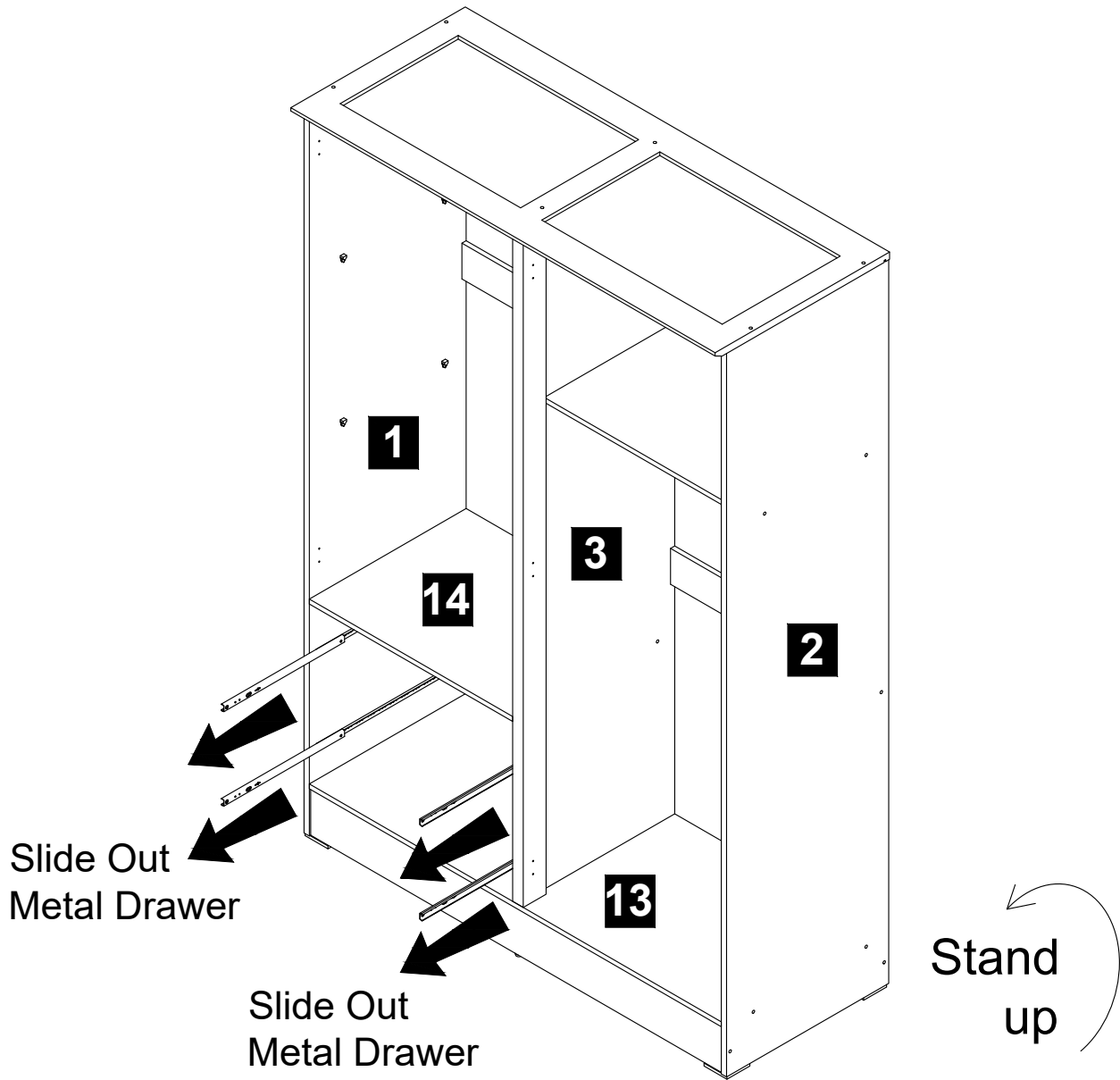

A2		Screw m3.5 x 14mm	52 pcs
L2		Plastic Leg L Shape	4 pcs
R1		L Bracket	2 pcs
R2		Single Plastic Cap	28 pcs

STEP 13

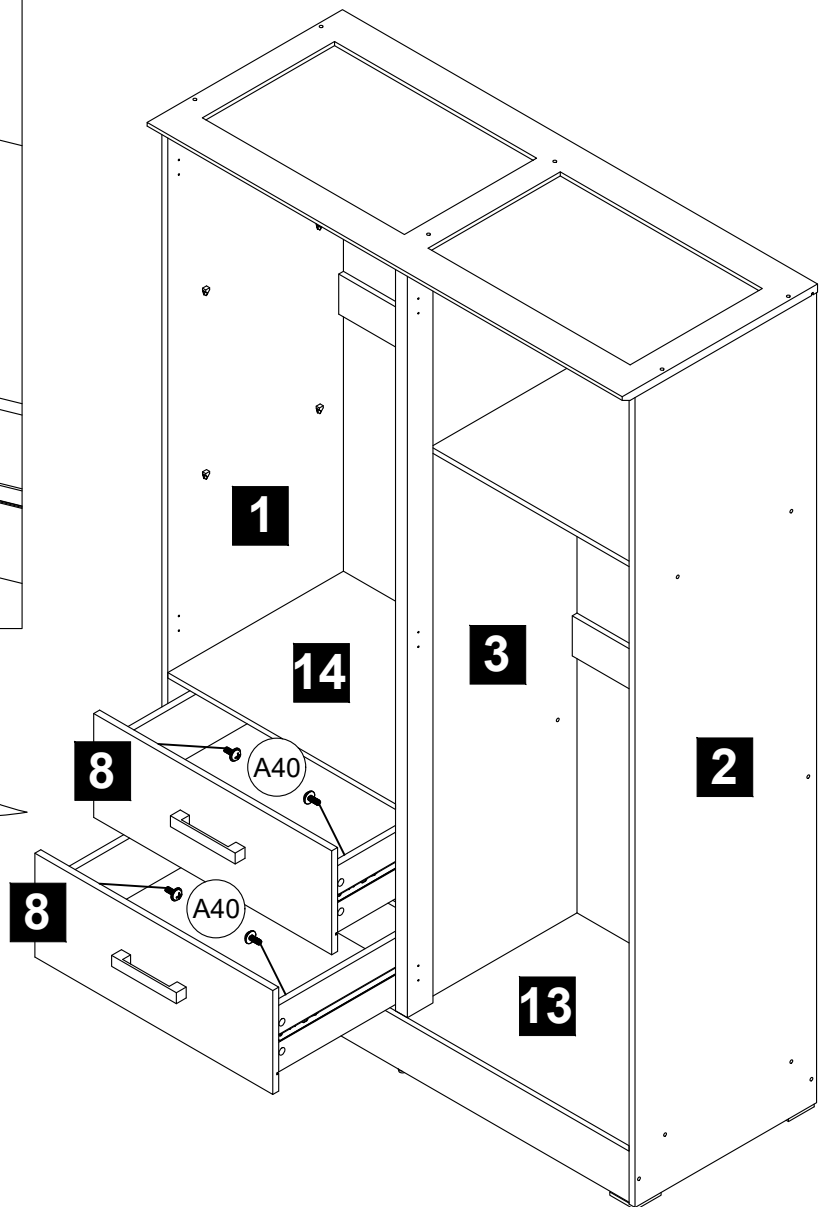
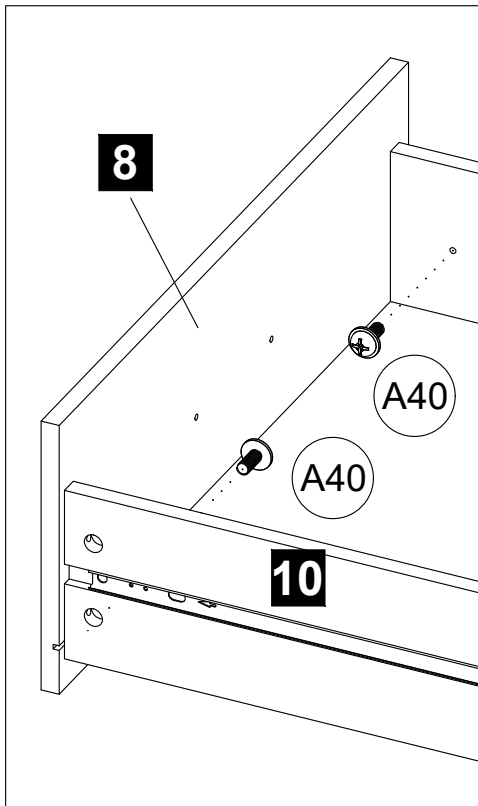

STEP 14



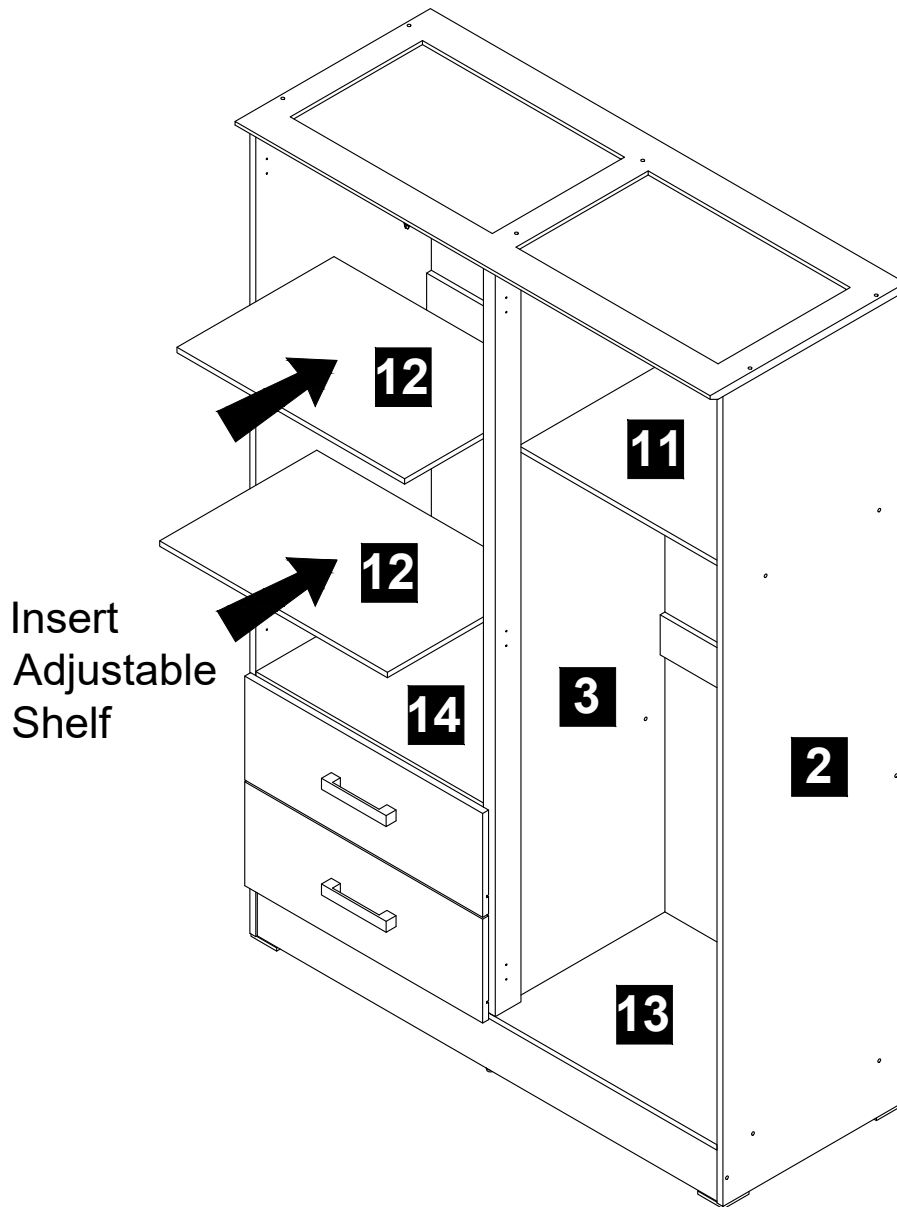

A40		TH Screw m4 x 10mm	4 pcs
-----	-------------------------------------------------------------------------------------	--------------------	-------

STEP 15

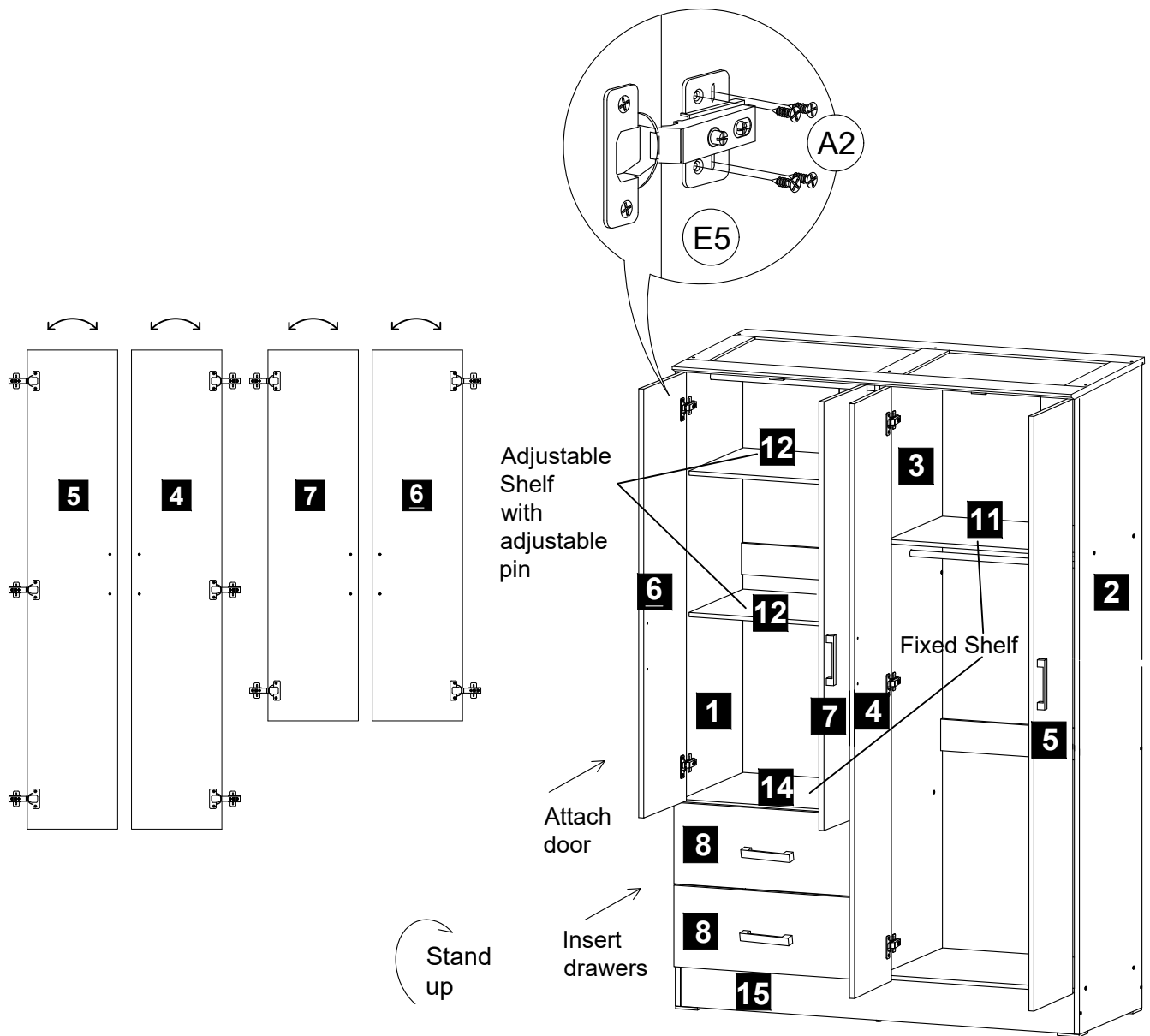

STEP 16



A2		Screw m3.5 x 14mm	40 pcs
E5		Soft Closing Hinges 5/8	10 pcs

DOOR ADJUSTMENT

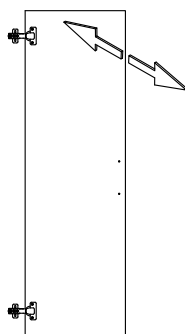
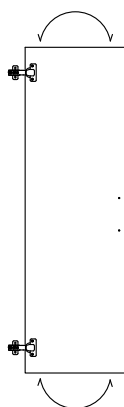
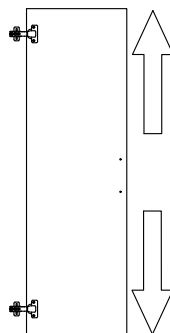
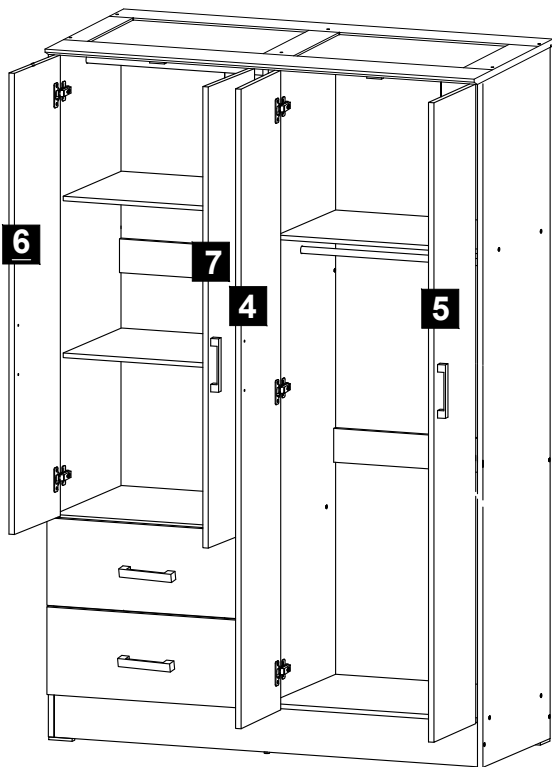

Up - Down

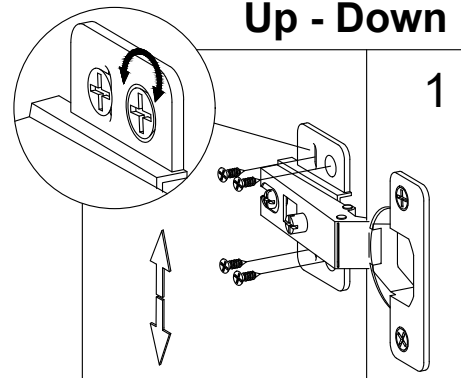

If the doors are not aligning move hinge up or down

Left - Right

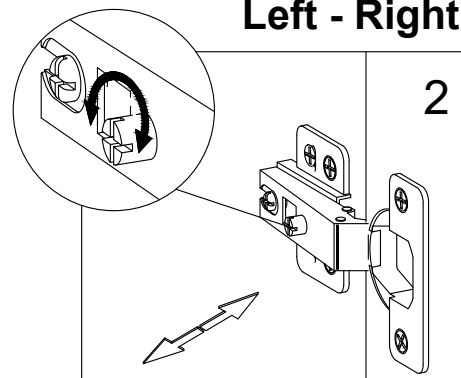

-If doors are over lapping each other or not parallel.
-If the gap between the doors is too large or too small.

In - Out

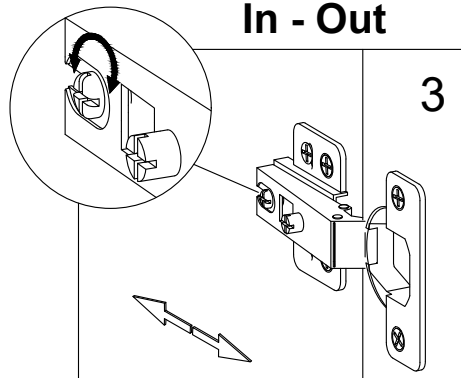

If the doors are rubbing against the sides of the closet move them away to increase the swing of the door.

INSTALLATION OF TIPOVER RESTRAINT KIT

The Tipover Restraint Kit is highly recommended for this piece of furniture.

(Please take this into extra consideration around young toddlers and children)

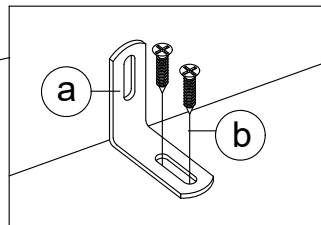
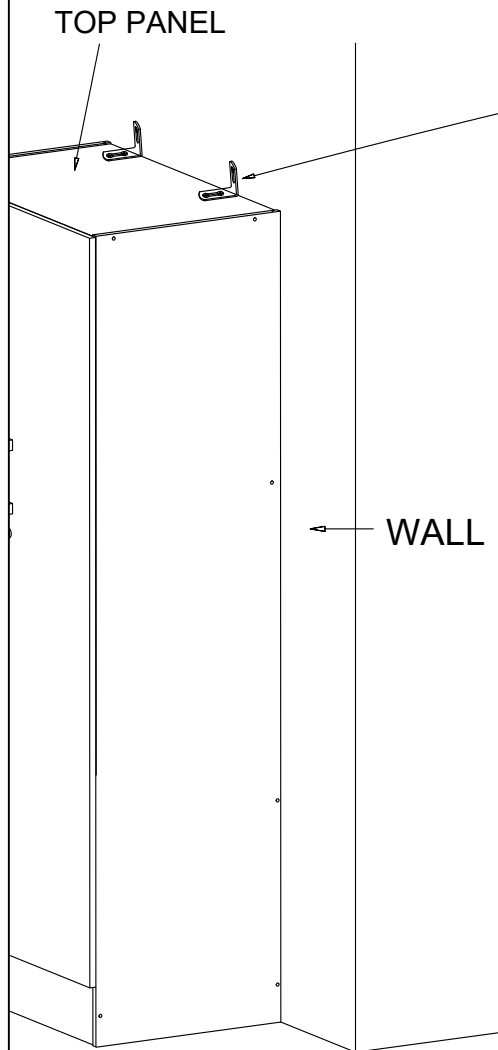

STEP 1:

- Attach the mounting bracket (a) to the top panel near the edge of the side of the unit.
- Screw (b) through the two holes of (a).

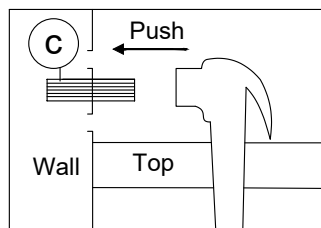

STEP 2:

- Insert the wall plug (d) into the wall behind the unit.

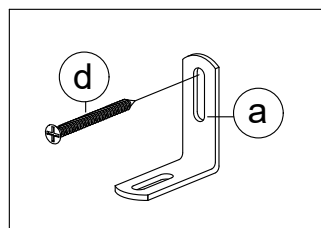

STEP 3:

- Attach to the mounting bracket (a) to the wall plug (c) through the hole by using (d).

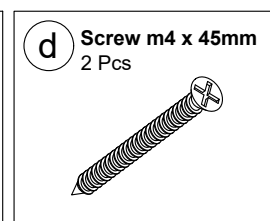
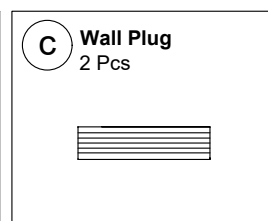
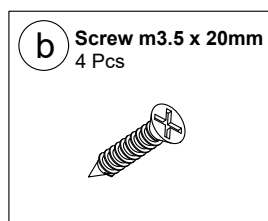
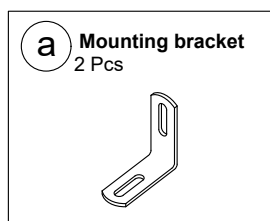

AH CHAI ENTERPRISE SDN BHD
LOT 17334, LORONG ASAS JAYA 3,
KWS PERINDUSTRIAN RINGAN ASAS JAYA,
PERMATANG TINGGI,
14000 BUKIT MERTAJAM, PENANG.
Manufacture Date: 9/12/2023

Troubleshooting

- If the drawers are overlapping each other - **Solution:** The metal slides are placed upside down, please refer to the instruction manual.
- If the doors are overlapping each other - **Solution:** make sure the correct hinges are placed on the right door refer to the hinge assembly step on the manual.
- If the gap between the doors is too large or too small, the doors are overlapping each other, not parallel, or rubbing against the sides of the closet - **Solution:** See the page for " Door Adjustment. "

THANK YOU

We hope you enjoy your new purchase.

We have personally inspected this product.

In the event that you need any additional help for any reason,

Please do not hesitate to contact us.

Thank you