

# ASSEMBLY INSTRUCTIONS

## IMPORTANT NOTE

**\*\*PLACE ALL PARTS ON A CLEAN AND SMOOTH SURFACE SUCH AS A RUG OR CARPET TO AVOID THE PARTS FROM BEING SCRATCHED**

**\*\*BEFORE YOU BEGIN, KINDLY FOLLOW THE ASSEMBLY INSTRUCTIONS STEP BY STEP**



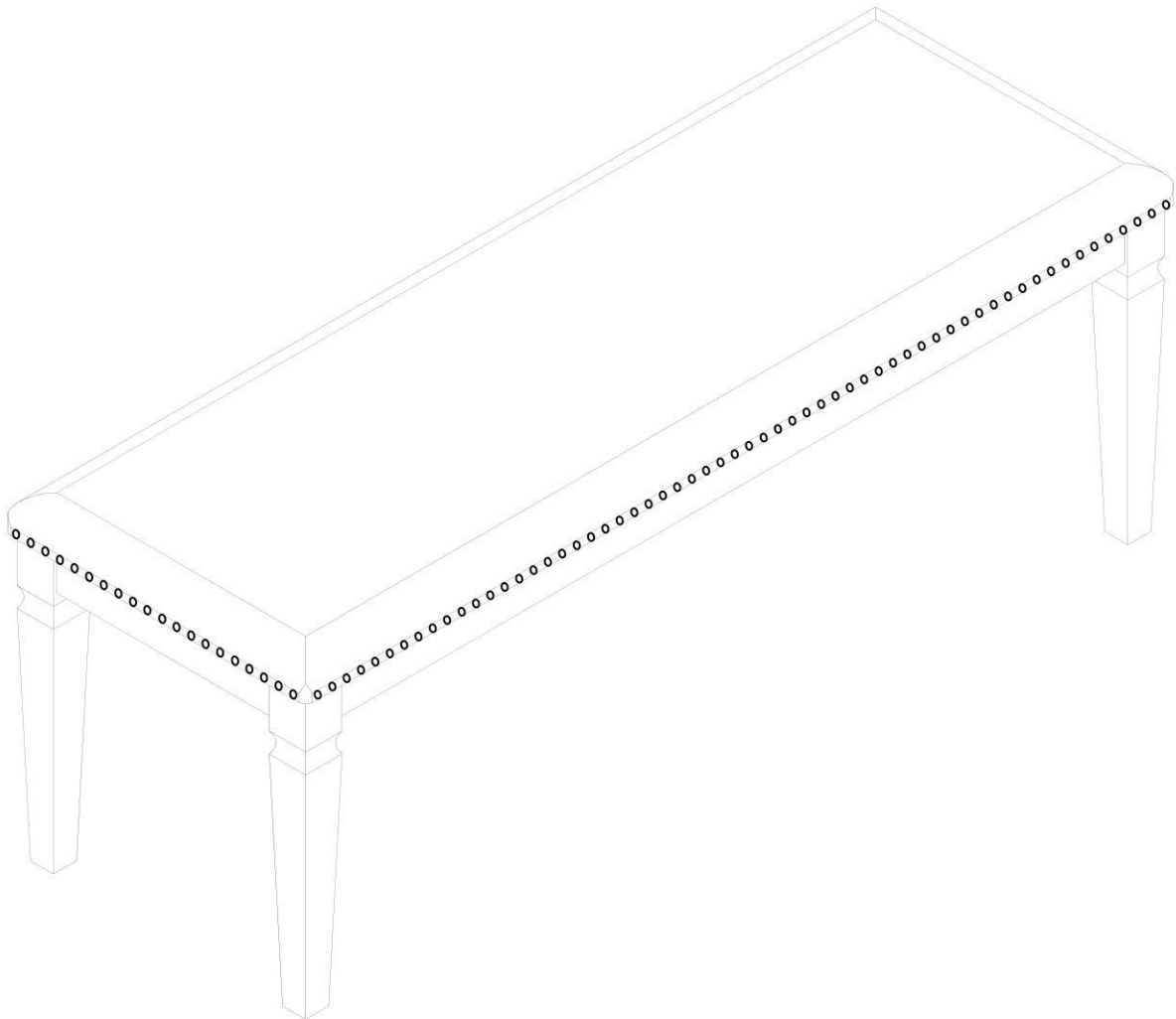



**\*\*DO NOT TIGHTEN ALL SCREWS AND BOLTS UNTIL THE BENCH IS FULLY SET-UP**

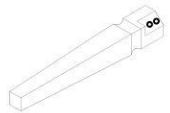

**PLEASE DO NOT RETURN PRODUCT TO THE STORE**

# ASSEMBLY INSTRUCTIONS

## CARTONS ONLY ONE / HARDWARE LIST

PART LISTS				HARDWARE LIST			
NO	DESCRIPTION	SKETCH	Q'TY	NO	DESCRIPTION	SKETCH	Q'TY
A	SEAT CUSHION		1 PC	1	<b>BOLT</b> Ø5/16*50mm		8 PCS
B	LEGS		4 PCS	2	<b>WASHER</b> Ø5/16"*19mm		8 PCS
				3	<b>SPRING WASHER</b> Ø5/16"*11mm		8 PCS
				4	<b>ALLEN KEY</b> M4*60mm		1 PC

### STEP 1

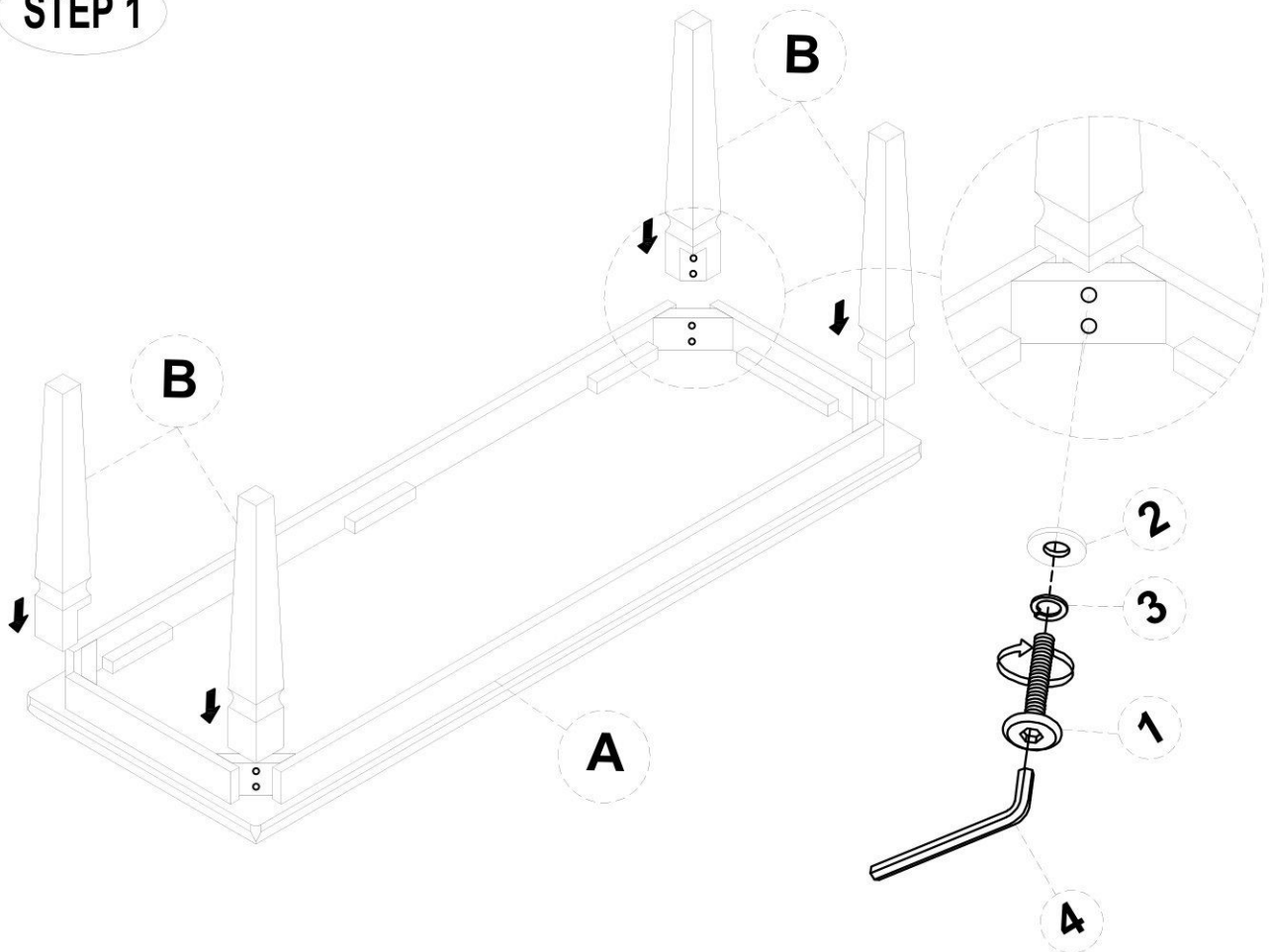

# ASSEMBLY INSTRUCTIONS

**COMPLETE**

