

ASSEMBLY INSTRUCTIONS

5-DRAWER CHEST WITH 2 SETS MODULAR STORAGE PANELS

A 5-Drawer Chest

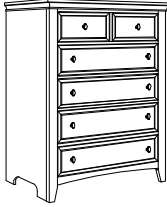

1 pc

B Modular Storage Panel
(Big)
(In the bottom drawer
of Chest)



6 pcs

C Modular Storage Panel
(Small)
(In the bottom drawer
of Chest)



8 pcs

D Bracket (Anti-Tip Kit)
14mm x 14mm x 14mm

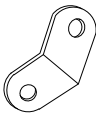

2 pcs

E Tie Wrap (Anti-Tip Kit)

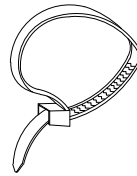

1 pc

F Pan Head CB Screw
(Anti-Tip Kit)
M4 x 50mm



1 pc

G Pan Head CB Screw
(Anti-Tip Kit)
M4 x 16mm



1 pc



This page lists all the contents included in the box. Please take the time to identify the hardware as well as the individual components to this product. As you unpack and prepare for assembly, place the contents on a carpeted or padded area to protect them from damage.

IMPORTANT NOTE :

1. Do not tighten all screws / bolts until all completely assembled.
2. Keep all hardware parts out of reach of children.

1 Open the bottom drawer and find the carton containing the modular storage panels.

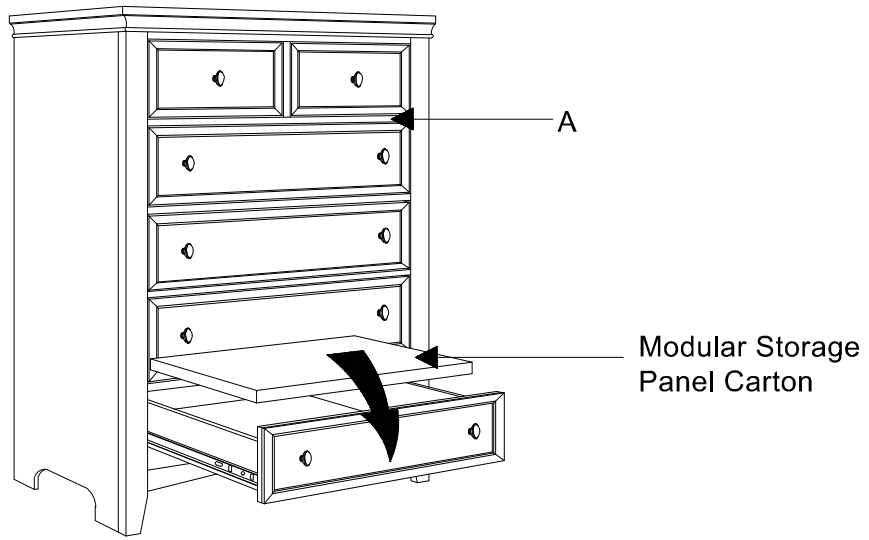

2 Fully extend the drawers, then insert the Modular Storage Panel (B & C) as shown in the diagram below.

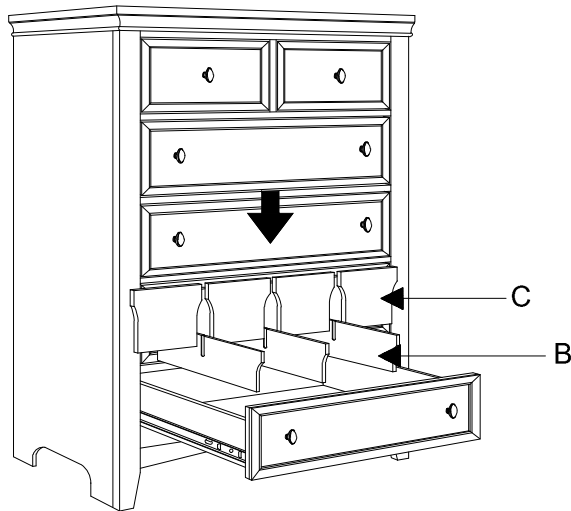

Drawer Divider Options

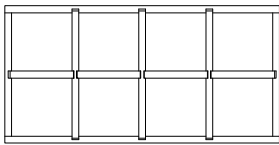

Optional 1

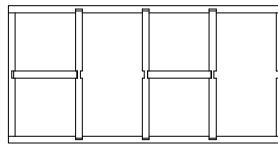

Optional 2

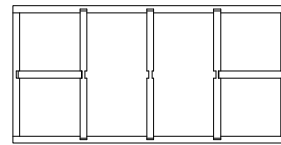

Optional 3

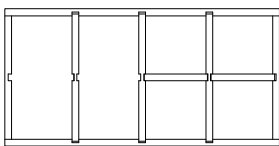

Optional 4

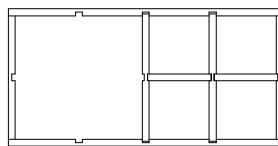

Optional 5

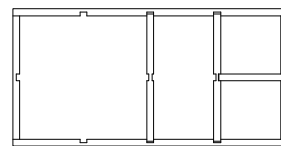

Optional 6

3

Attach the Anti-Tip Kit (D), (E), (F) and (G) to the Chest (A) and wall as shown in the diagram below.

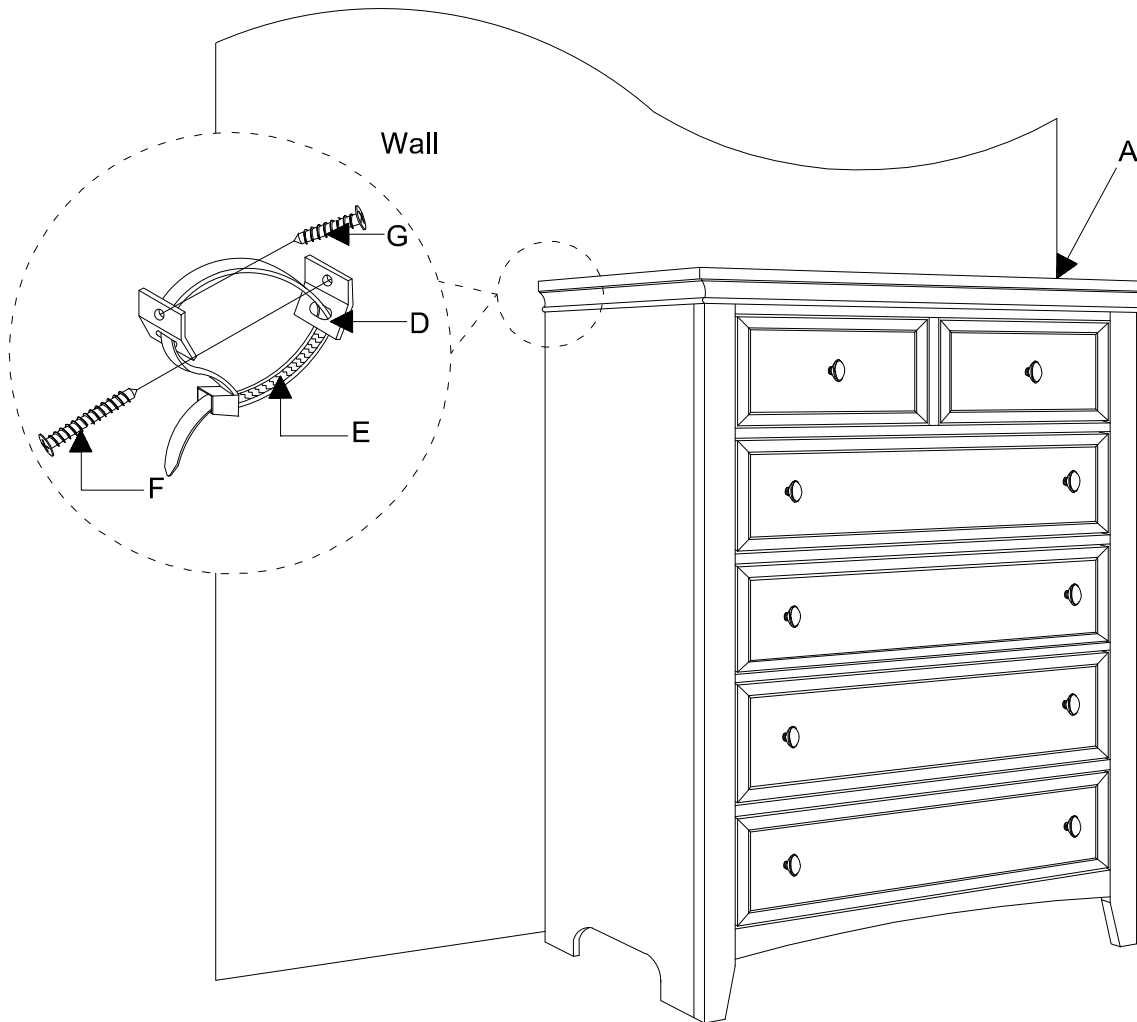

CLEANING & CARE

Treat surfaces with care. Surfaces are resistant to scratches but are not scratch resistant. Clean surfaces with a dry or damp soft cloth. Do not use abrasive cleaners. Hardware may loosen over time. Periodically check that all connections are tight.