

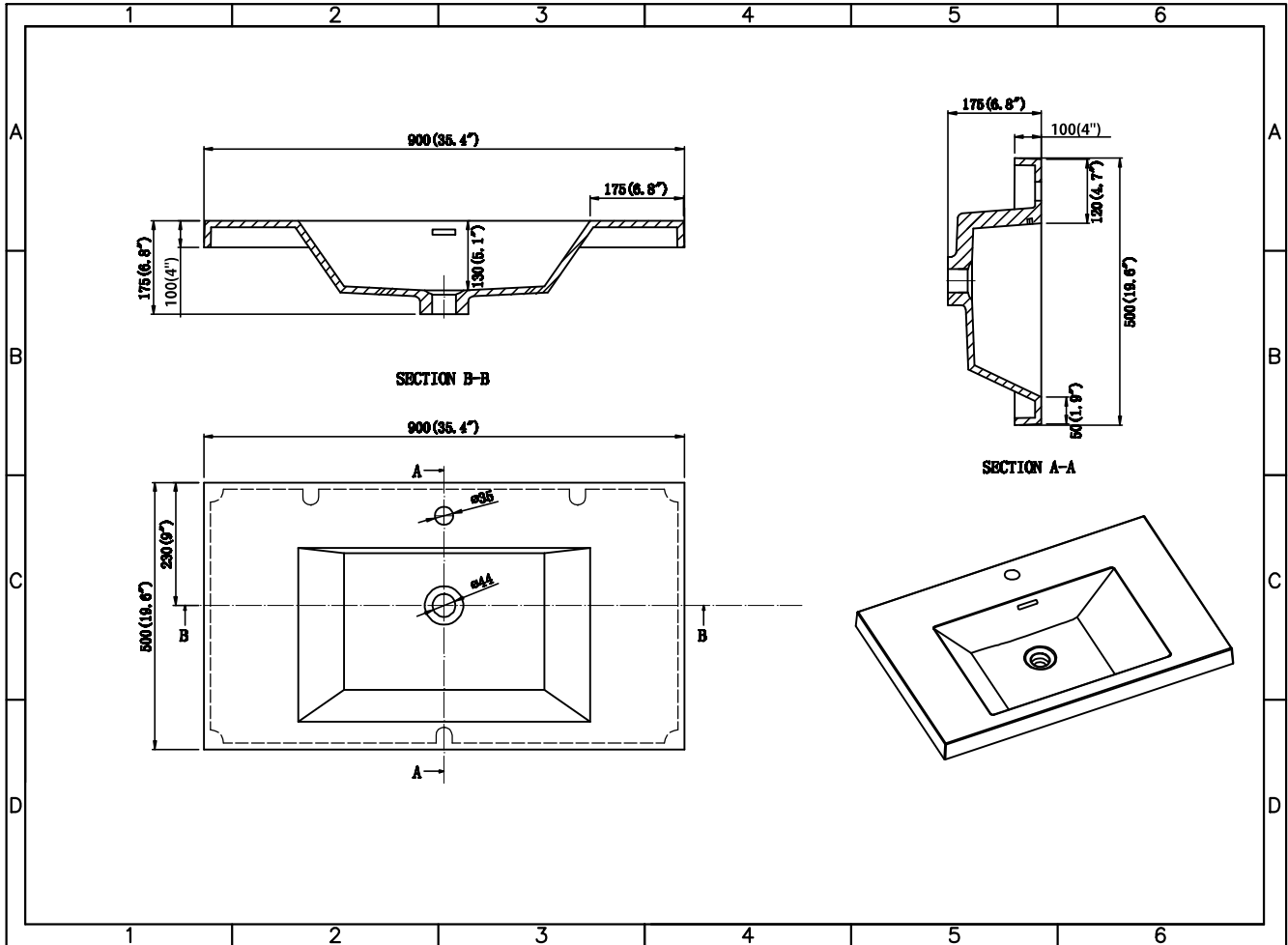









# Dimensions



**BASIN DIMENSIONS (inch)**

Sink Size	Length (from left to right)	Width (from front to back)	Depth (from top to bottom)	Distance between the side of the <b>faucet hole</b> and the <b>back edge of the basin</b>	Distance between the center of the <b>faucet hole</b> and the <b>back edge of the top</b>	Distance between the center of the <b>drain hole</b> and the <b>back edge of the top</b>	Distance between the <b>center of the faucet/drain hole</b> and <b>closer side edge of the top</b>	Distance between <b>two faucet/drain holes</b> (center to center)	Distance between <b>the two basins</b>
									
<b>24" SINK</b>	19	13	5	1.75	2.5	9.25	12	/	/
<b>30" SINK</b>	21.25	13	5	1.75	2.5	9.25	15	/	/
<b>36" SINK</b>	21.25	13	5	1.75	2.5	9.25	17.75	/	/
<b>42" SINK</b>	21.25	13	5	1.75	2.5	9.25	21.25	/	/
<b>48" SINK</b>	24	13	5	1.75	2.5	9.25	23.5	/	/
<b>60"S SINK</b>	24	13	5	1.75	2.5	9.25	29.5	/	/
<b>60"D SINK</b>	21.25	13	5	1.75	2.5	9.25	14.75	29.5	8
<b>72"D SINK</b>	21.25	13	5	1.75	2.5	9.25	17.75	35.5	14
<b>84"D SINK</b>	24.25	13	5	1.75	2.5	9.25	21	41.5	17.5
				<b>Faucet Hole: <math>\phi</math> 1.35</b>	<b>Drain Hole: <math>\phi</math> 1.75</b>				