

ASSEMBLY INSTRUCTIONS

TOOLS REQUIRED

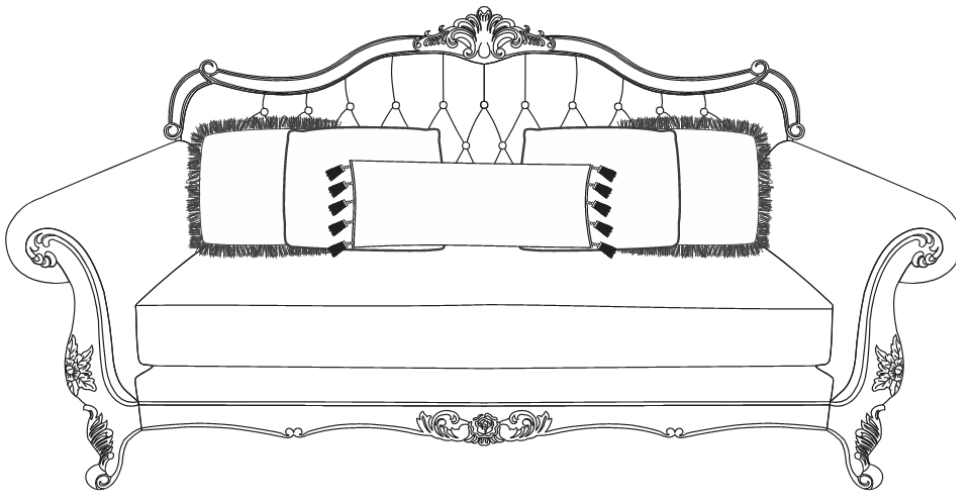

2 - People



ASSEMBLY RATING



EASY → DIFFICULT

The Assembly Rating is a 5-point system showing the level of effort needed to assemble a specific product.



CHECK BEFORE STARTING

Are you missing anything?

Double-check all parts, hardware and accessories listed are all accounted for.

Check out our Quick Tips!

We recommend reviewing the pre-assembly handouts. Even experts need a refresher now and then!

Should we send any replacements?

Are there any irregularities or flaws in the parts? We can send replacements!

Prep Time!

Please review the assembly instructions and all diagrams prior to assembling.

PRE ASSEMBLY INTRODUCTION

We understand building ready-to-assemble furniture can be a challenging experience for some. To help avoid confusion, we have provided some helpful tips that may speed up the process.



Teamwork

ALWAYS have at least two people to help with transporting and assembling the product to avoid potential injury and/or damage.



Suitable Location

Assembling near the area of the intended location is highly recommended.



Sufficient Space

Make sure you have enough space to move around during the assembly.



Avoid Scratches

Use cardboard, blankets or a carpeted area while assembling furniture to prevent to prevent scratches and damages.



Flat Surface

Make sure the furniture rests on a flat and level surface with each leg evenly touching the floor.

ASSEMBLY AND CARE ADVICE



FAILURE TO FOLLOW THE GUIDELINES BELOW MAY RESULT IN INJURY AND/OR PROPERTY DAMAGE.



Position each part correctly and insert screws or bolts into their respective holes.



Turn clockwise to tighten and only tighten when step is completed or when instructed to do so.



Use the appropriate hand tools or power tools for assembly. Select steps, such as tightening screws and/or bolts, may require hand tools to avoid causing damage during assembly.



Save the instructions and store any supplied tools for later maintenance.



After two weeks, check and tighten any loose hardware and repeat again every six months thereafter.

IT IS THE USER'S RESPONSIBILITY TO MAINTAIN THE FURNITURE. THE HARDWARE MAY LOOSEN OVER TIME AND MAY CAUSE THE FURNITURE TO BE WOBBLY AND UNABLE TO SUPPORT ITS INTENDED WEIGHT CAPACITY. THIS MAY LEAD TO COLLAPSE AND MAY CAUSE SERIOUS INJURY.









ASSEMBLY INSTRUCTIONS

Thank you for purchasing this quality product. Be sure to check all packing materials carefully for small parts, which may have come loose inside the carton during shipment. Identify and count all items and compare with the PARTS LIST and/or HARDWARE LIST shown below.



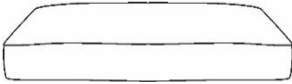

CAUTION: Read the instructions carefully before assembly.

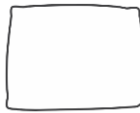
1. We recommend that you assemble this product with the assistance of another person to eliminate damage to the product during assembly.
2. When you want to reposition the product, please always "LIFT & MOVE".

PARTS LIST

NO	DESCRIPTION	SKETCH	Q'TY (PCS)
A	SEAT FRAME		1
B	LEFT SIDE FACING (LSF) ARM		1
C	RIGHT SIDE FACING (RSF) ARM		1
D	BACKREST		1
E	SEAT CUSHION		1
F	MIDDLE LEG		1
G	SQUARE PILLOW		2
H	KIDNEY PILLOW		1
I	SOLID PILLOW		2

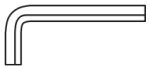
HARDWARE LIST

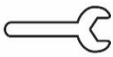
NO.	DESCRIPTION	SKETCH	Q'TY (PCS)
1	FLAT WASHER Ø5/16 x 3/4"		11
2	WASHER Ø5/16 x 1/2"		11
3	BOLT Ø5/16 x 2"		8
4	ALLEN KEY Ø5/16 x 3 1/4"		1
5	THREAD BOLT Ø5/16 x 3 1/4"		3
6	HEX NUT Ø5/16 x 1/2"		3
7	WRENCH 1/2" x 3 1/2"		1

ASSEMBLY INSTRUCTIONS

STEP 1:

Lay the seat frame (A) on its backside to reach the holes to secure the bolts for the arms. Align and assemble the LSF arm (B) and RSF arm (C) to the seat frame (A) by using the Allen Key (4) with hardware 1, 2, and 3. Screw the support legs (F) to the bottom of seat frame (A).

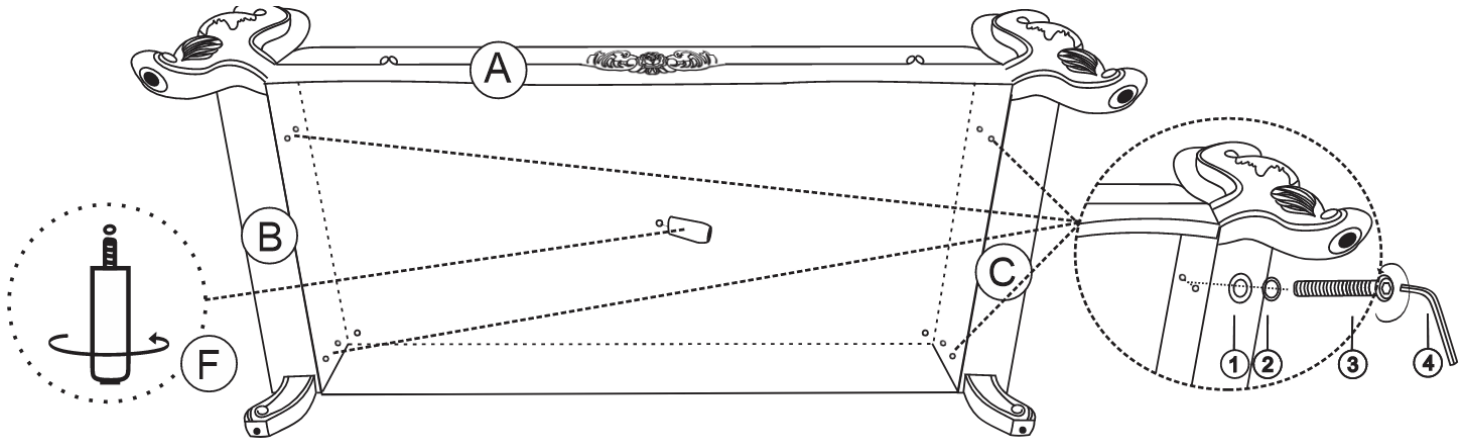

STEP 2:

Place the backrest (D) on its backside. Install the thread bolt (5) into the hole on the bottom of the backrest (D) by using your hands to rotate the bolt about 25 mm into the backrest (D).

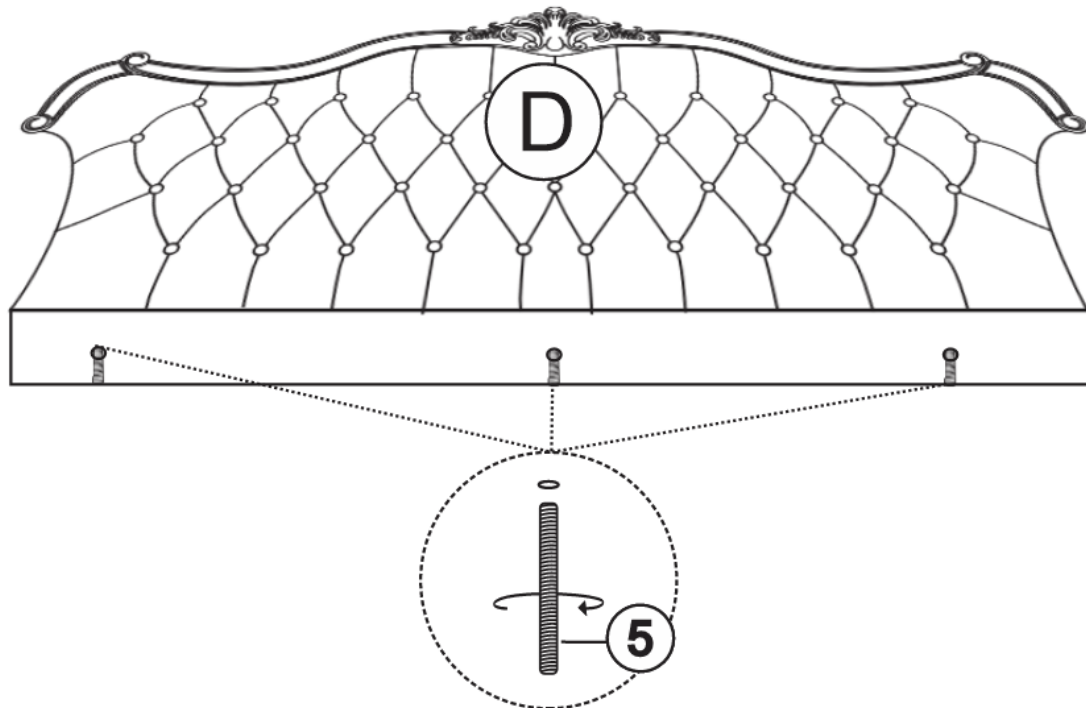

ASSEMBLY INSTRUCTIONS

STEP 3:

Place the frame up right and install the backrest (D) to the LSF arm (B) and RSF arm (C) by sliding the brackets all the way until it is secured.

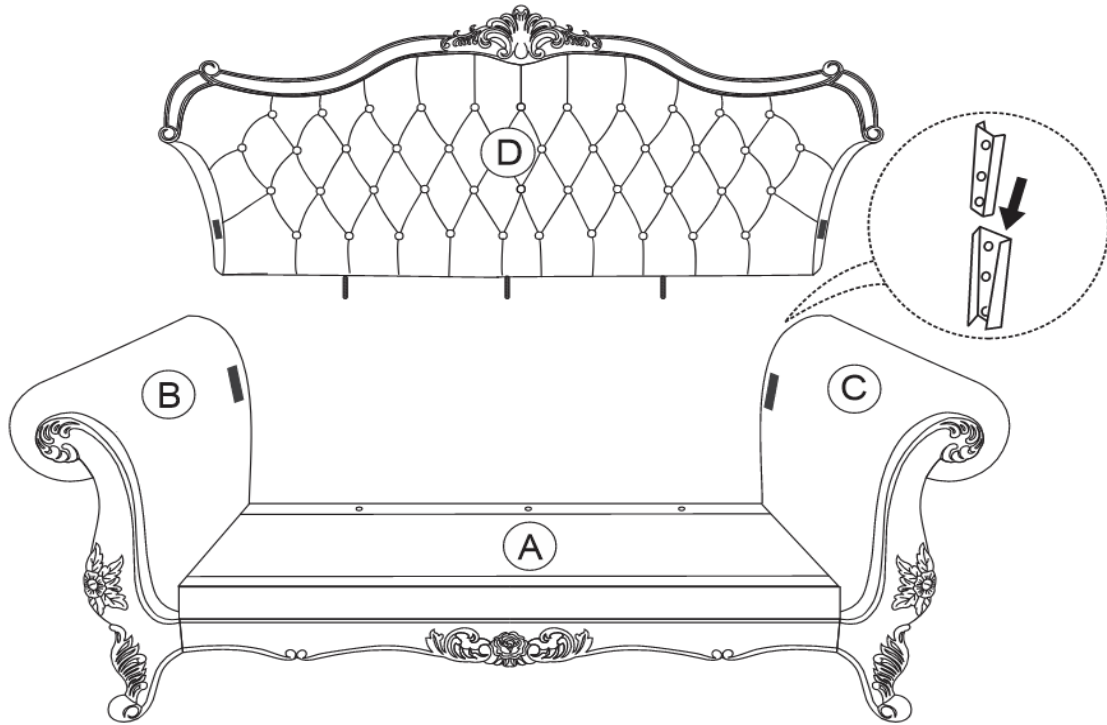

STEP 4:

Place the chair on its back on a clean and soft surface to reach the thread bolt (5). Secure the backrest (D) to the seat frame (A) by using the Wrench (7) with hardware 1,2, and 6.

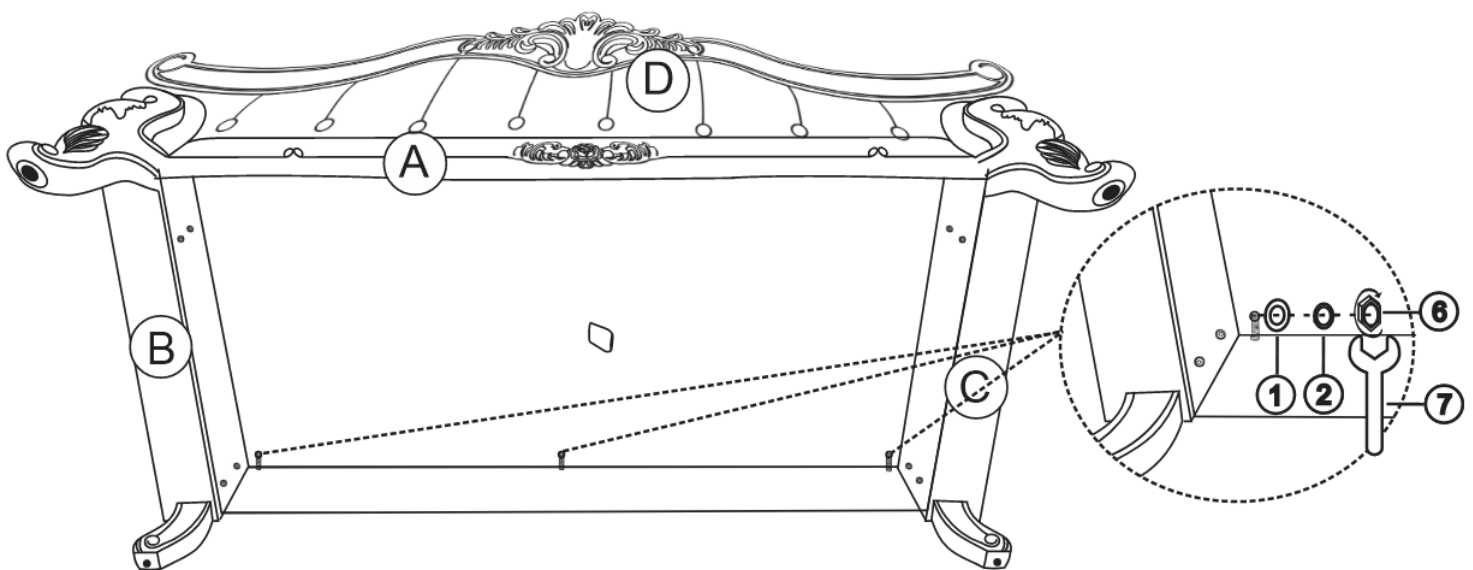

ASSEMBLY INSTRUCTIONS

STEP 5:

Place the chair up right and install the seat cushion (E) to the seat frame (A).

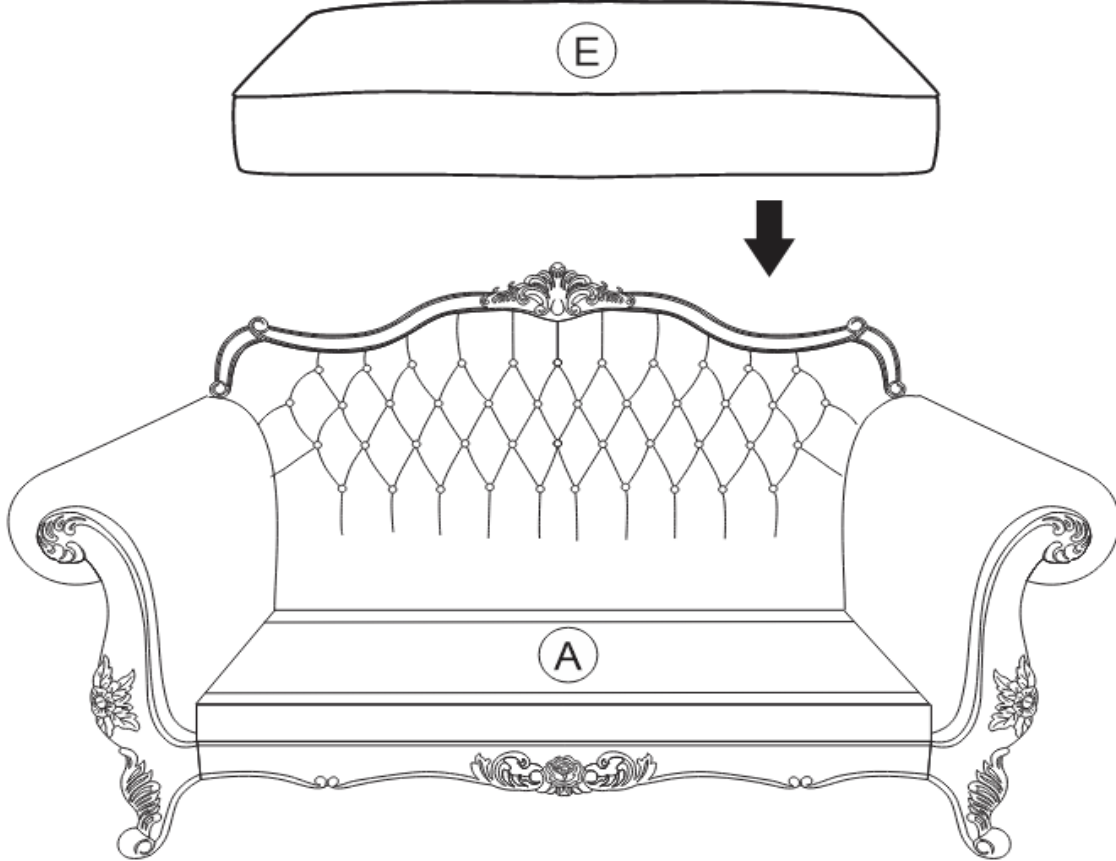

FINISH

