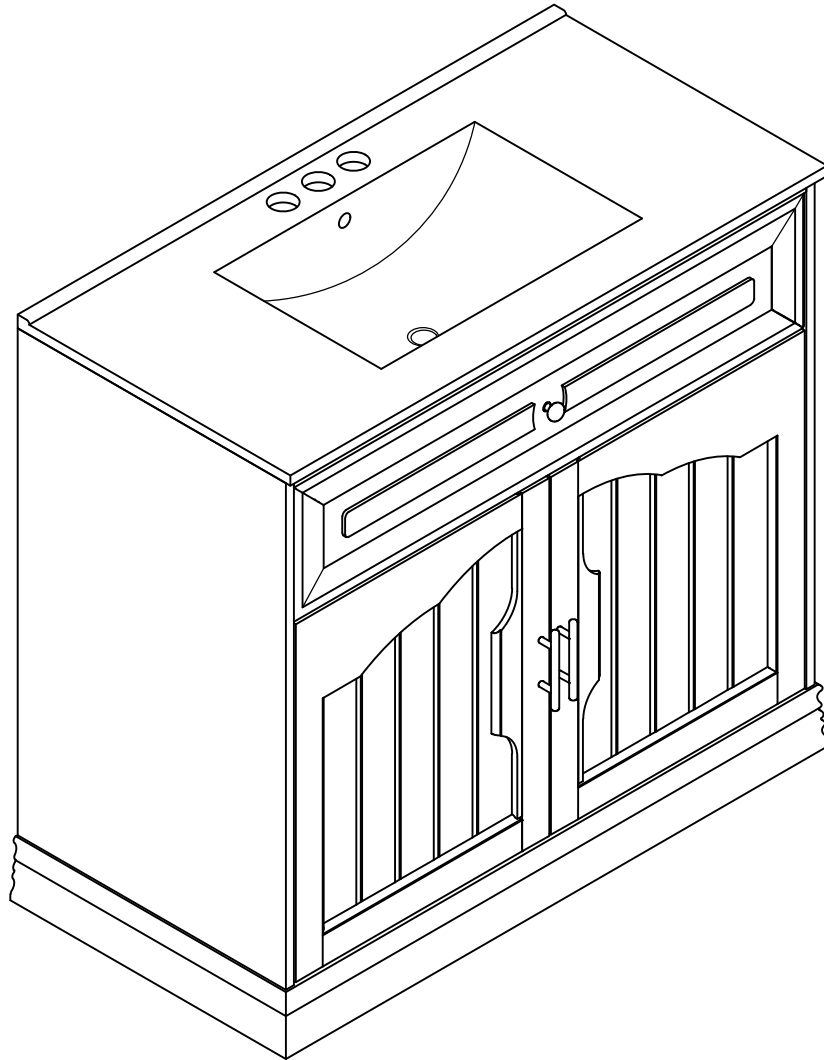


# ASSEMBLY INSTRUCTIONS

## 36 INCH BATH VANITY (COMBO)

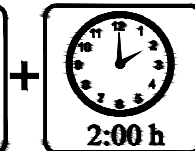
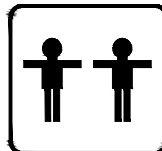
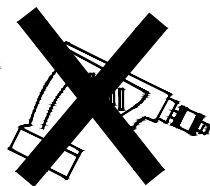


Thank you for purchasing this quality product. Be sure to check all packing material carefully for small parts which may have come loose inside the carton during shipment. Separate, identify and count all parts and hardware.

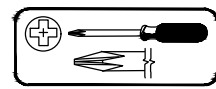
Compare with the parts list to be sure all parts are present.

**"DO NOT TIGHTEN SCREWS UNTIL COMPLETELY ASSEMBLED"**

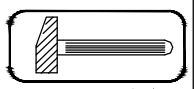
**\* Use of power tool to assemble this product will invalidate any claim and damage this product making unsafe !!!**  
**\* Please assemble on a clean soft surface to avoid damage.**



### Tools Required



(Not included)



(Not included)

**IMPORTANT:**

**PLEASE READ INSTRUCTION BEFORE STARTING THE ASSEMBLY**

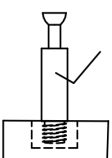
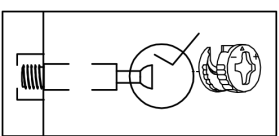
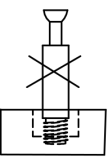
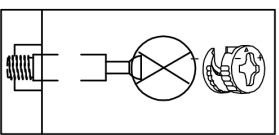
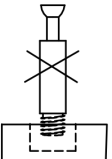
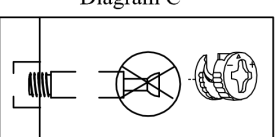
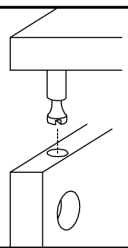
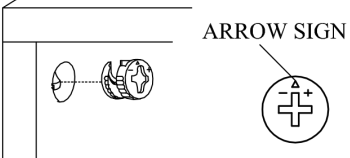
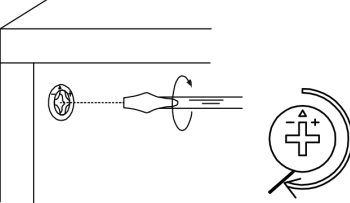
# Before Installation

Important – Please read these instructions fully before starting assembly

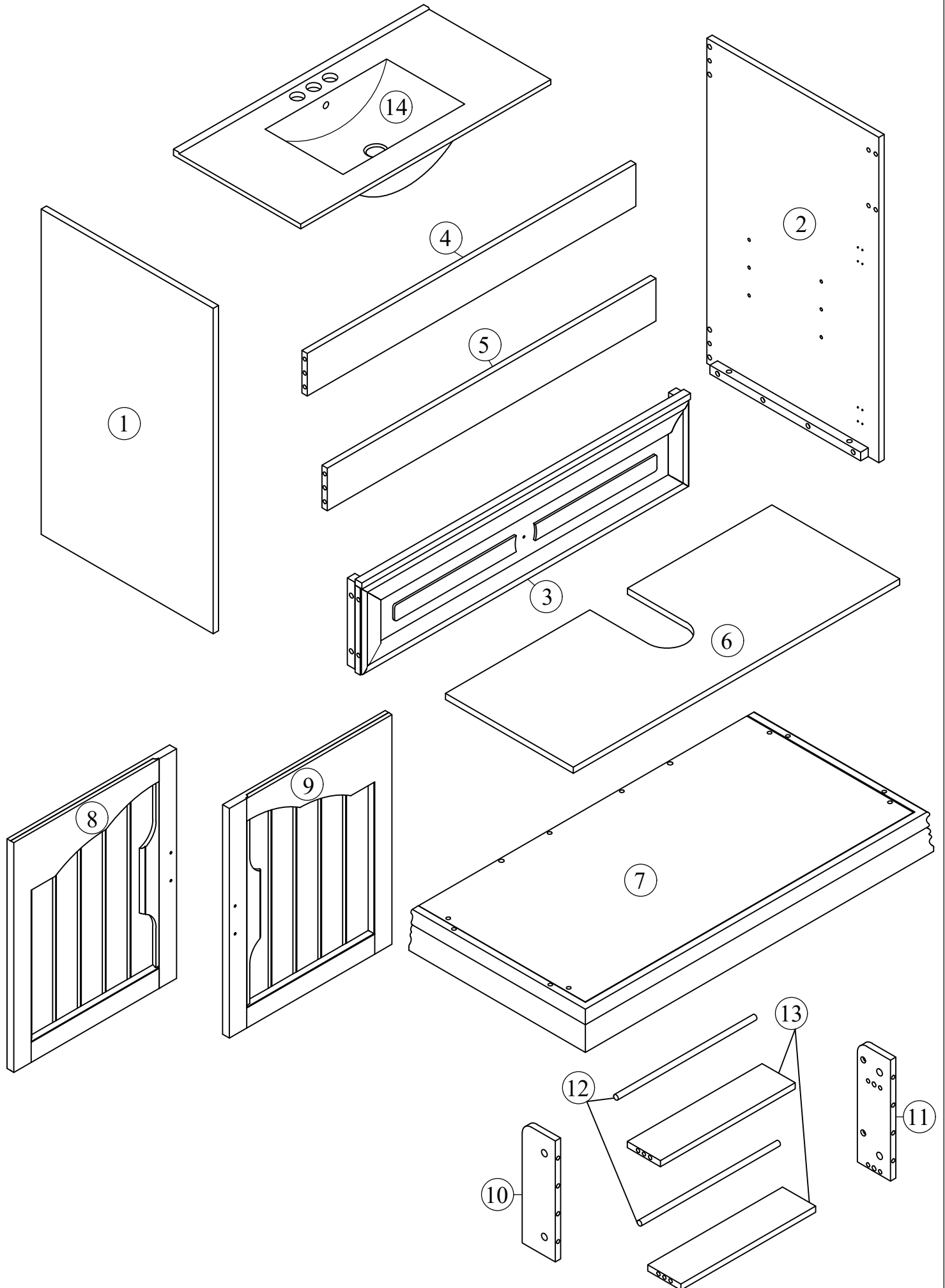
Thank you for purchasing this quality product. Be sure to check all packing materials carefully for small parts, which may have come loose inside the carton during shipment. Identify and count all items according to the PARTS LIST and/or HARDWARE LIST shown below. Check you have all the components and tools listed on the following pages.

- We recommend that you assemble this product with the assistance of another person; this will make the assembly easier, and will help eliminate damage to the product or injury to persons during assembly.
- Please do not over tighten screws or bolts until the assembly is completed.
- Keep children and animal away from the work area, small parts could choke if swallowed.
- Please put all parts on a non-abrasive floor before assembly, and follow the assembly steps to assemble your newly purchased product correctly and efficiently.

## Cam Lock Assembly Instructions

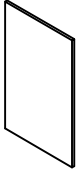
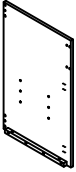
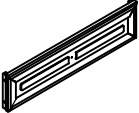
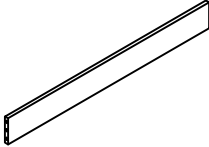
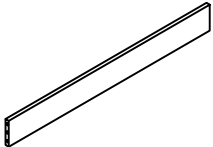
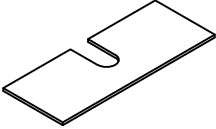
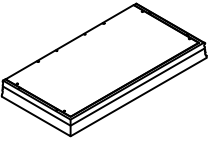
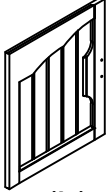
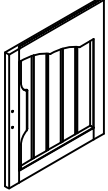

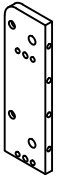
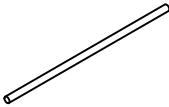
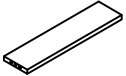
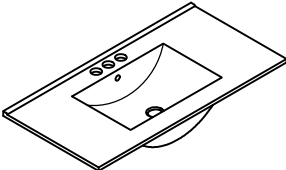
		Diagram A	Insert Cam Bolt into hole as shown in diagram A.
		Diagram B	Make sure not to insert the Cam Bolt: Too deep as shown in figure B as this will cause the Cam Lock to be misaligned and unable to interlock properly.
		Diagram C	Also avoid inserting the Cam Bolt too close to the surface of the hole as shown in figure C, as this will cause the Cam Lock to be too loose, and not interlock properly.
			Connect the panels together.
	ARROW SIGN		Insert the Cam Lock so the side opening fits over the head of the Cam Bolt.
			To tighten the Cam Lock, turn it clockwise on half a turn with a flat screwdriver. <i>*Do not use an automatic screwdriver as it may bend or break if too much power is imposed.</i>

# Detail View - CABINET



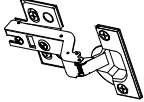
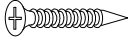

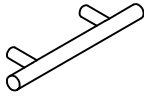

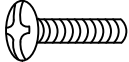
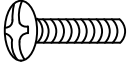



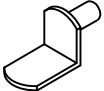
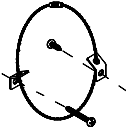


**Identifying the Hardware**-Identify the hardware using the illustrations below.

# Part List

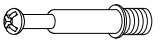
<p>1</p>  <p>Side Panel (L) - 1pc</p>	<p>2</p>  <p>Side Panel (R) - 1pc</p>
<p>3</p>  <p>Drawer Fake - 1pc</p>	<p>4</p>  <p>Top Rear Bar - 1pc</p>
<p>5</p>  <p>Bottom Rear Bar - 1pc</p>	<p>6</p>  <p>Adjustable Shelf - 1pc</p>
<p>7</p>  <p>Bottom Frame - 1pc</p>	<p>8</p>  <p>Door (L) - 1pc</p>
<p>9</p>  <p>Door (R) - 1pc</p>	<p>10</p>  <p>Panel Left Side Door (R) - 2pcs</p>
<p>11</p>  <p>Panel Right Side Door (R) - 2pcs</p>	<p>12</p>  <p>Round Bar Door - 4pcs</p>
<p>13</p>  <p>Panel Mid Door - 4pcs</p>	<p>14</p>  <p>Sink - 1pc</p>

# Hardware List

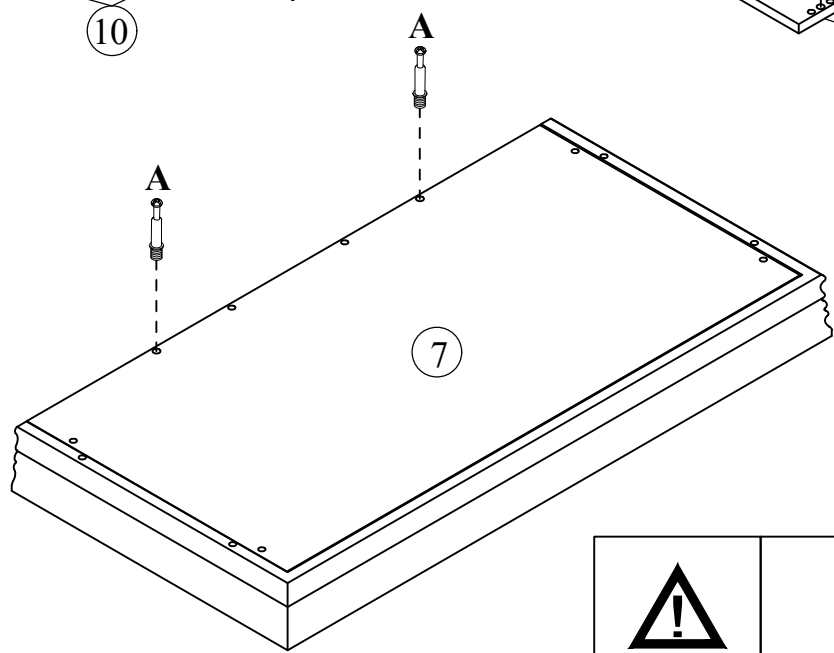
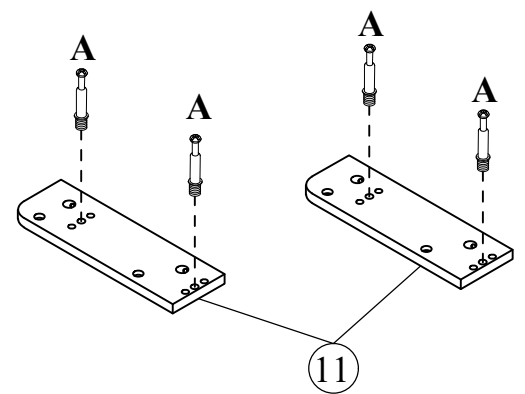
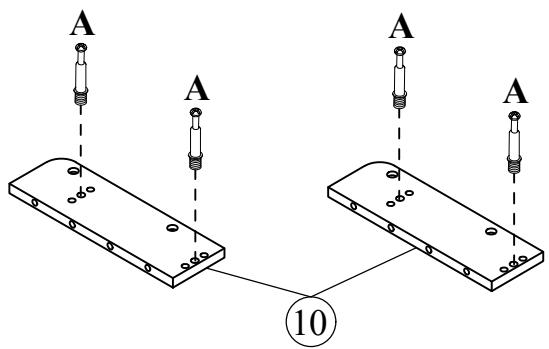
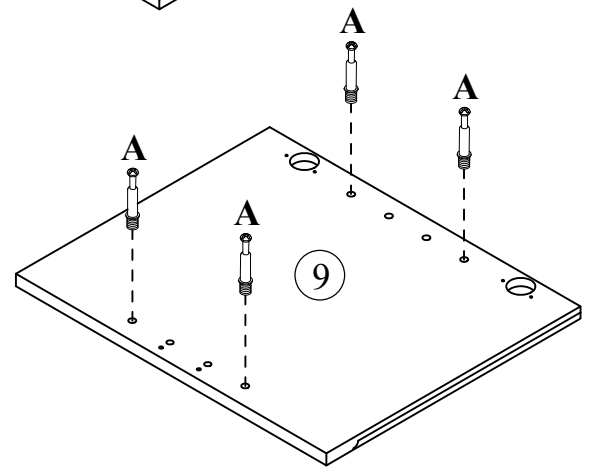
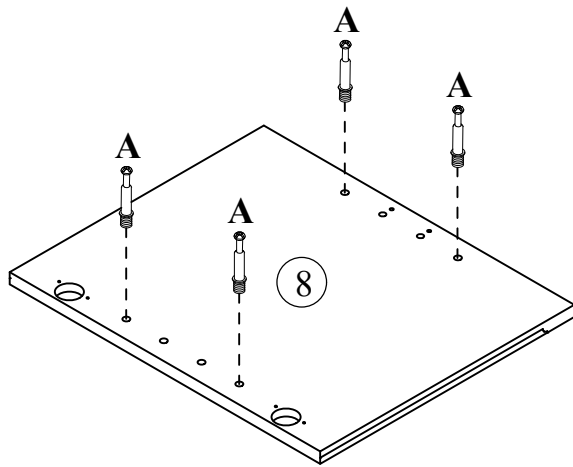
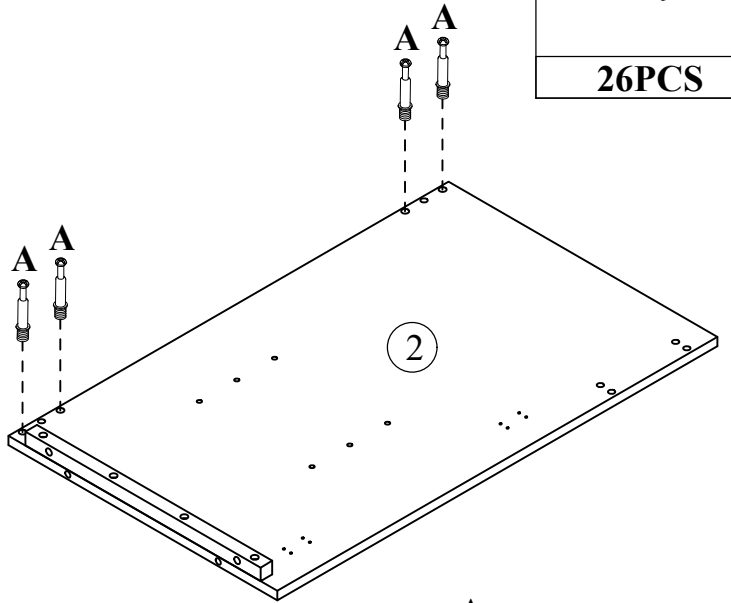
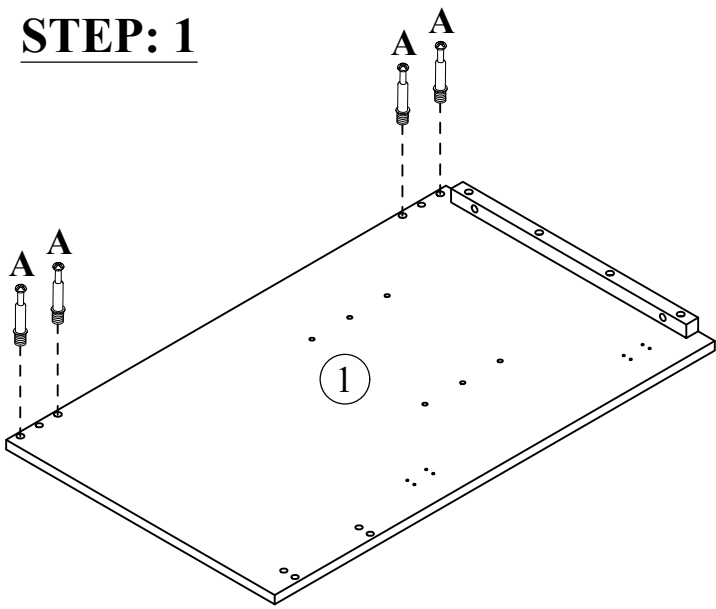
<p><b>A</b></p>  <p>ø6x35mm</p>	<p><b>B</b></p>  <p>ø14.5x12mm</p>	<p><b>C</b></p>  <p>ø35mm</p>
<p>Three in one bolts (26pcs)      Three in one lock (26pcs)      Damping hinge (4pcs)</p>		
<p><b>D</b></p>  <p>ø7xø3.5x12mm</p>	<p><b>E</b></p>  <p>ø8x30mm</p>	<p><b>F</b></p> 
<p>Flat head screw (24pcs)      Wood dowel (38pcs)      Handle (2pcs)</p>		
<p><b>G</b></p>  <p>ø25x25mm</p>	<p><b>H</b></p>  <p>ø5/32"x19mm</p>	<p><b>I</b></p>  <p>ø5/32"x25mm</p>
<p>Handle (1pcs)      Handle screw (1pc)      Handle screw (4pcs)</p>		
<p><b>J</b></p>  <p>ø1/4"x32mm</p>	<p><b>K</b></p>  <p>ø1/4"x16x1mm</p>	<p><b>L</b></p>  <p>4mm</p>
<p>Hex-Head bolts(8pcs)      Washer(8pcs)      Allen key(1pc)</p>		
<p><b>M</b></p>  <p>ø6.2x31x19x16mm</p>	<p><b>N</b></p> 	
<p>Laminate pad (4pcs)      Anti fall hardware(2sets)</p>		


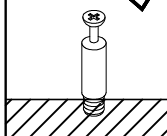
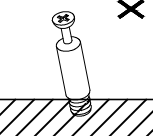
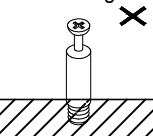
# STEP: 1

**A**

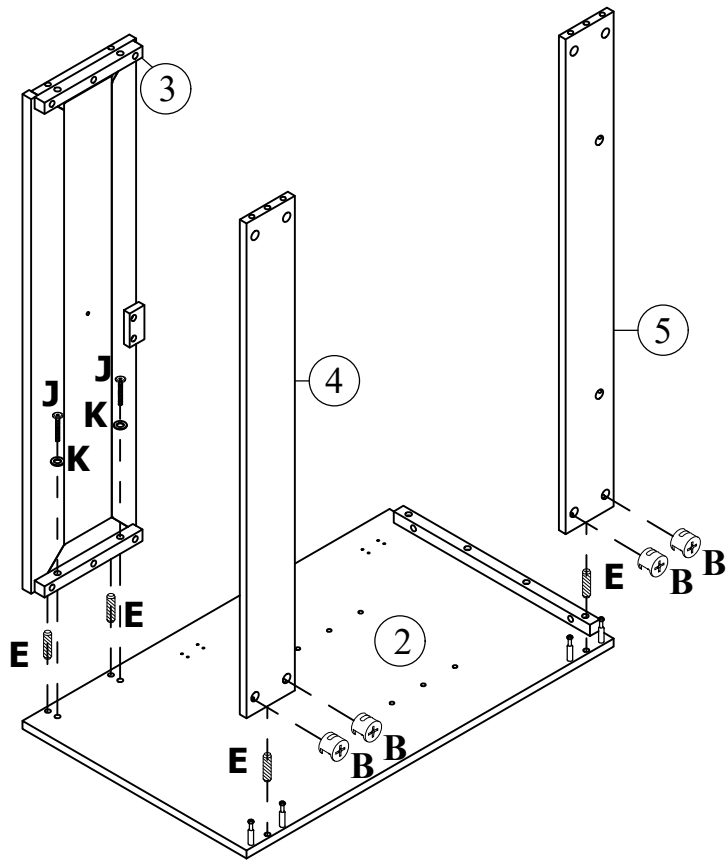


**26PCS**

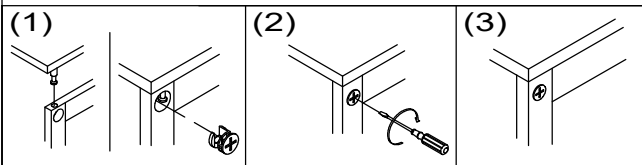


	 ✓	 Don't lean ✗	 Don't over tighten ✗
--	---	--	--

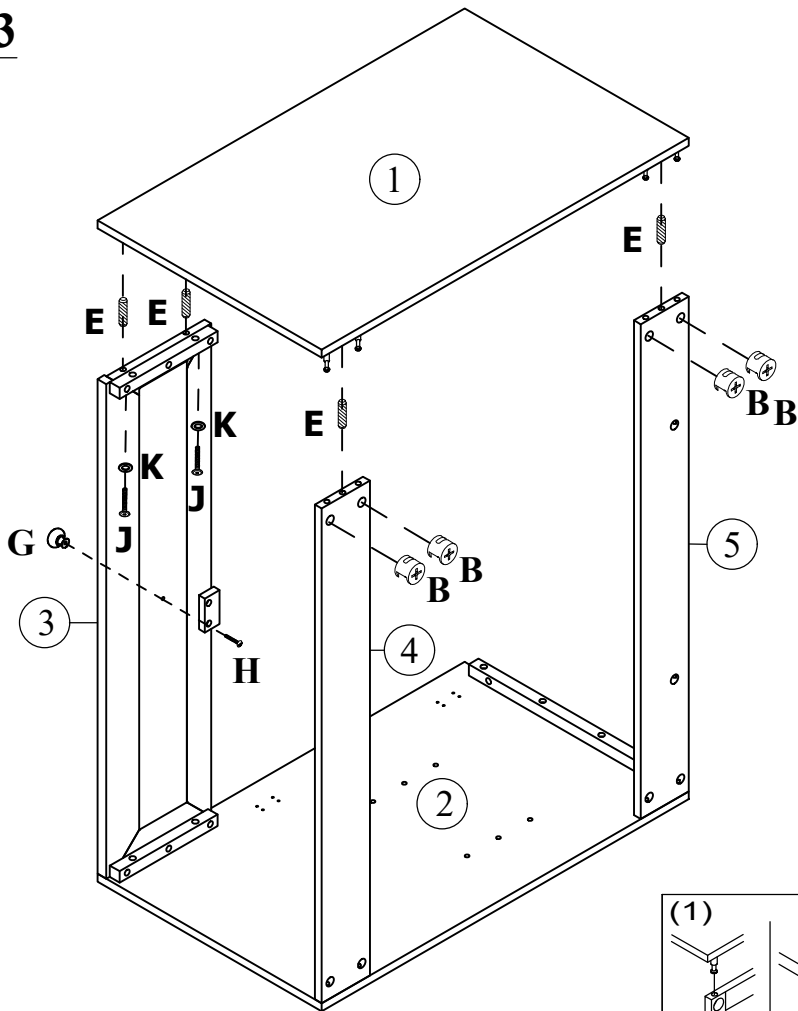
# STEP: 2



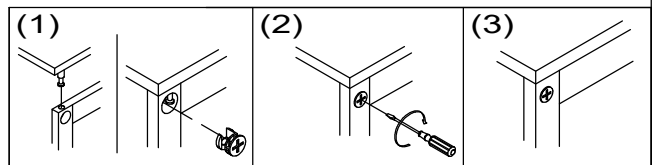
<b>B</b>		<b>E</b>	
	4PCS		4PCS
<b>J</b>		<b>K</b>	
	2PCS		2PCS







# STEP: 3

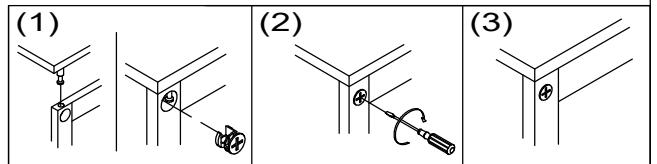
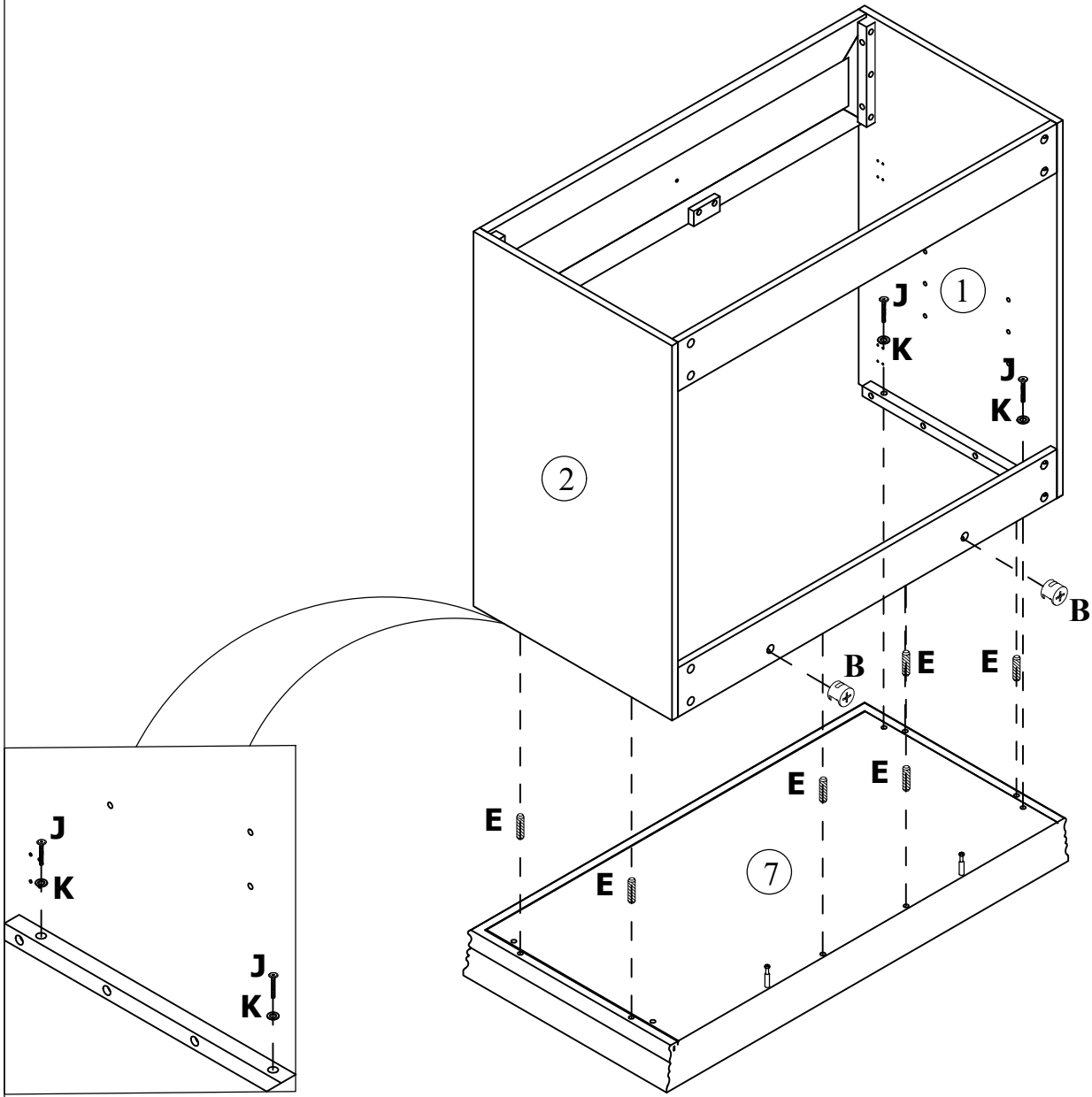


<b>B</b>		<b>E</b>	
	4PCS		4PCS
<b>G</b>		<b>H</b>	
	1PC		1PC
<b>J</b>		<b>K</b>	
	2PCS		2PCS


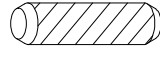


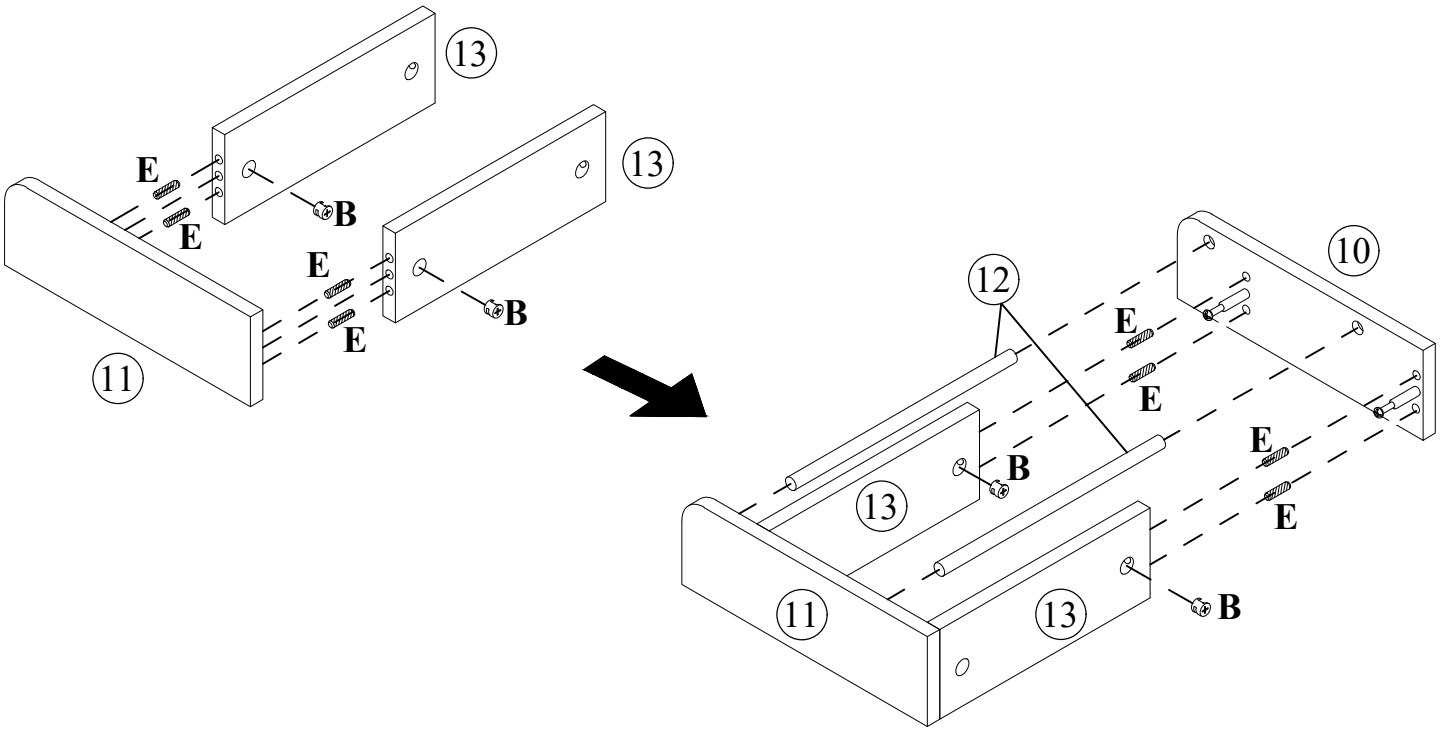
# STEP: 4

<b>B</b> 	<b>E</b> 	<b>J</b> 	<b>K</b> 
<b>2PCS</b>	<b>6PCS</b>	<b>4PCS</b>	<b>4PCS</b>






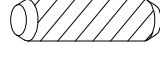
# STEP: 5

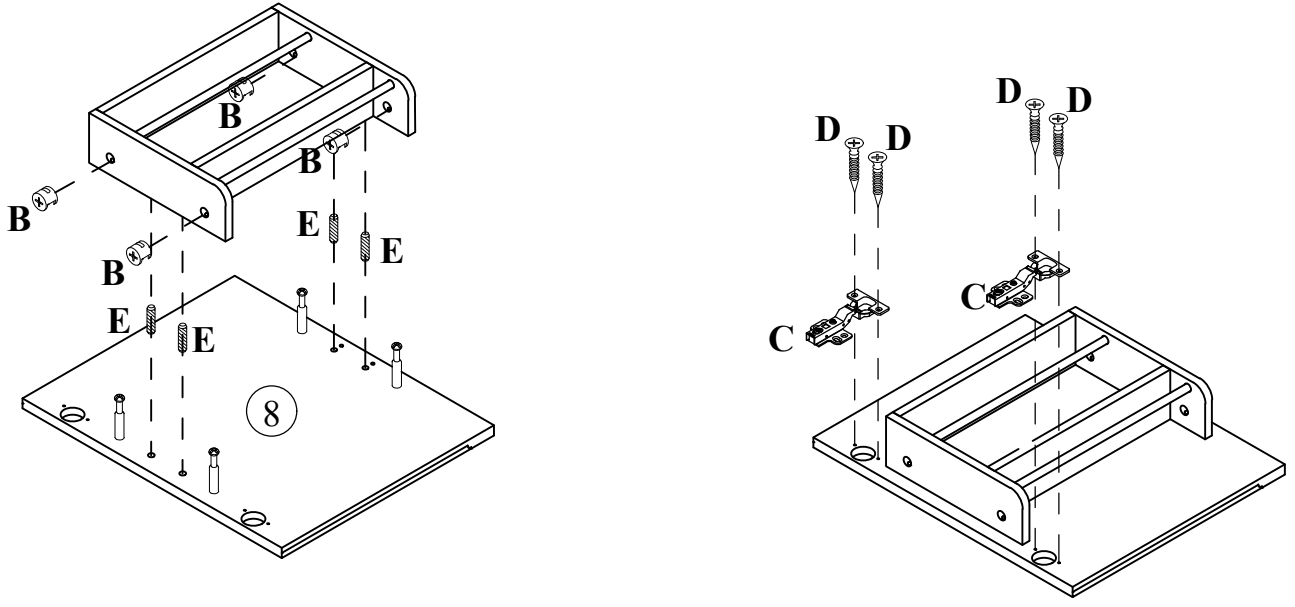
<b>B</b>		<b>E</b>	
<b>8PCS</b>		<b>16PCS</b>	







**x2**

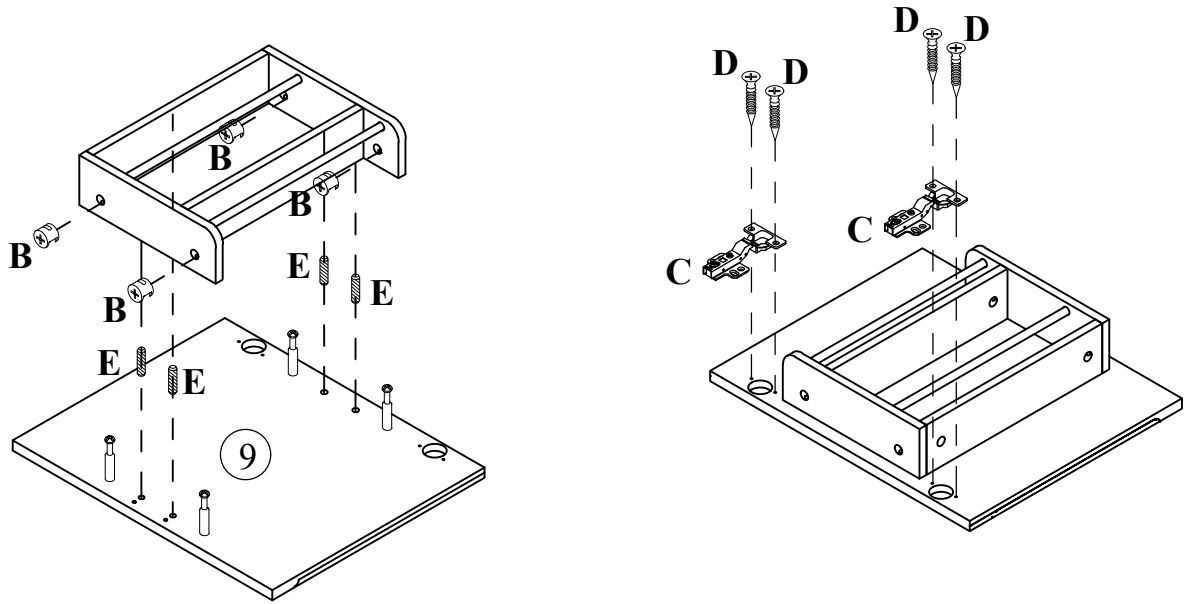
# STEP: 6

<b>B</b>		<b>C</b>		<b>D</b>		<b>E</b>	
<b>4PCS</b>		<b>2PCS</b>		<b>4PCS</b>		<b>4PCS</b>	

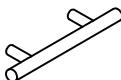
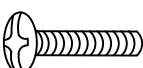



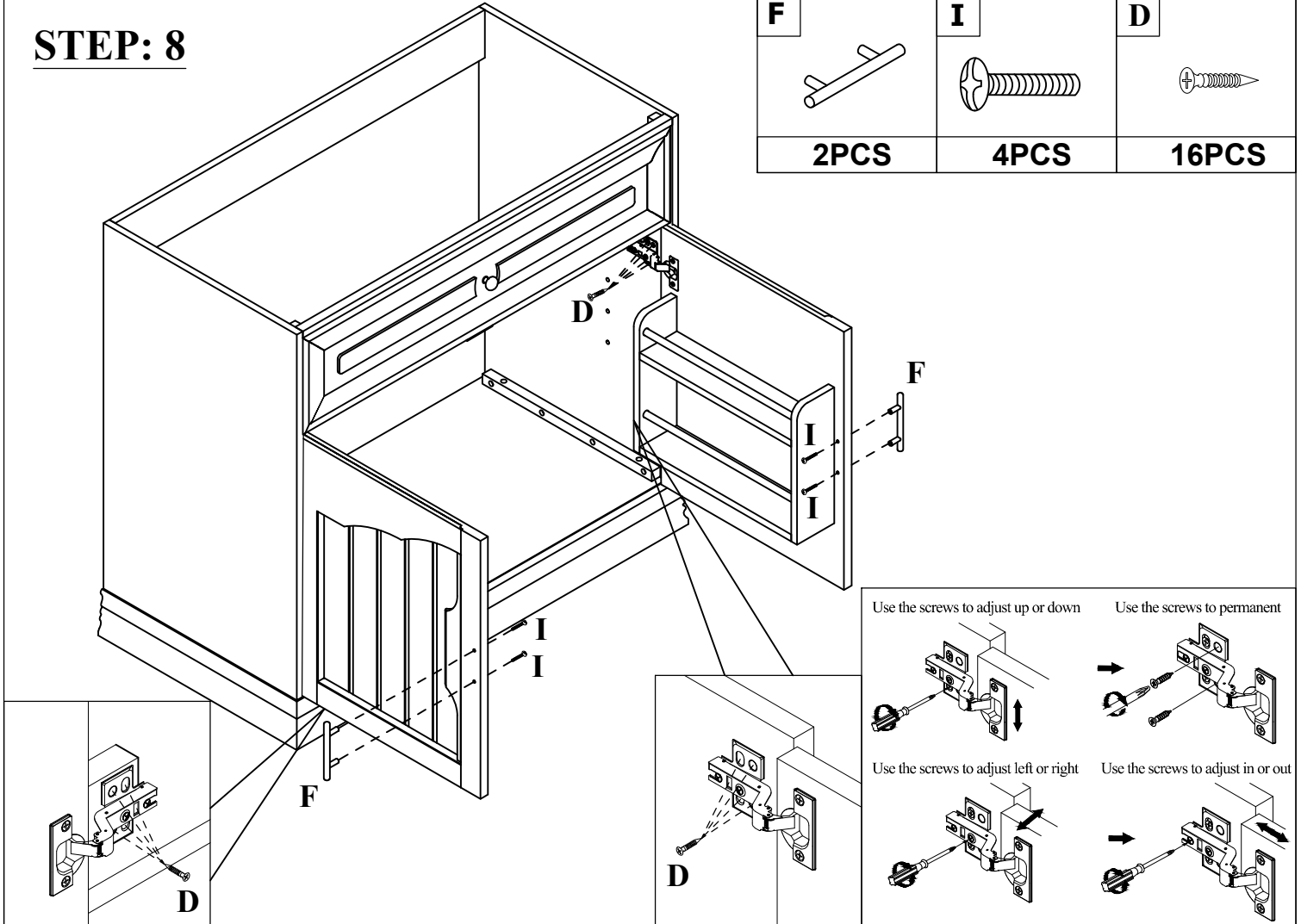
# STEP: 7

<b>B</b>	<b>C</b>	<b>D</b>	<b>E</b>
			
<b>4PCS</b>	<b>2PCS</b>	<b>4PCS</b>	<b>4PCS</b>



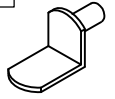
# STEP: 8

<b>F</b>	<b>I</b>	<b>D</b>
		
<b>2PCS</b>	<b>4PCS</b>	<b>16PCS</b>

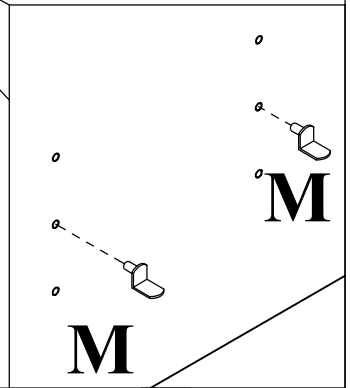
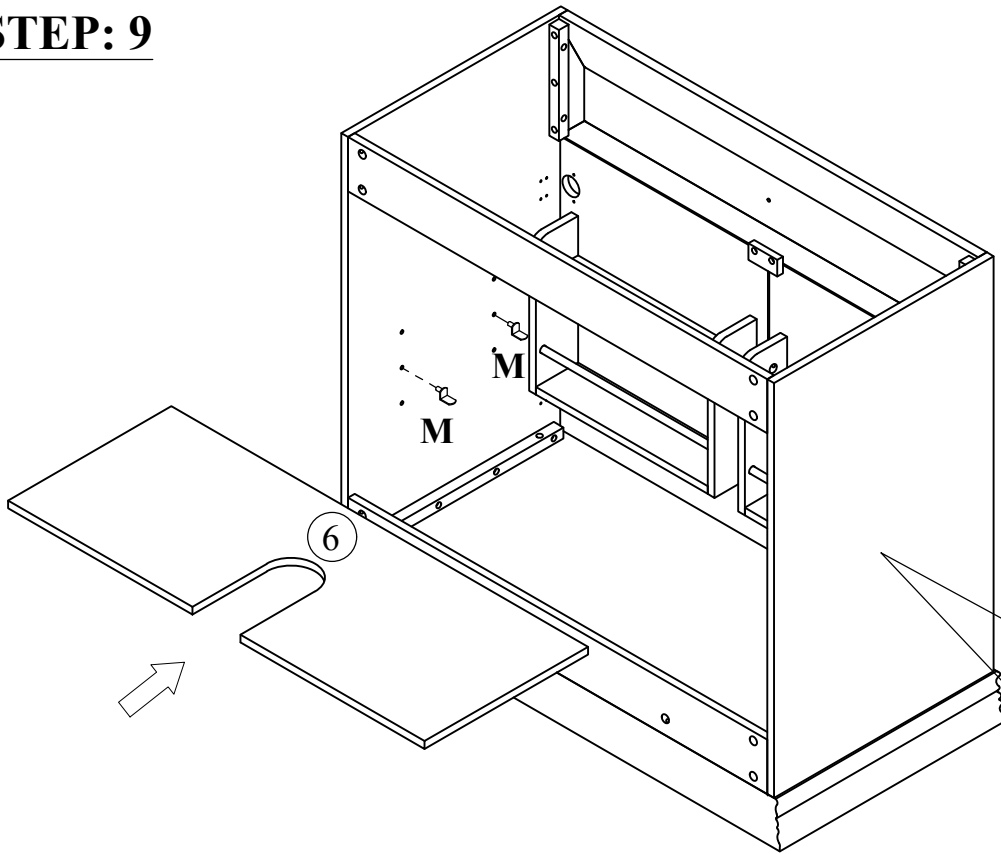


**STEP: 9**

**M**

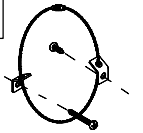


**4PCS**

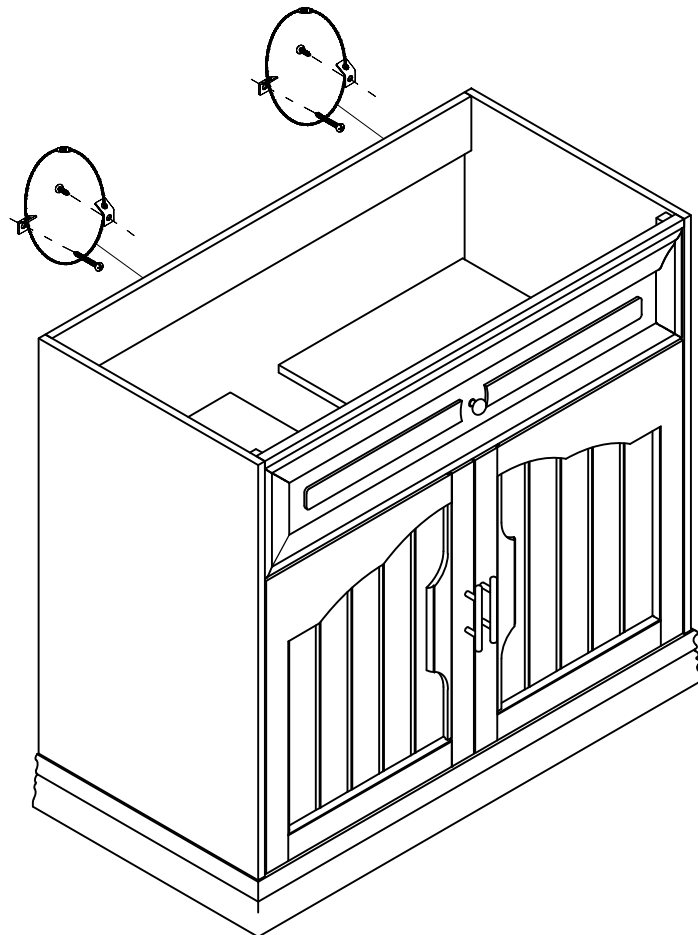


**STEP: 10**

**N**

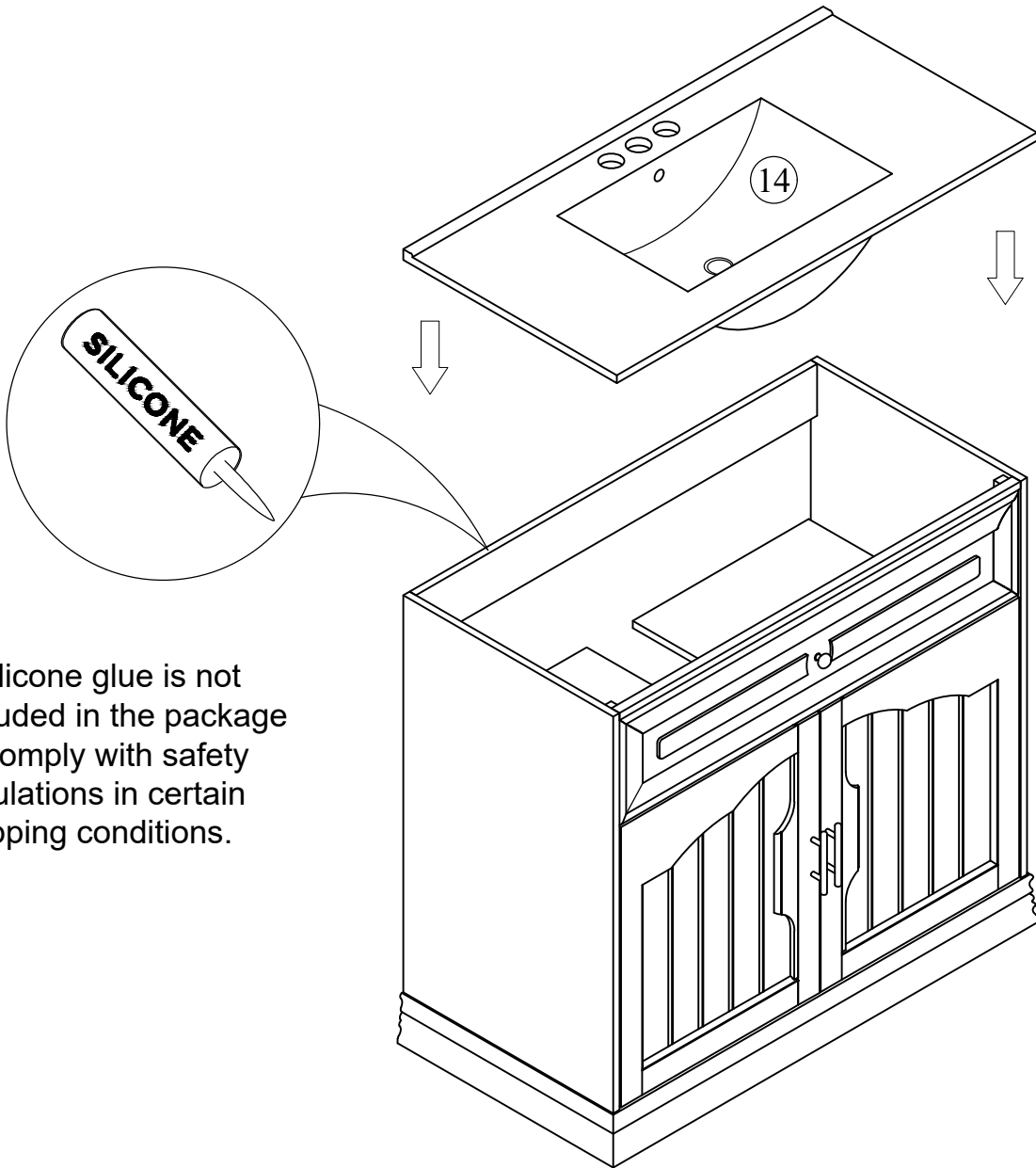


**2SETS**



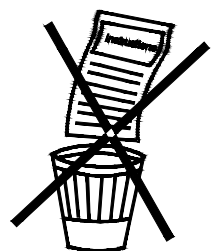
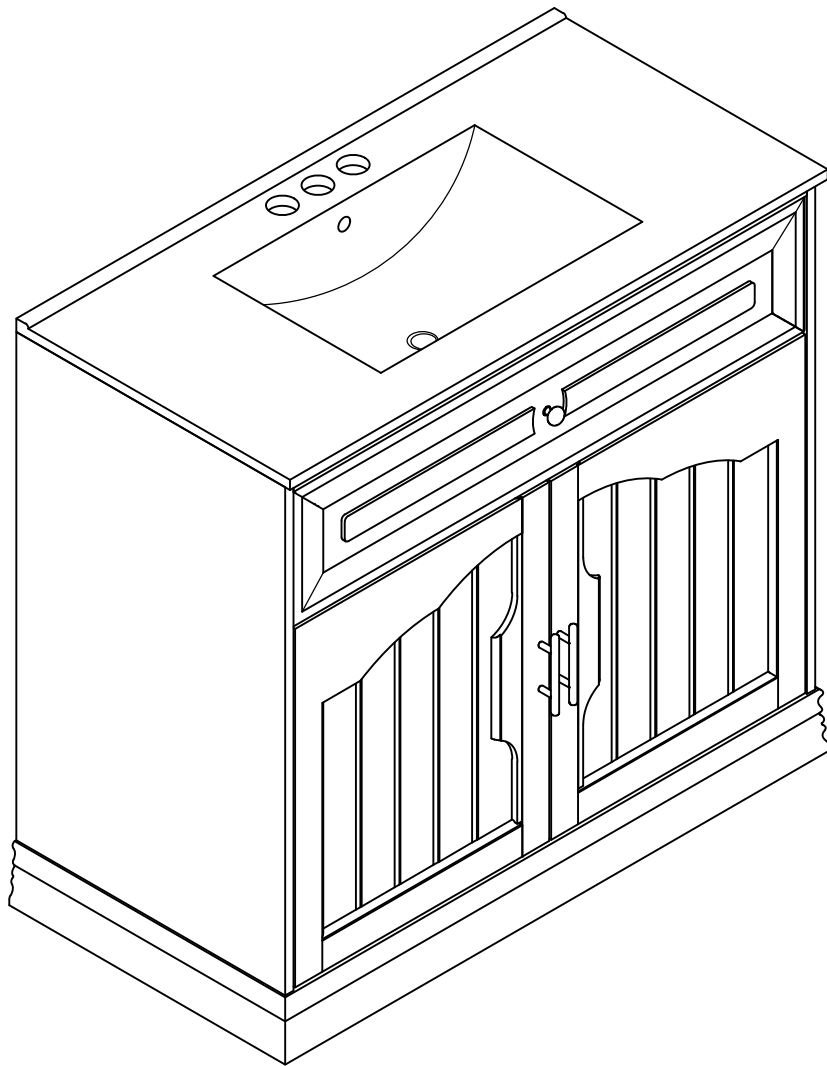
## **STEP: 11**

Install the sink on the cabinet with glue.  
Let stand for 24 hours

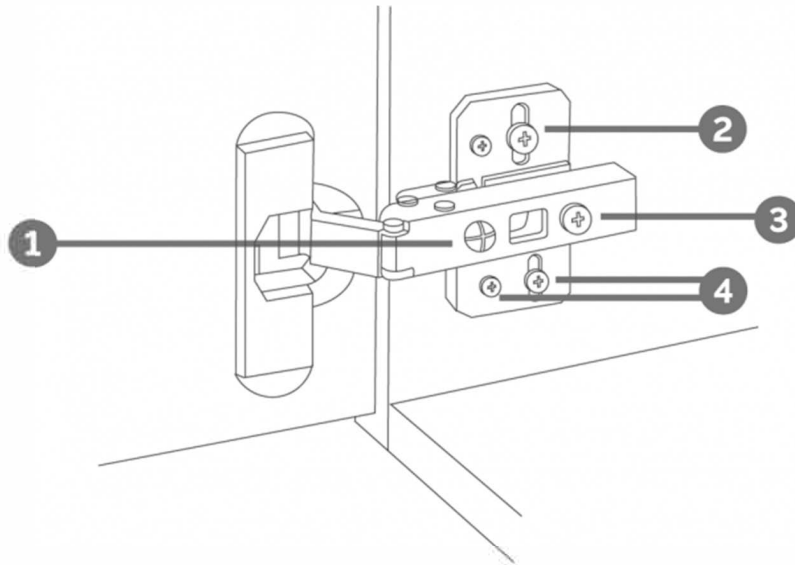


\*Silicone glue is not included in the package to comply with safety regulations in certain shipping conditions.

**STEP: 12**

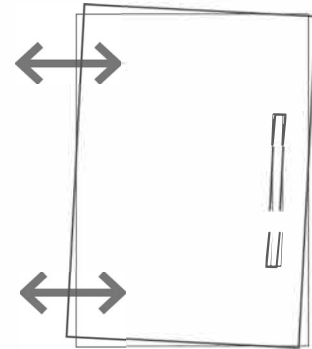


# HINGE ADJUSTMENTS



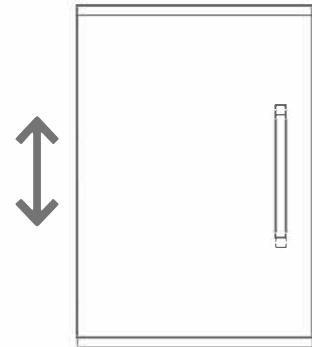
## 1 Sideways / Tilt adjustment

Turn the screw  
**clockwise** to move the door further away from  
the side of the cabinet  
**anticlockwise** to move the door closer to the  
side of the cabinet



## 2 4 Height adjustment

While supporting the weight of the door, turn the  
screws  
**clockwise** to move the door up  
**anticlockwise** to move the door down



## 3 Forward and back adjustment

If the gap between the back of the door and the  
cabinet is too small, and the door may not close  
fully. Turn the screw  
**clockwise** to decrease the gap between the  
door and the cabinet  
**anticlockwise** to increase the gap between the  
door and the cabinet

