

# U-Shaped Sofa

## Instruction Manual

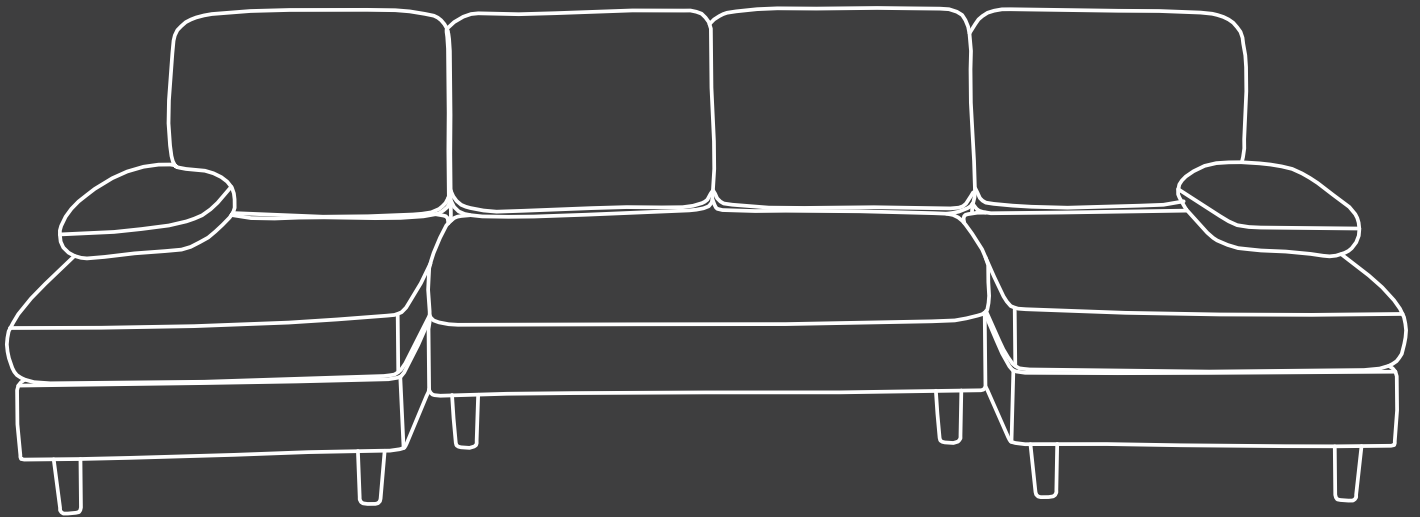

# 1 Component List

---

**A1** x1

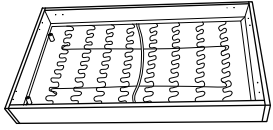

**A2** x1

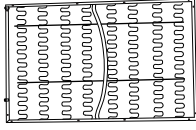

**B** x1

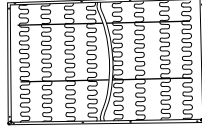

**C** x2

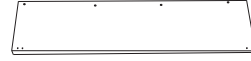

**D** x2



**E** x2



**F** x2



**G** x2

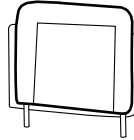

**H** x1

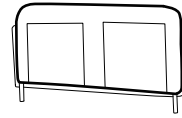

**I1** x1

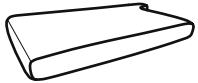

**I2** x1



**J** x1



**K** x2



**L1** x1



**L2** x1



**M** x2



**N** x12



**O** x1



M6

**P** x24



8\*45mm

**Q** x54



8\*20mm

**R** x12



**S** x4



**T** x12



Felt Pads

**U** x6



Split Lock Washer

# Exploded View

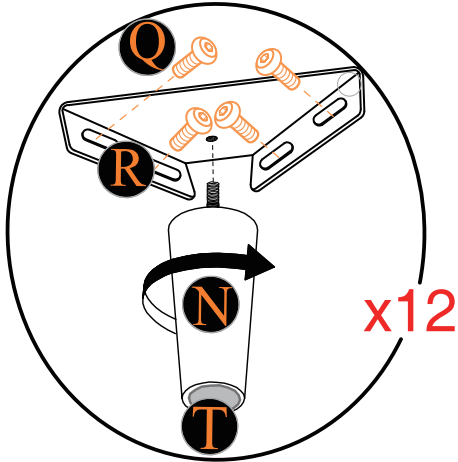
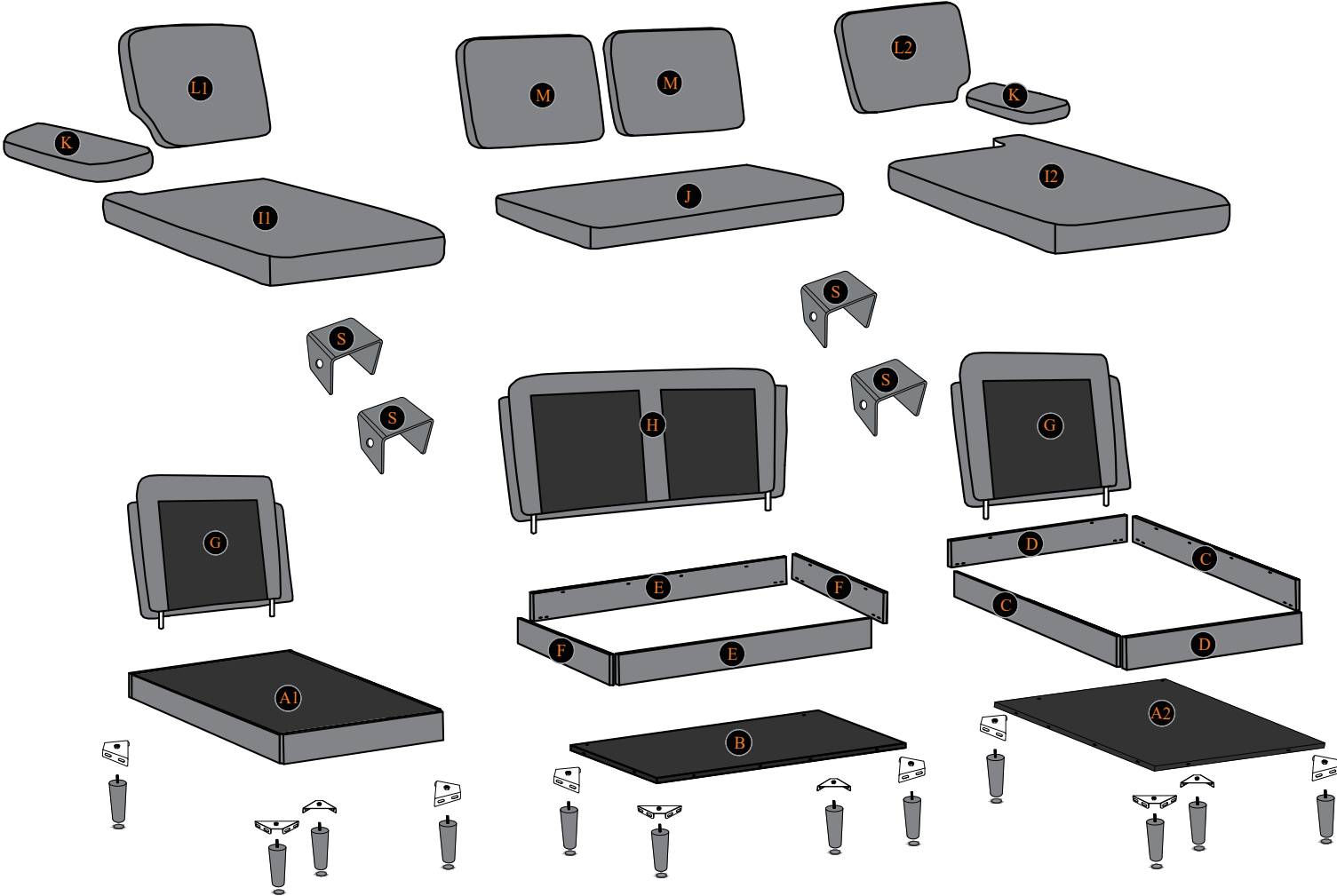



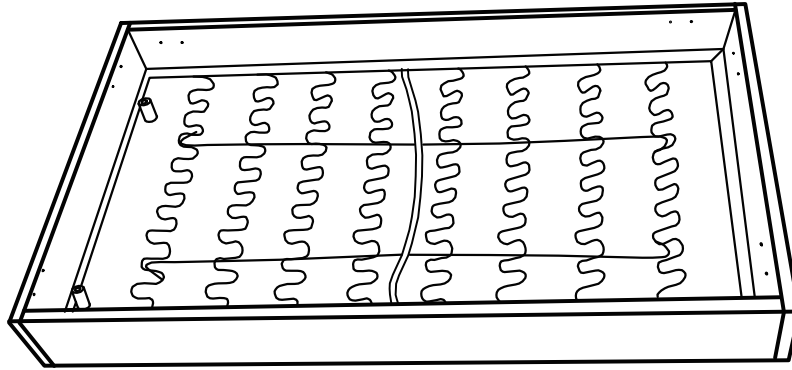

# Step 1

A1

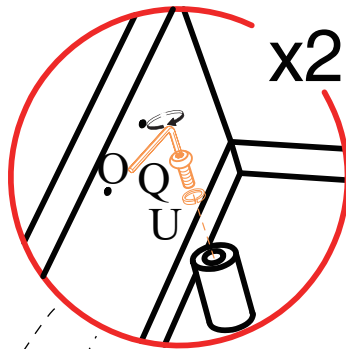
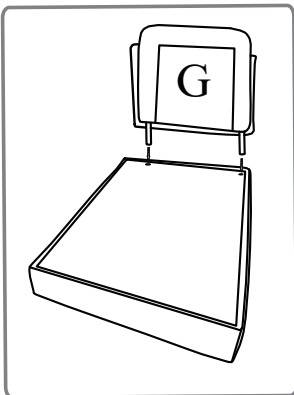

# Step 2



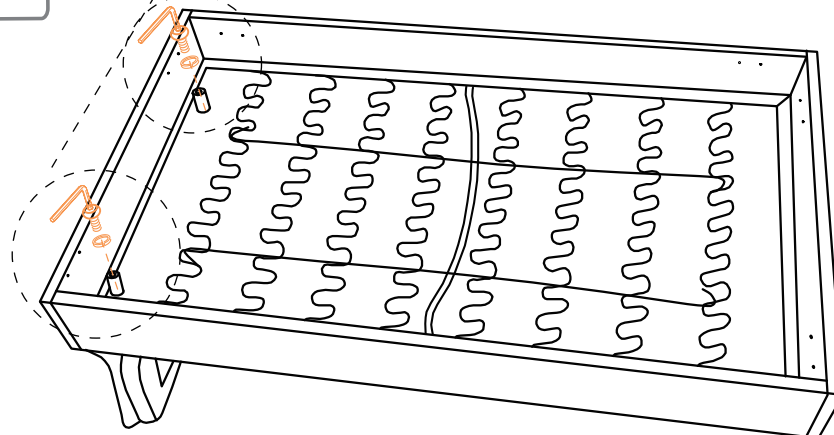

 M6 O*1	 8*20mm Q*2	 U*2
--	--	--

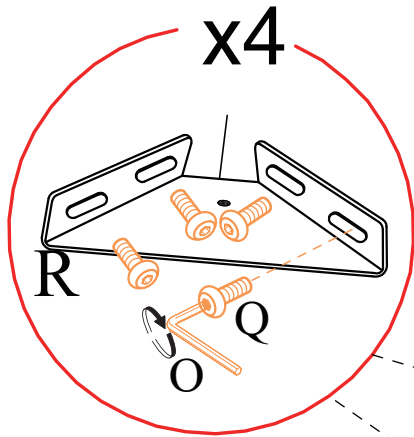

# Step 3

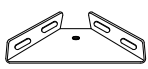

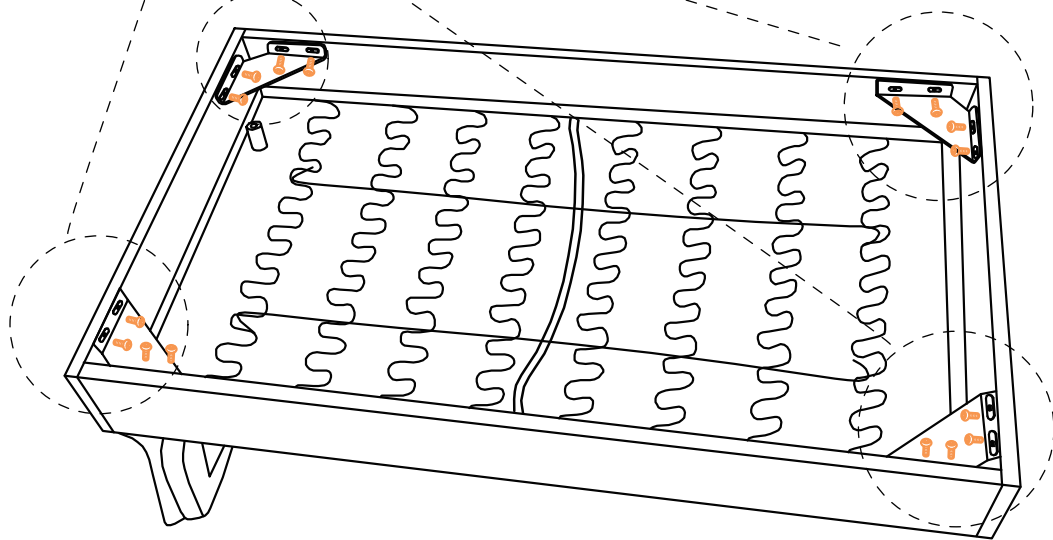

		
R*4	M6 O*1	8*20mm Q*16



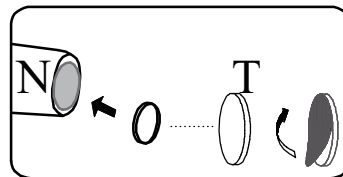
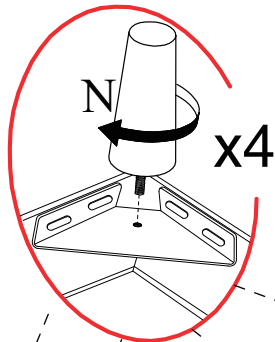

# Step 4

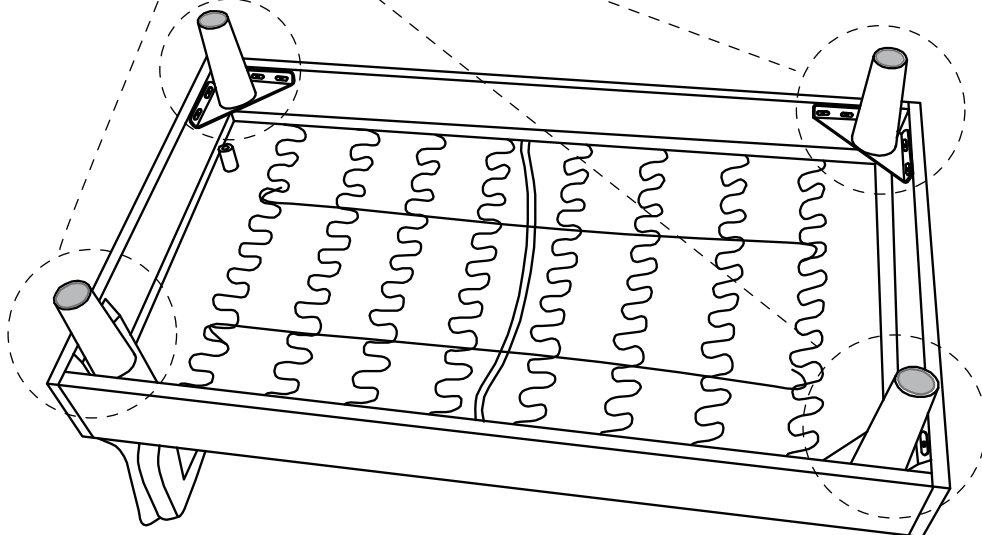

	
N*4	T*4





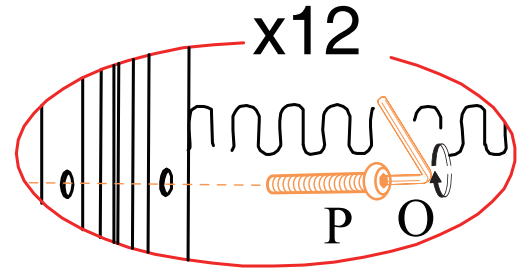
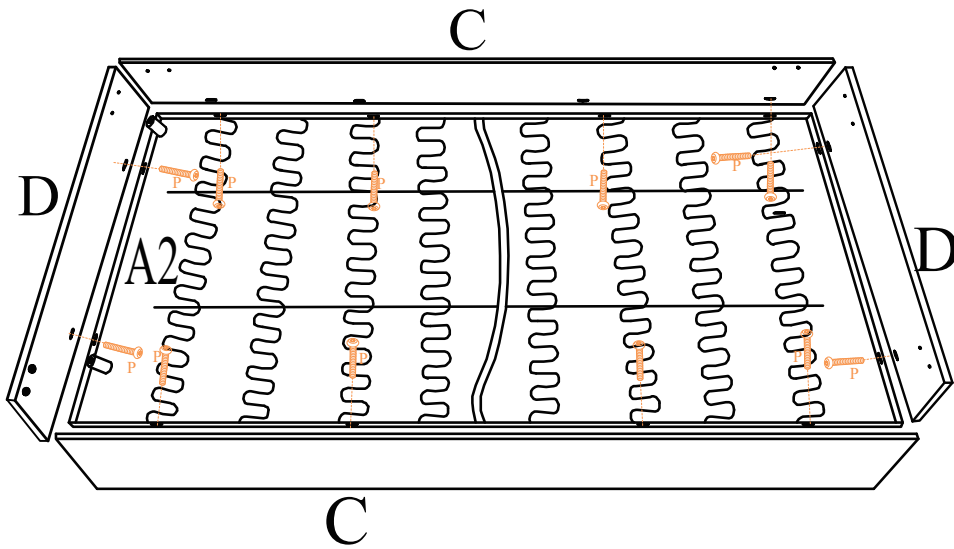

# Step 5

	
M6	8*45mm
O*1	P*12

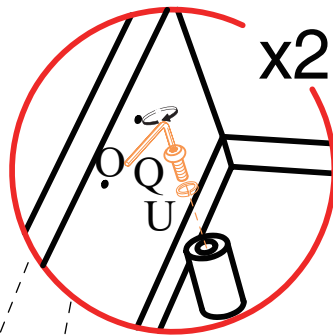
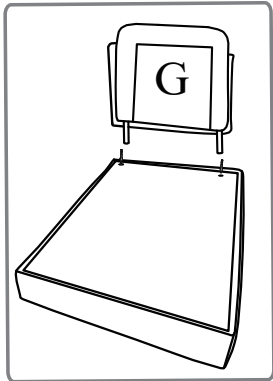

# Step 6



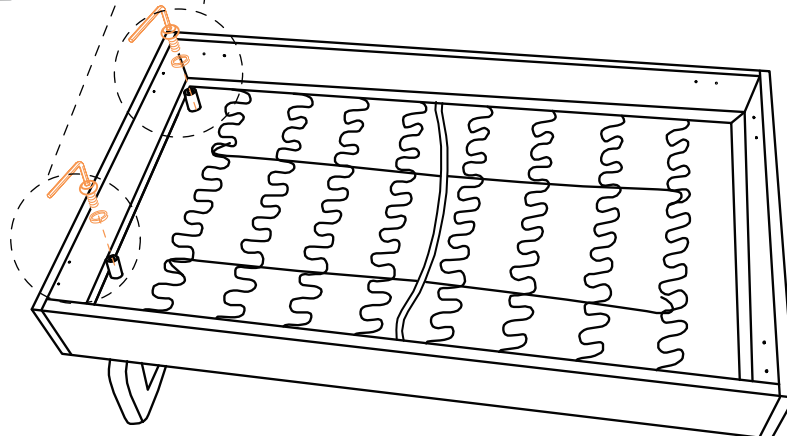

		
M6	8*20mm	
O*1	Q*2	U*2

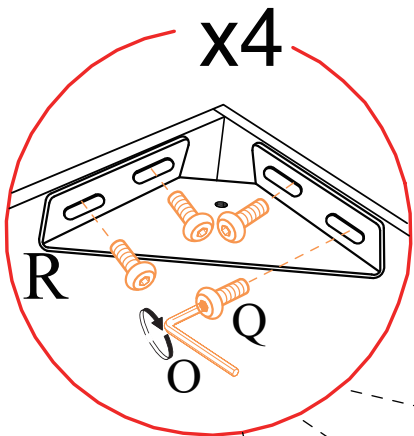

# Step 7

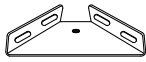

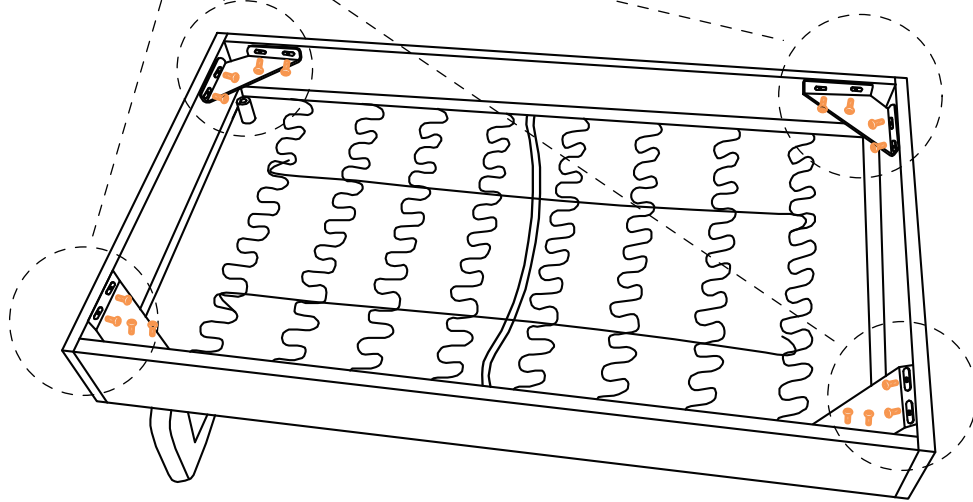

		
R*4	M6 O*1	8*20mm Q*16

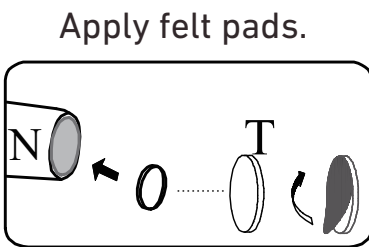
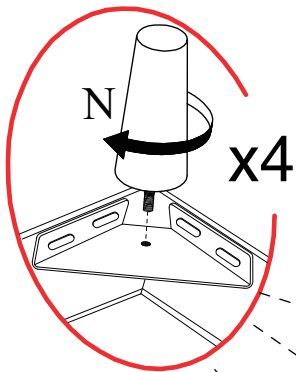

# Step 8

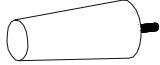

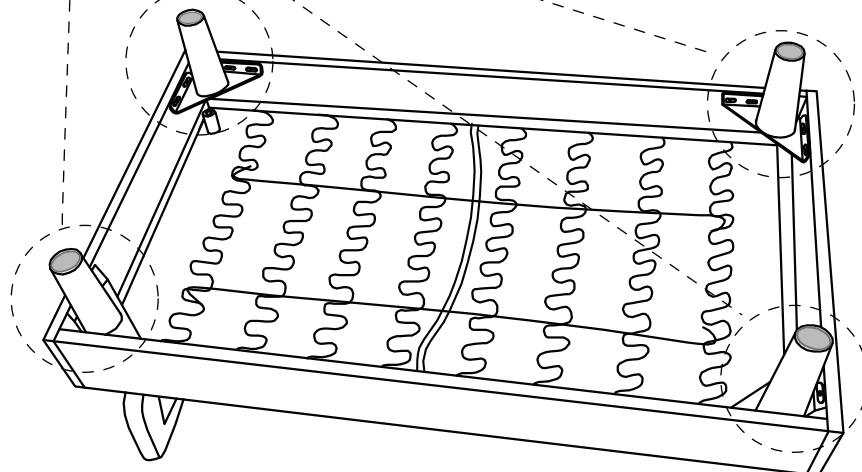

	
N*4	T*4

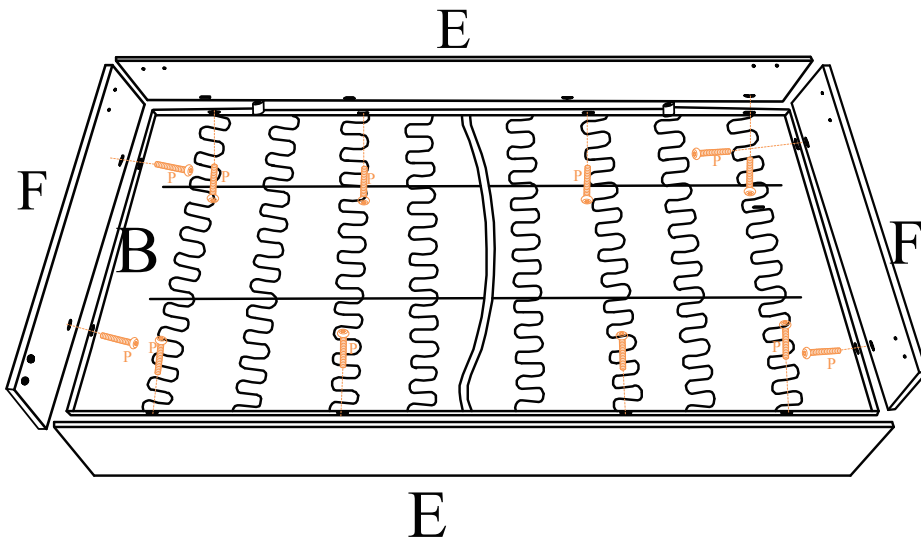

# Step 9



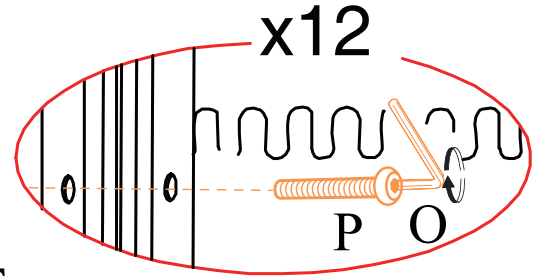

	
M6	8*45mm
O*1	P*12

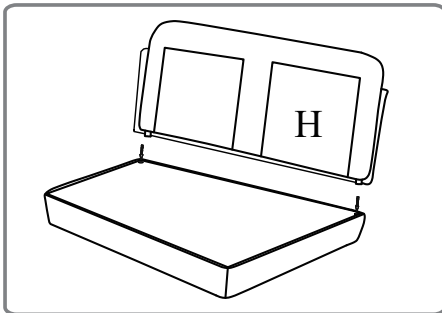

# Step 10



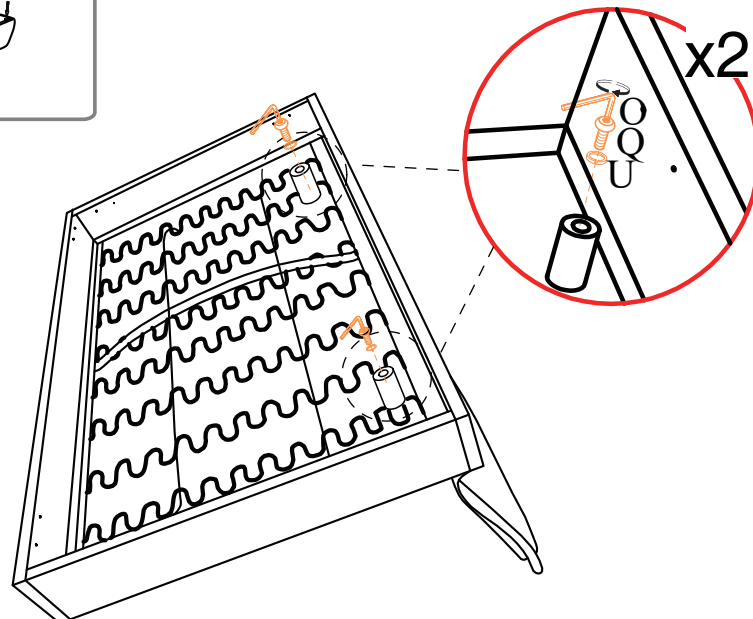

		
M6	8*20mm	
O*1	Q*2	U*2

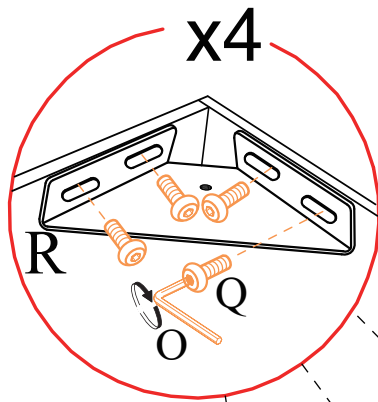

# Step 11



		
R*4	O*1	Q*16

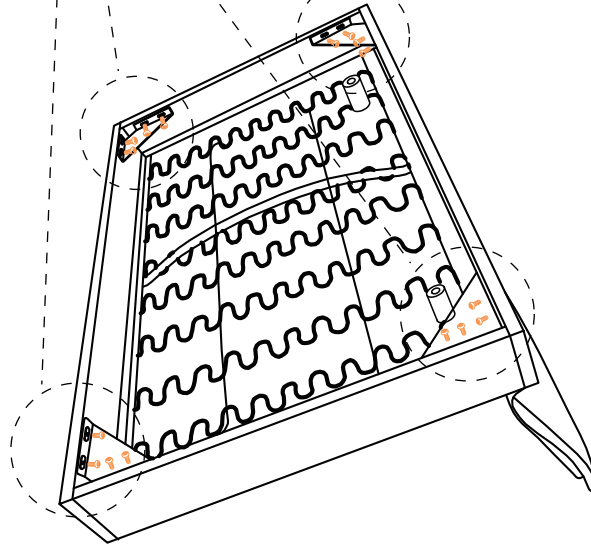

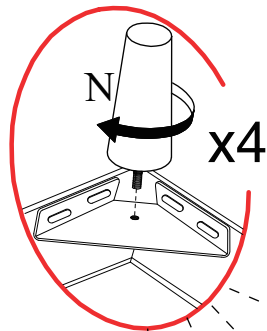

# Step 12

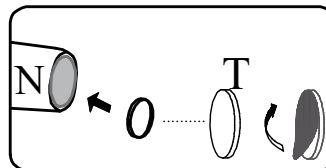

Apply felt pads.

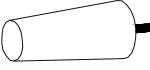

	
N*4	T*4

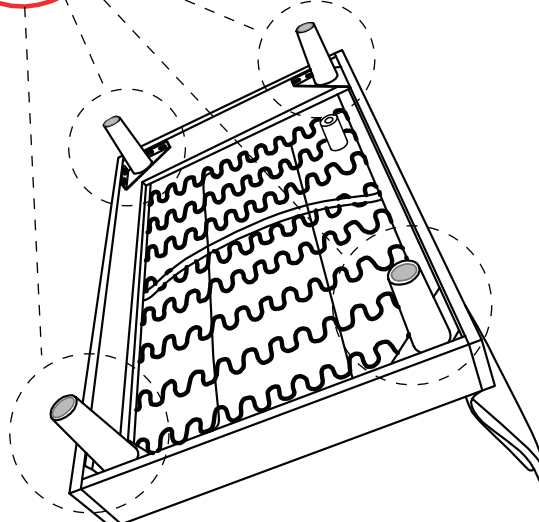

# Step 13

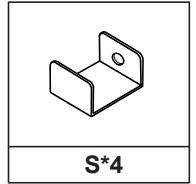
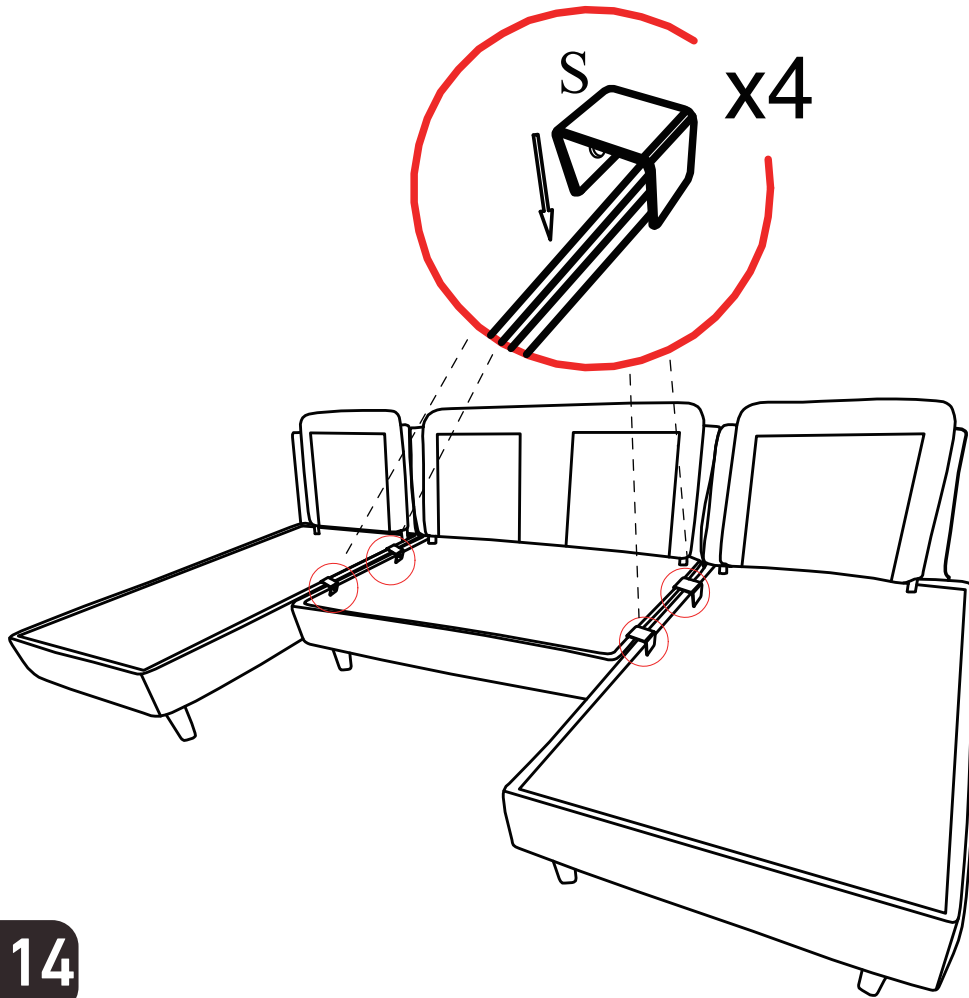

# Step 14

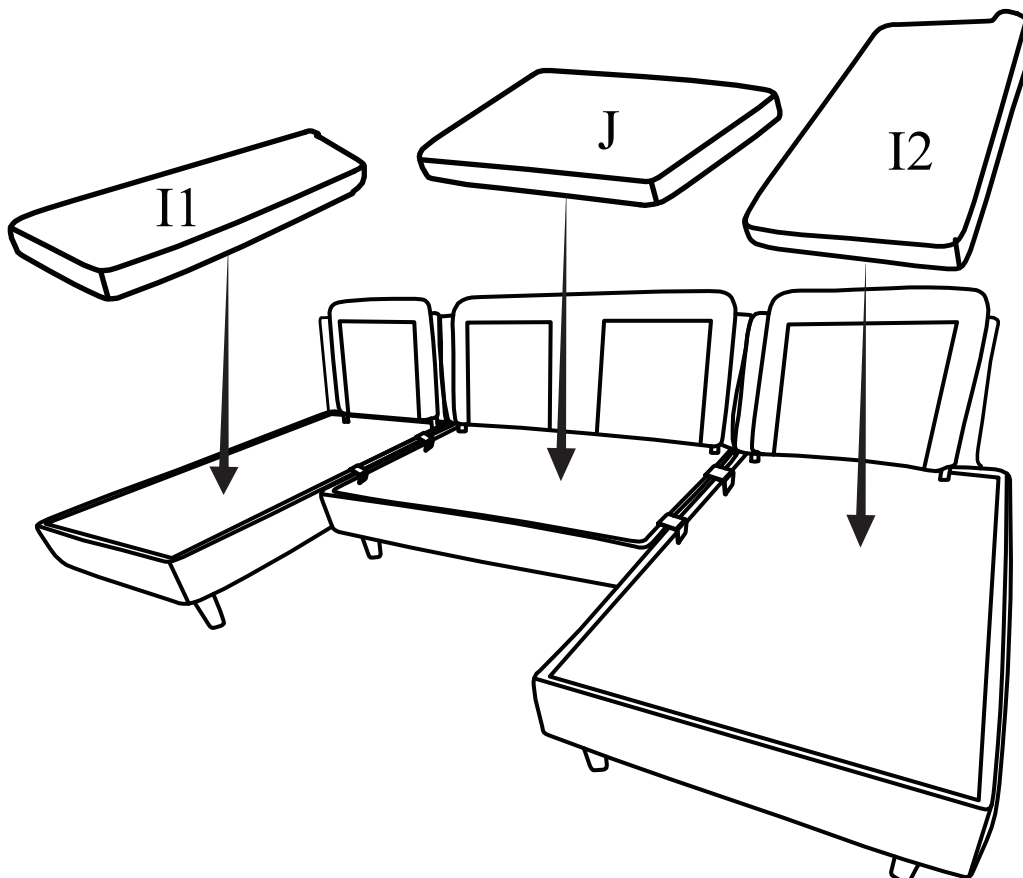

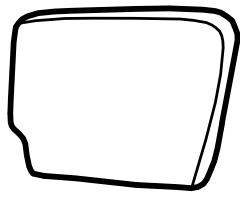

Pat the back cushion/armrest cushion 3 times along with longitude direction

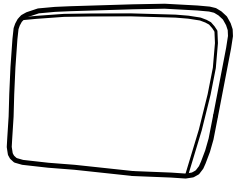
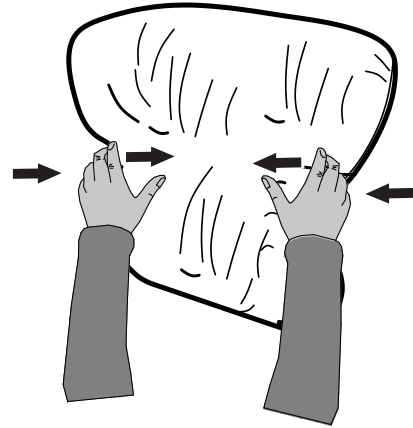
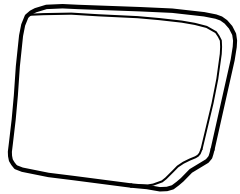

Pat the back cushion/armrest cushion 3 times along with latitude direction

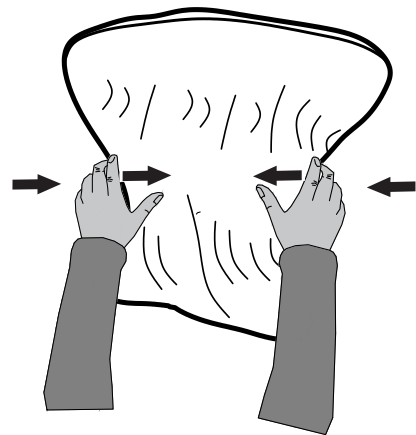

Pat the back cushion/armrest cushion surface 3 times

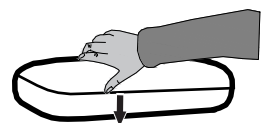
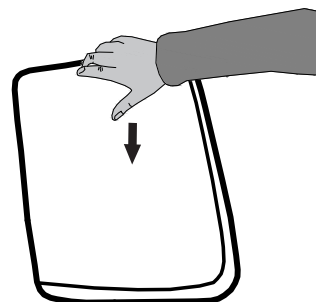
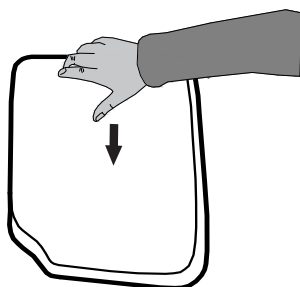
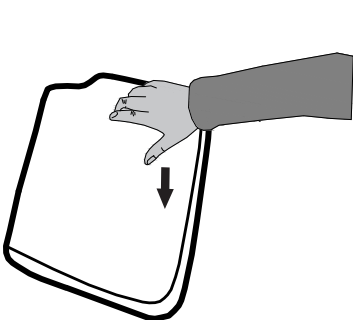

## Step 15

---

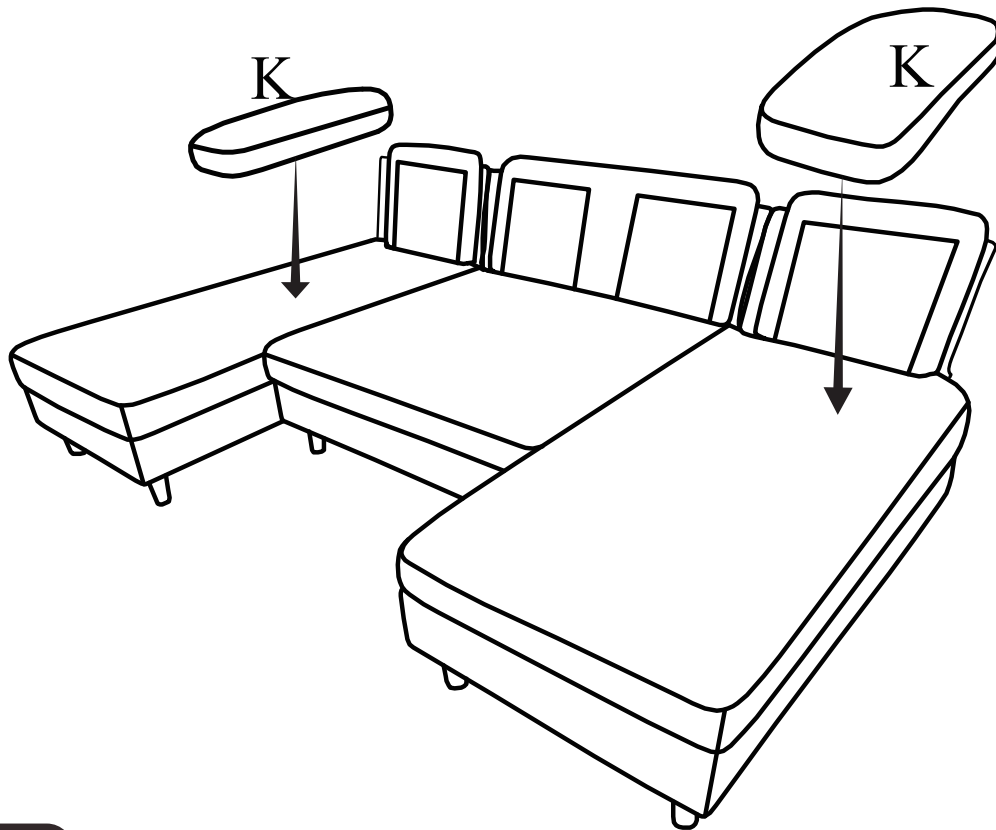

## Step 16

---

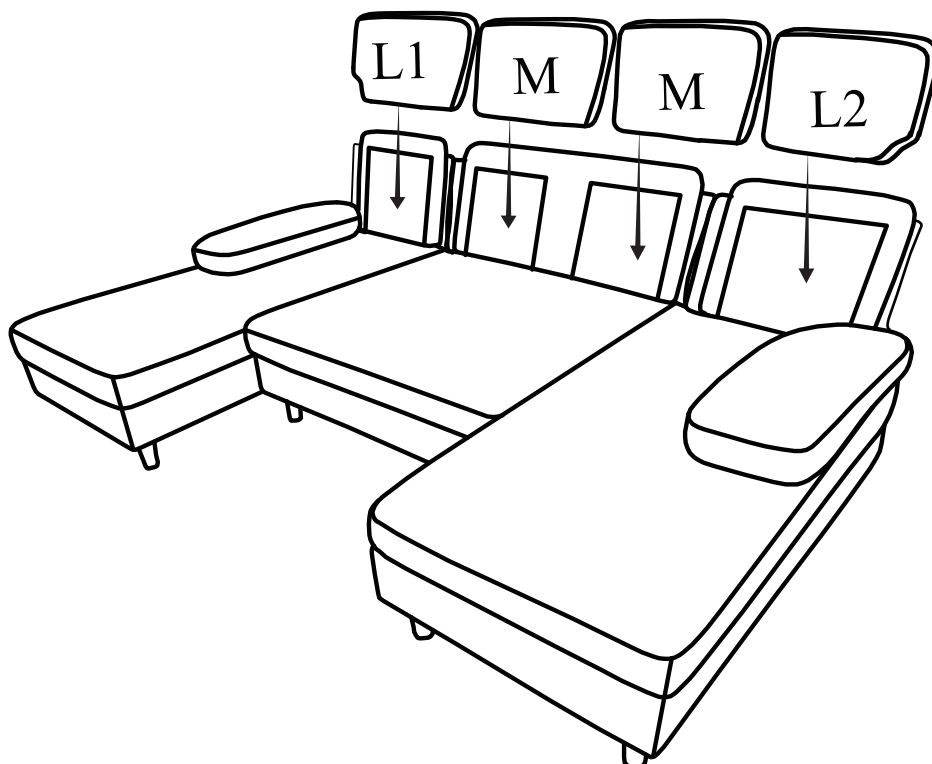

## Step 17

---

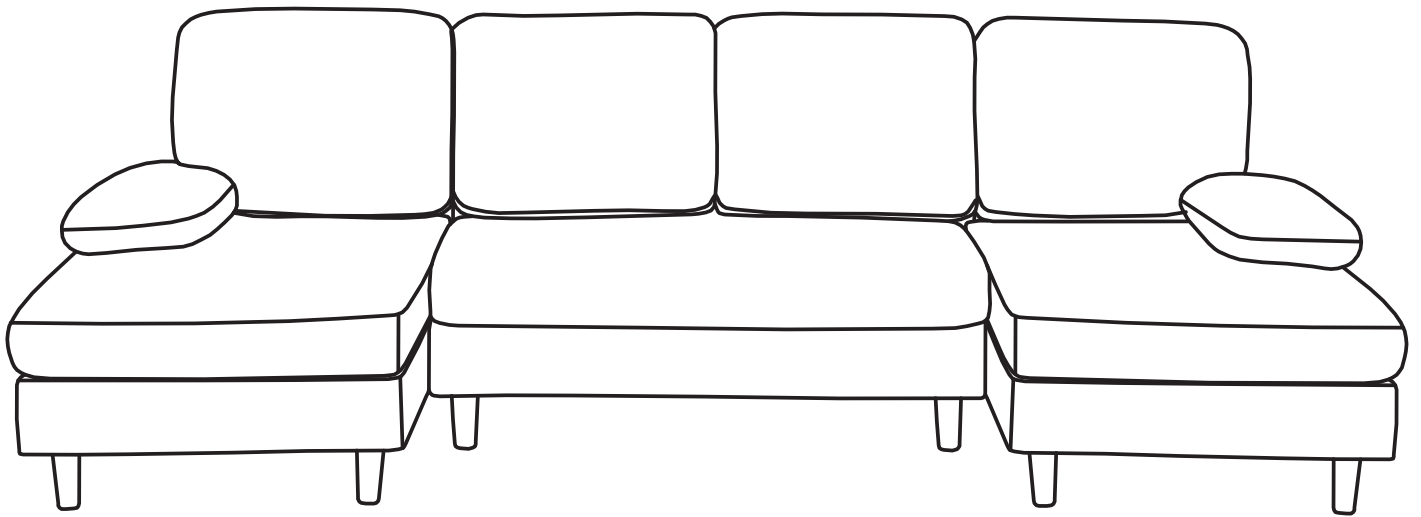

### **Note:**

After assembly, there may be visible compression marks on the surface. Gently pat the affected areas and allow the sofa to rest for 1-2 weeks. The surface will gradually return to its original shape.

