

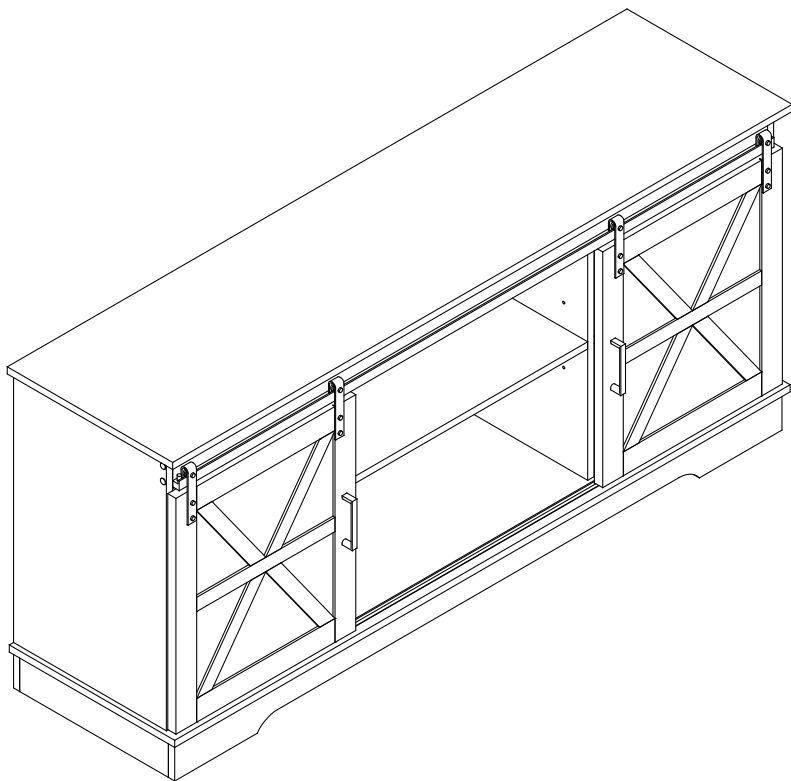



DGYJH-V4









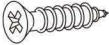
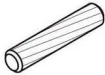

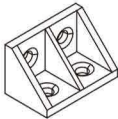
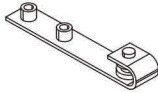
FTLFTS-0005  
FTLFTS-6003  
FTLFTS-6046

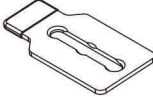
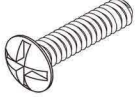
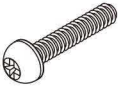

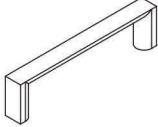

Notice:

1. Follow the installation instructions. Please confirm all accessories are preset before installation.
2. Do not fully tighten the screws during initial assembly. Fully tighten screws only once all pieces which are correctly assembled.
3. If you encounter any problems during installation, refer to two solutions: Follow the installation video tutorial on the Amazon product page or contact our customer service.

Item no.	Reference Image	Qty.	Item no.	Reference Image	Qty.
Ⓐ		× 34	Ⓓ	 M7×48	× 12
Ⓑ		× 34	Ⓔ	 M3.5×14	× 32
Ⓒ	 ∅8×30	× 24			

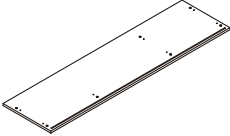
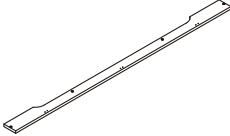
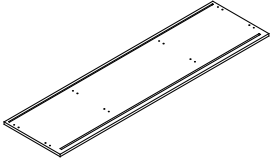
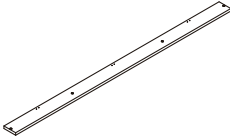
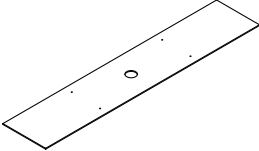
Item no.	Reference Image	Qty.	Item no.	Reference Image	Qty.
Ⓒ		×6	Ⓕ		×4
Ⓓ		×8	Ⓖ		×4
Ⓔ	 M6×25	×4	Ⓗ	 M4*25	×4
Ⓙ	 M6×18	×8	Ⓖ		×2
Ⓚ		X10	Ⓟ		×4
Ⓡ		X10	Ⓠ		×4
			Ⓡ		-

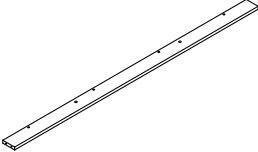
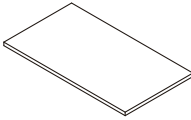
Item no.	Reference Image	Qty.	Item no.	Reference Image	Qty.
1	 1500x400x15mm	×1	5	 1472x78x15mm	×1
2	 1490x400x15mm	×1	6	 1472x78x15mm	×1
3	 1450x290x5mm	×2	7	 1472x78x15mm	×1
4	 1440x69x15mm	×1	8	 597x330x15mm	×1

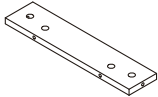
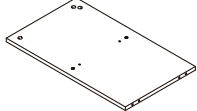
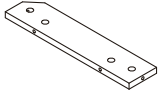
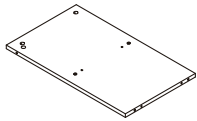
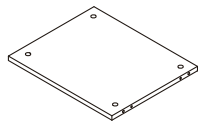
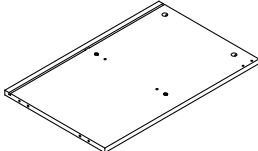
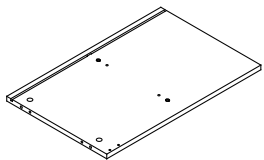
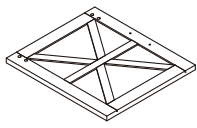
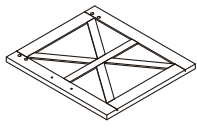
Item no.	Reference Image	Qty.	Item no.	Reference Image	Qty.
9	 355x78x15mm	×2	13	 570x333.5x15mm	×1
10	 355x78x15mm	×2	14	 570x333.5x15mm	×1
11	 405x332.5x15mm	×2	15	 570x370x15mm	×1
12	 570x370x15mm	×1	16	 496x436x20mm	×1
			17	 496x436x20mm	×1

# Explosion Diagram

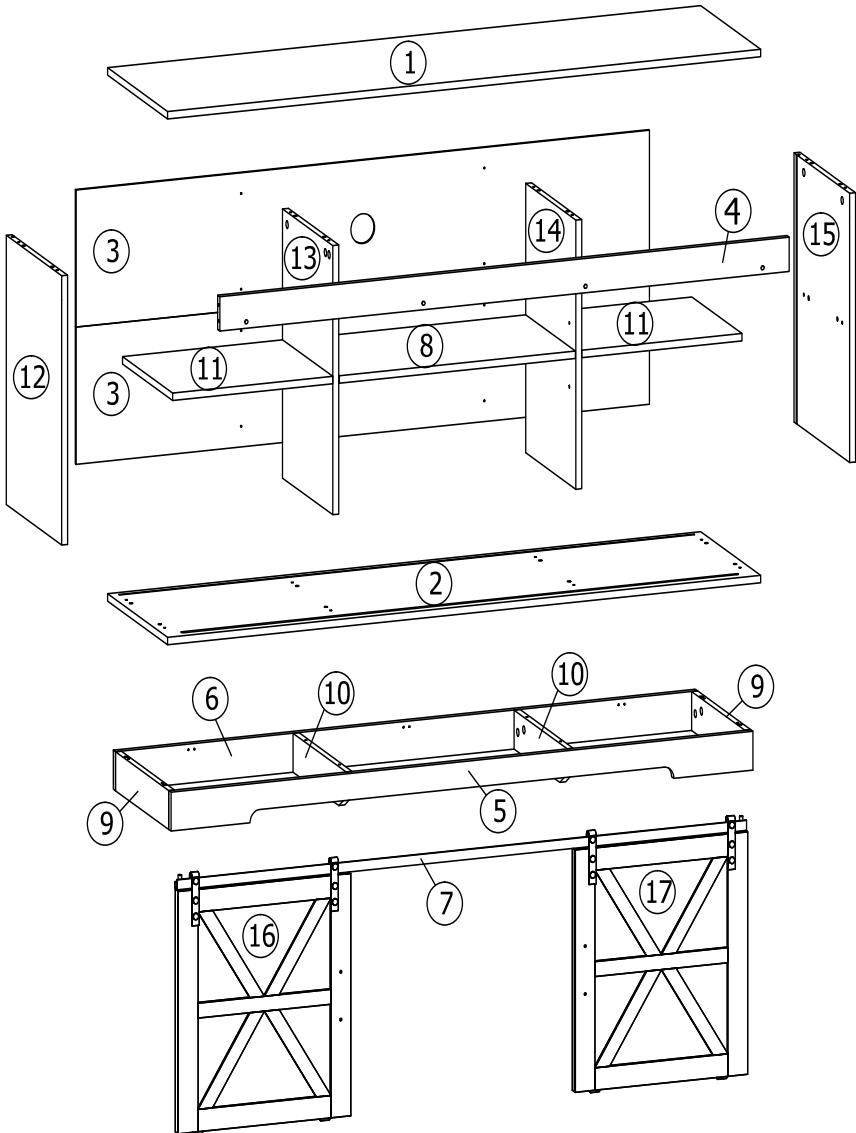

## How to use the cam lock system

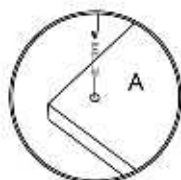

1. Screw cam bolt into panel

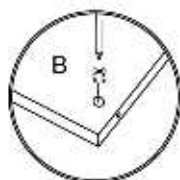

2. Push cam into panel - arrow feature on cam top points to panel edge

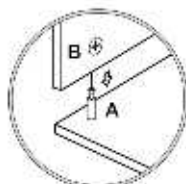

3. Align cam bolt(s) with cam(s) and insert all the way into cross-bored hole(s)

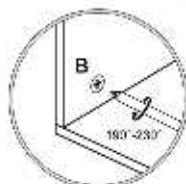

4. Rotate cam(s) clockwise 190°-230° to lock panels together

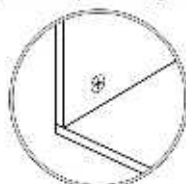

5. Panels should be tight against each other and connection should be rigid

Insert the wood dowel [C] at least half way by tapping lightly with a rubber mallet, IF NECESSARY.

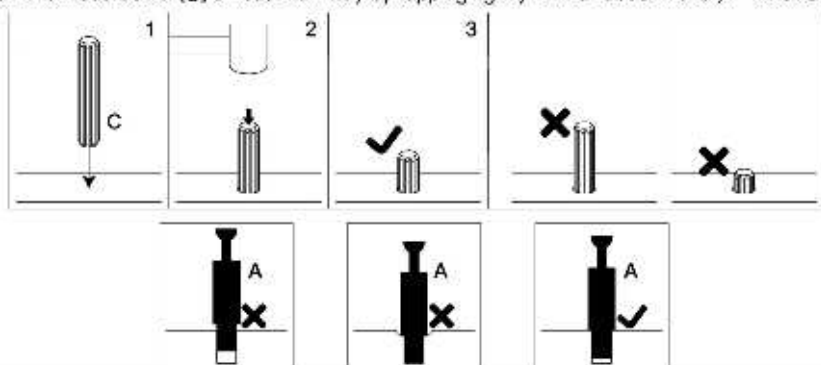

### **⚠ WARNING**

- Unit must be placed on a level surface or leveled with included hardware (when applicable).
- Do not sit or stand on or allow children to climb, sit or stand on the assembled product.
- For safety reasons, it is imperative that this unit be mounted to the wall.
- Do not use without installing the tip restraint.
- Unit can tip over causing severe injury or death.
- Do not exceed the recommended weight limits.
- Evenly distribute the weight on each level and always keep the heavier loads on the bottom.
- Before cutting, drilling or hammering into any wall or floor surface, verify the location of electrical, plumbing and gas lines. Cutting may cause serious injury.

# 1

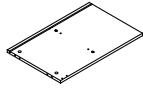

⑫ 1PCS

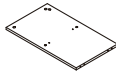

⑬ 1PCS

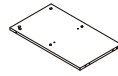

⑭ 1PCS

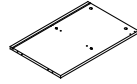

⑮ 1PCS



Ⓐ 8PCS

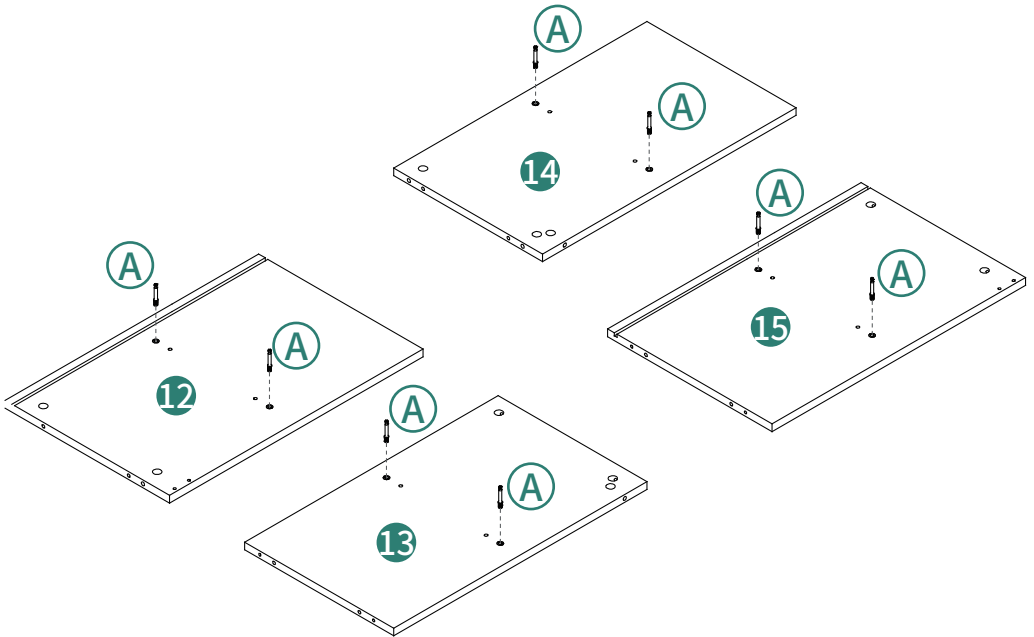



# 2

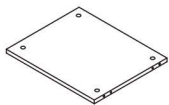

① 2PCS



② 8PCS

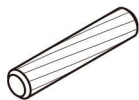

③ 8PCS

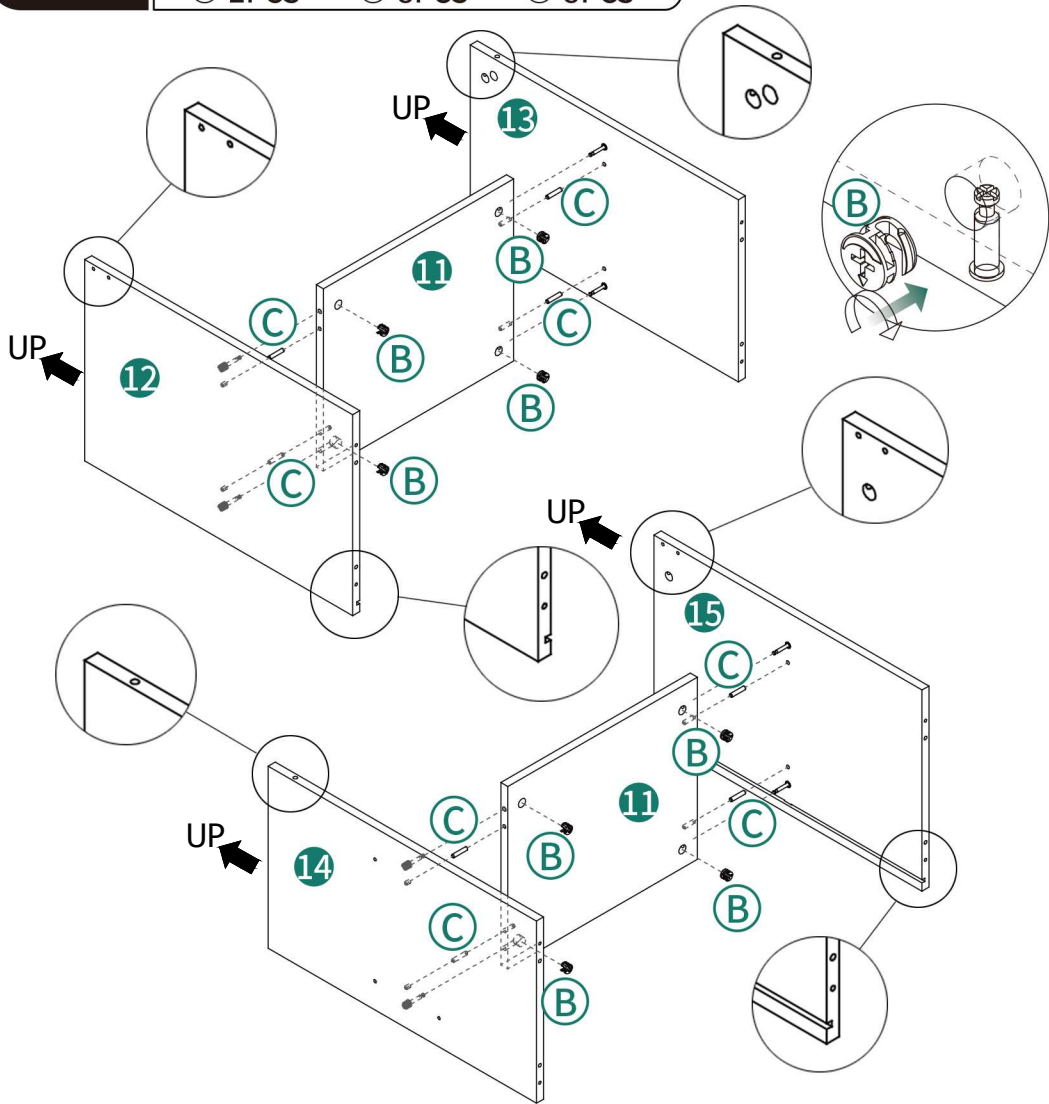

3



① 1PCS



Ⓐ 8PCS

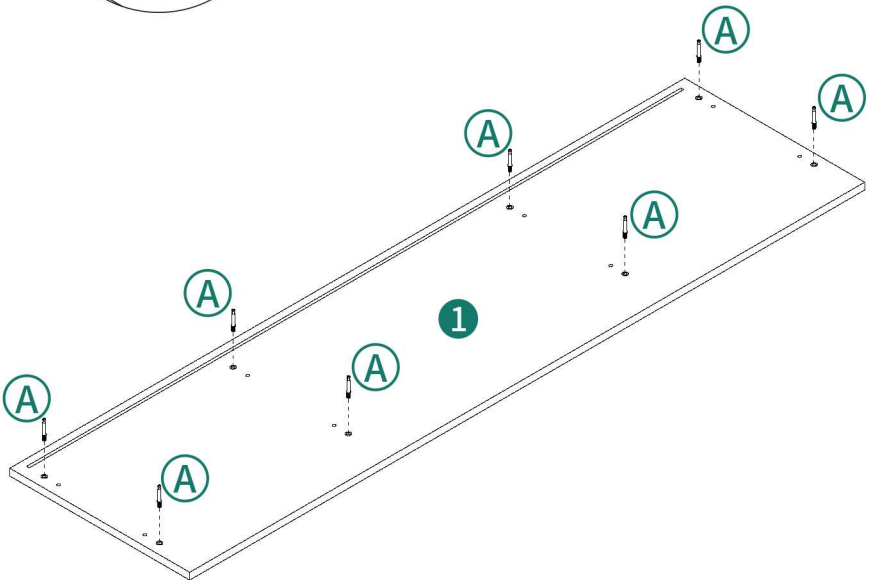
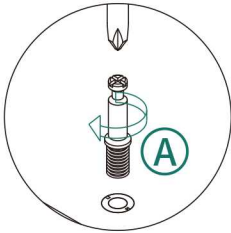

# 4



Ⓑ 8PCS

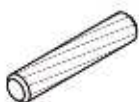

Ⓒ 8PCS

Backboard slot at the back

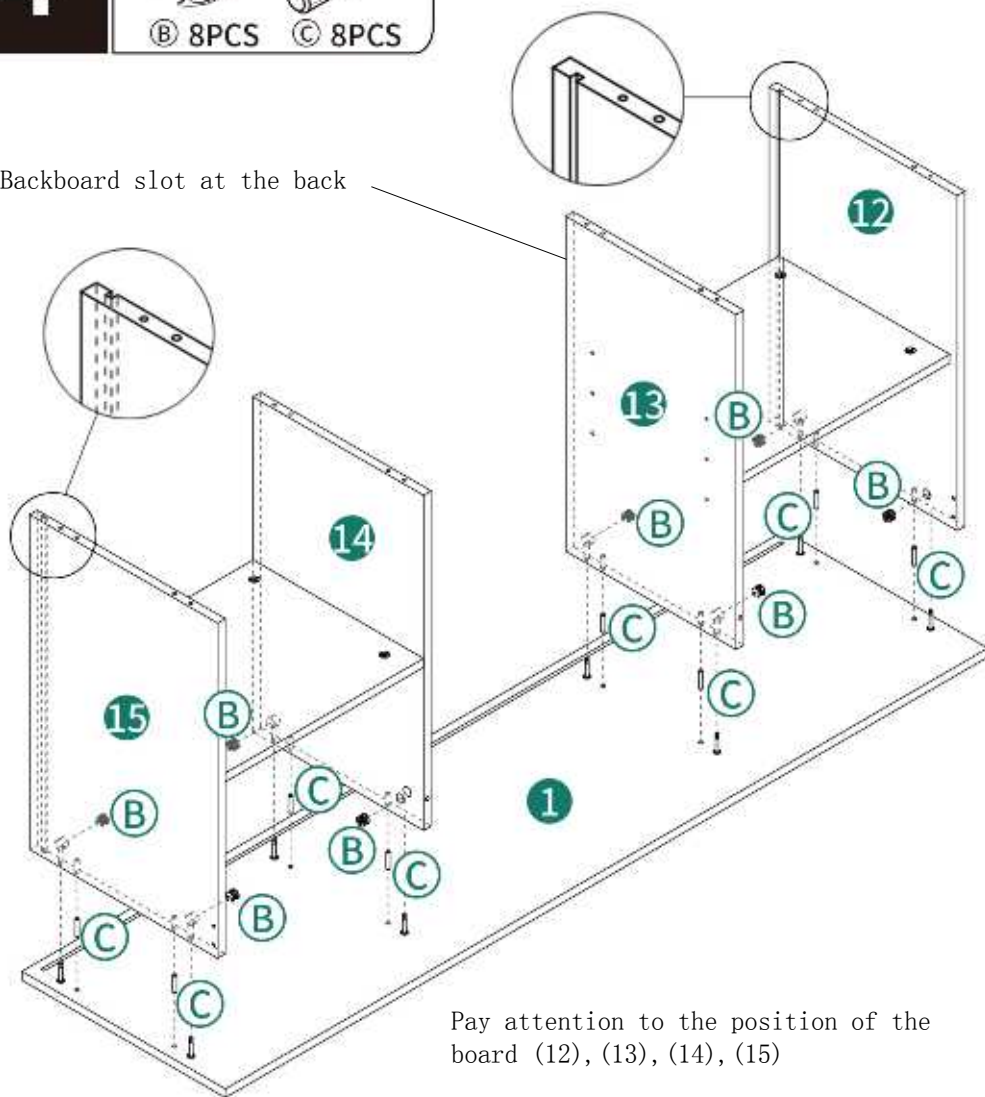

Pay attention to the position of the board (12), (13), (14), (15)

# 5



④ 1PCS



⑦ 1PCS



Ⓐ 2PCS



Ⓑ 2PCS



① 4PCS

STEP 5-1



STEP 5-2

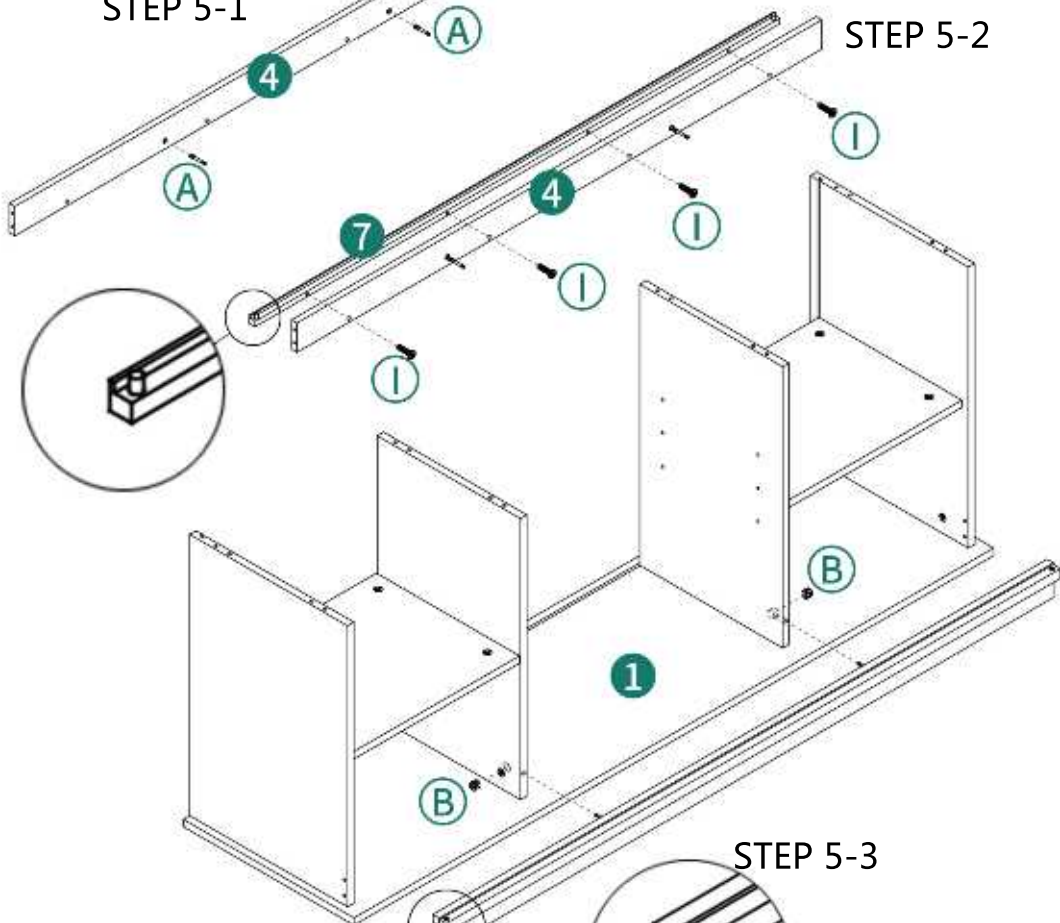

STEP 5-3

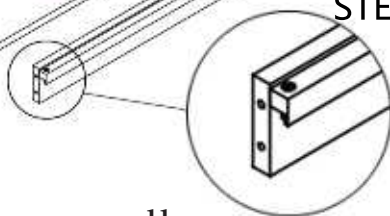

6

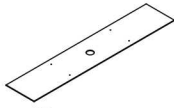

③ 2PCS



ⓓ 4PCS

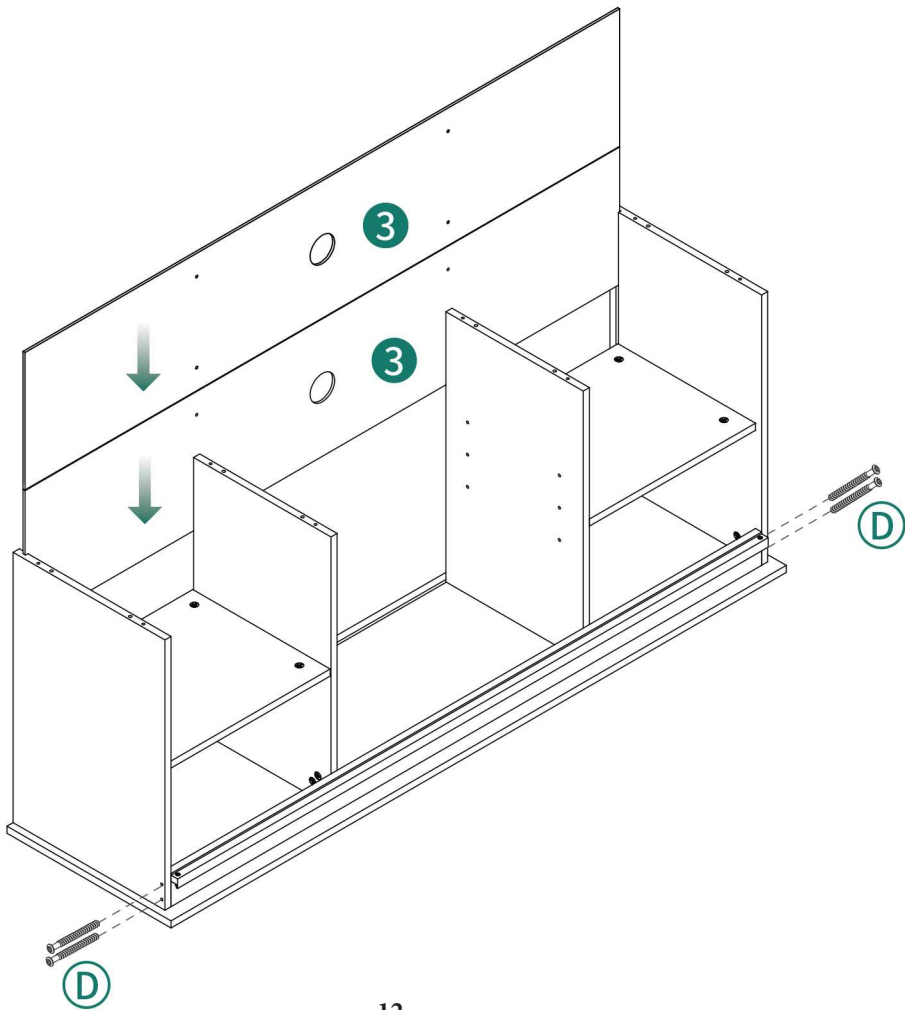

7

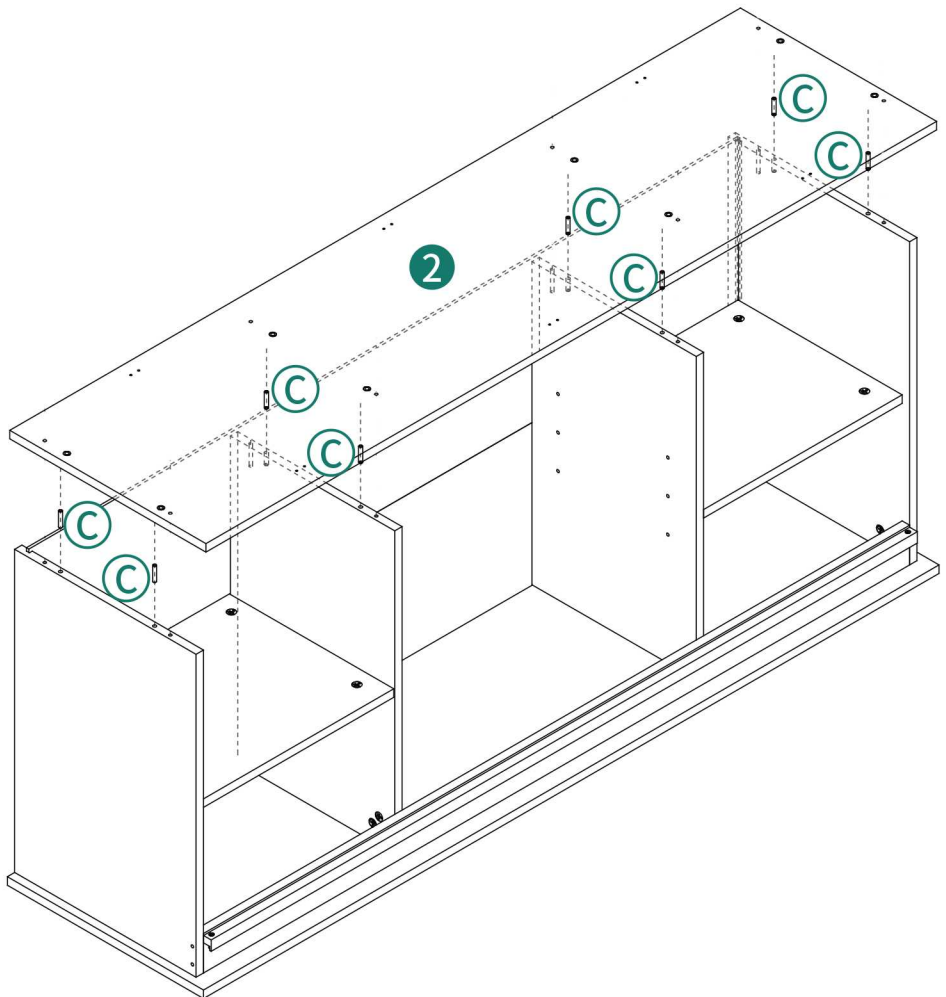
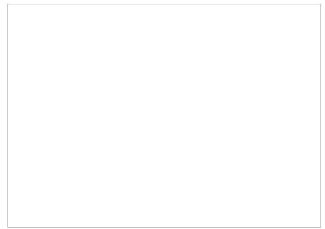
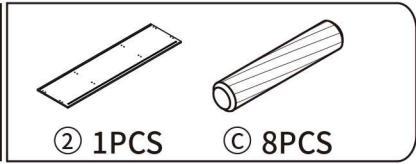

8

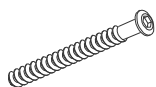

ⓓ 8PCS

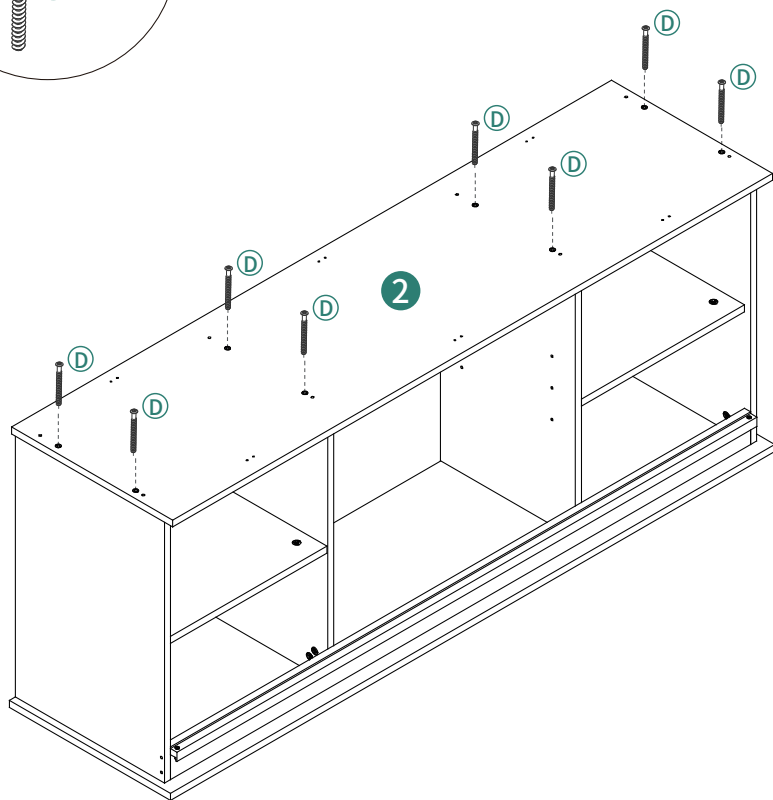
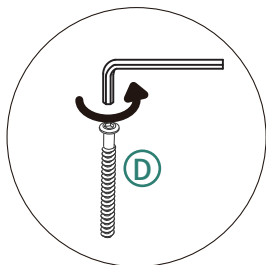

9



⑤ 1PCS



⑥ 1PCS



Ⓐ 16PCS

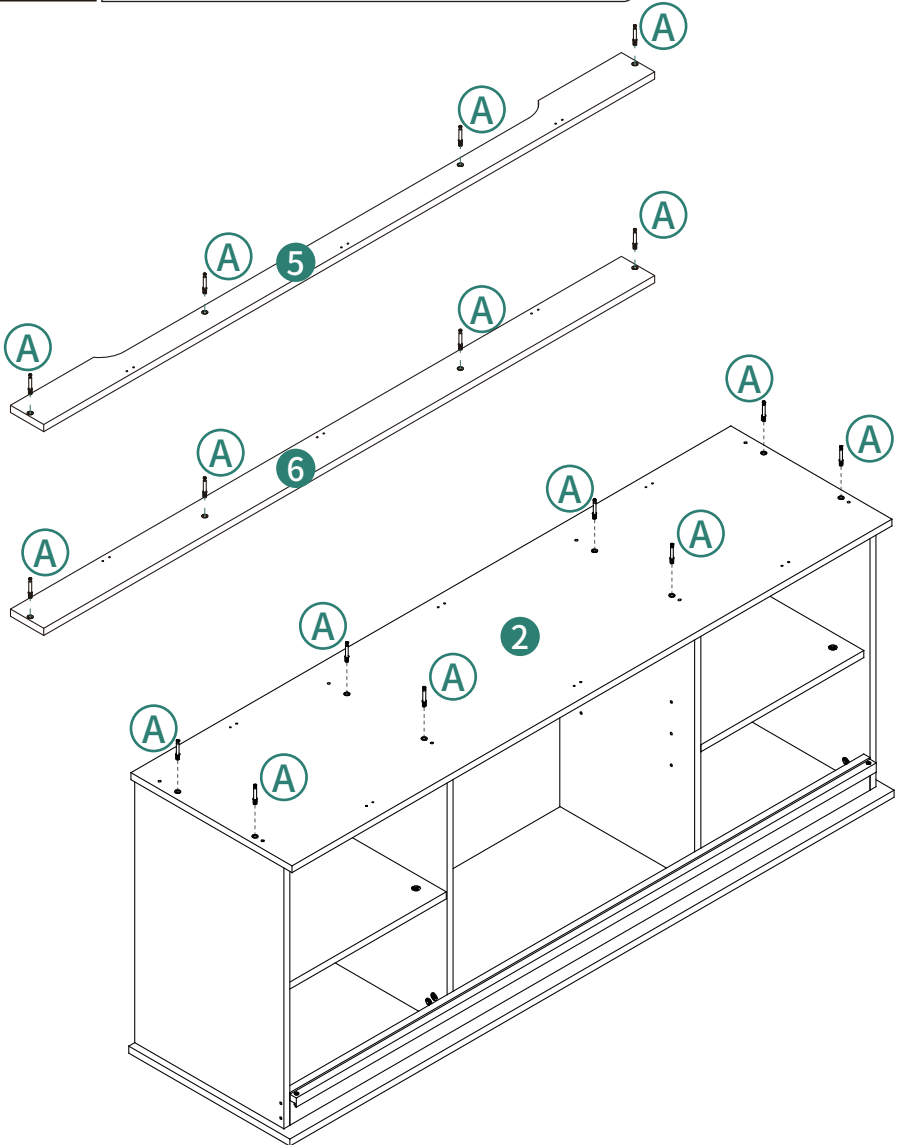



# 10

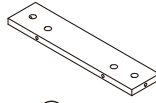

⑨ 2PCS

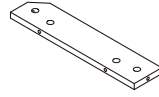

⑩ 2PCS



Ⓑ 8PCS

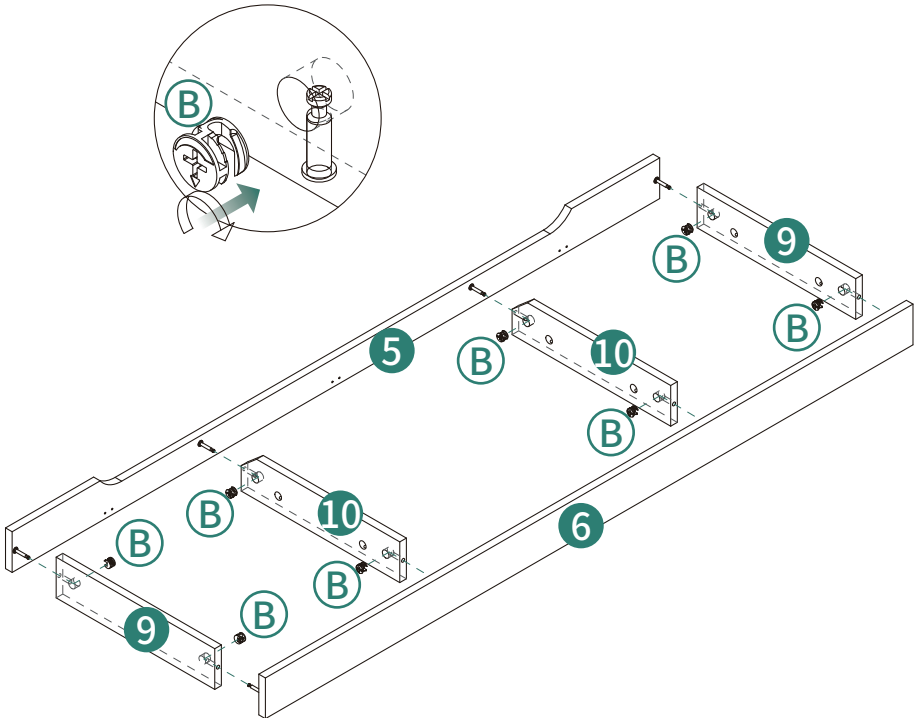

11



Ⓑ 8PCS

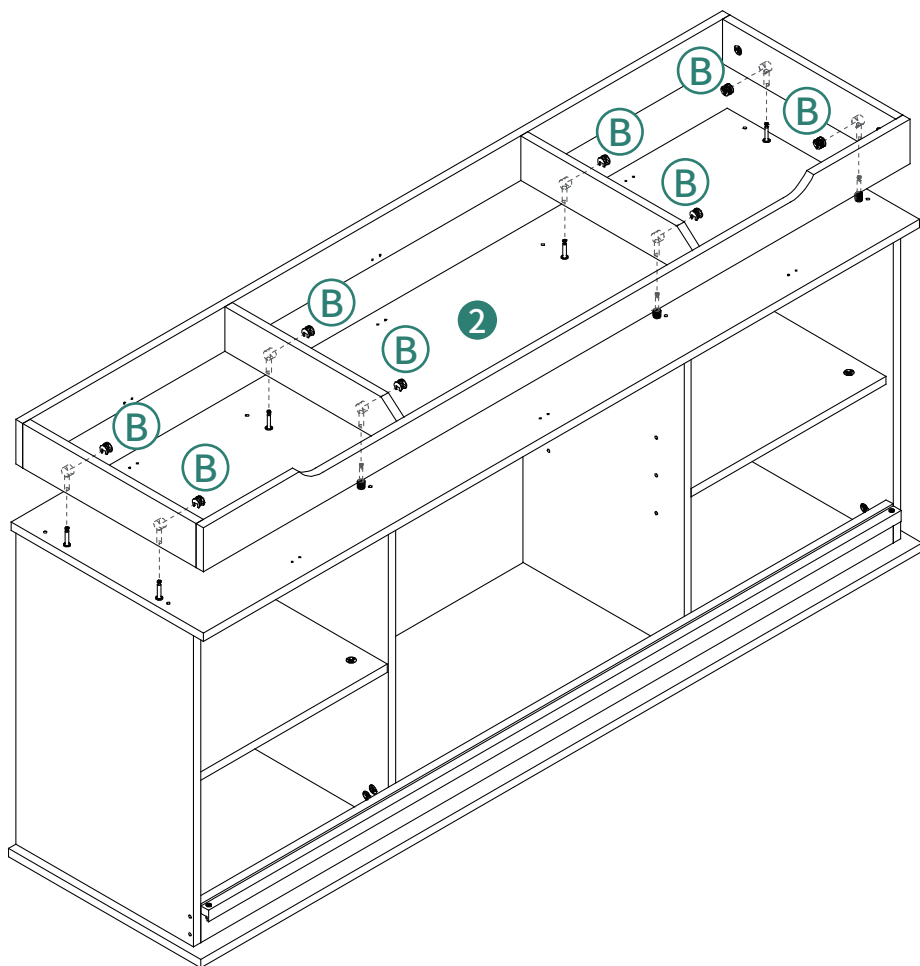

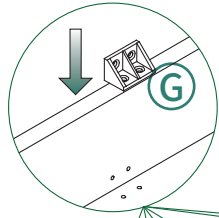

**12**

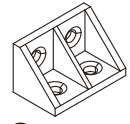

ⓐ 6PCS

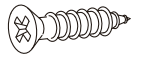

ⓔ 24PCS

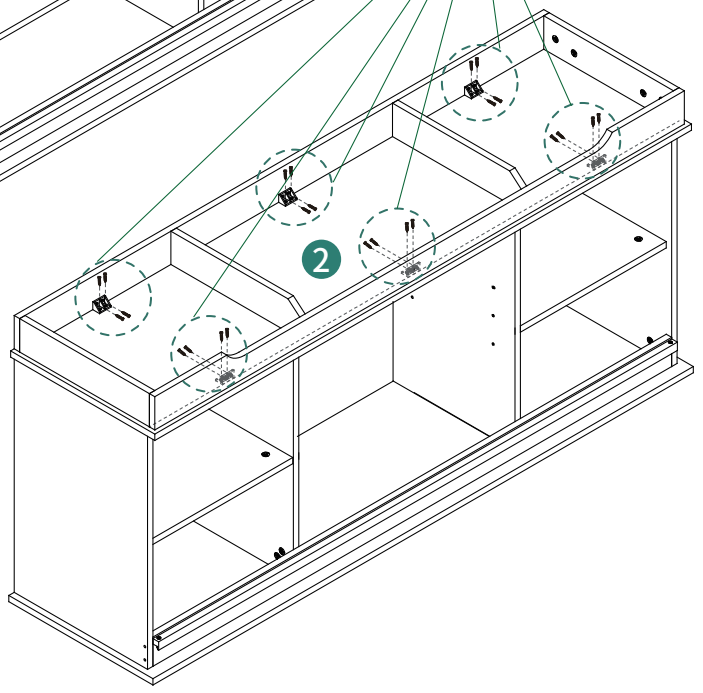
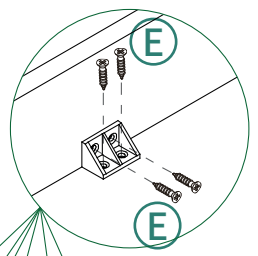
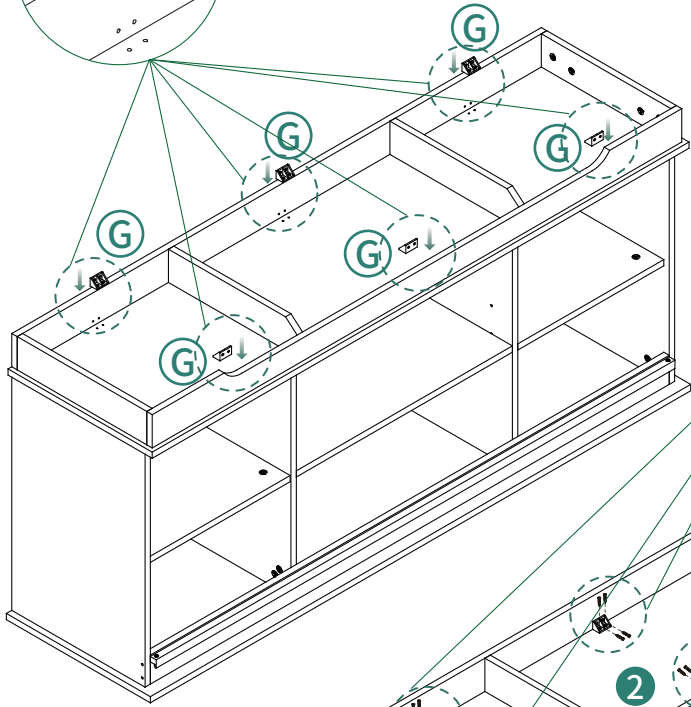

# 13

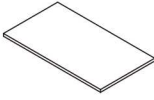

⑧ 1PCS



⑨ 4PCS



⑩ 4PCS

Turn over

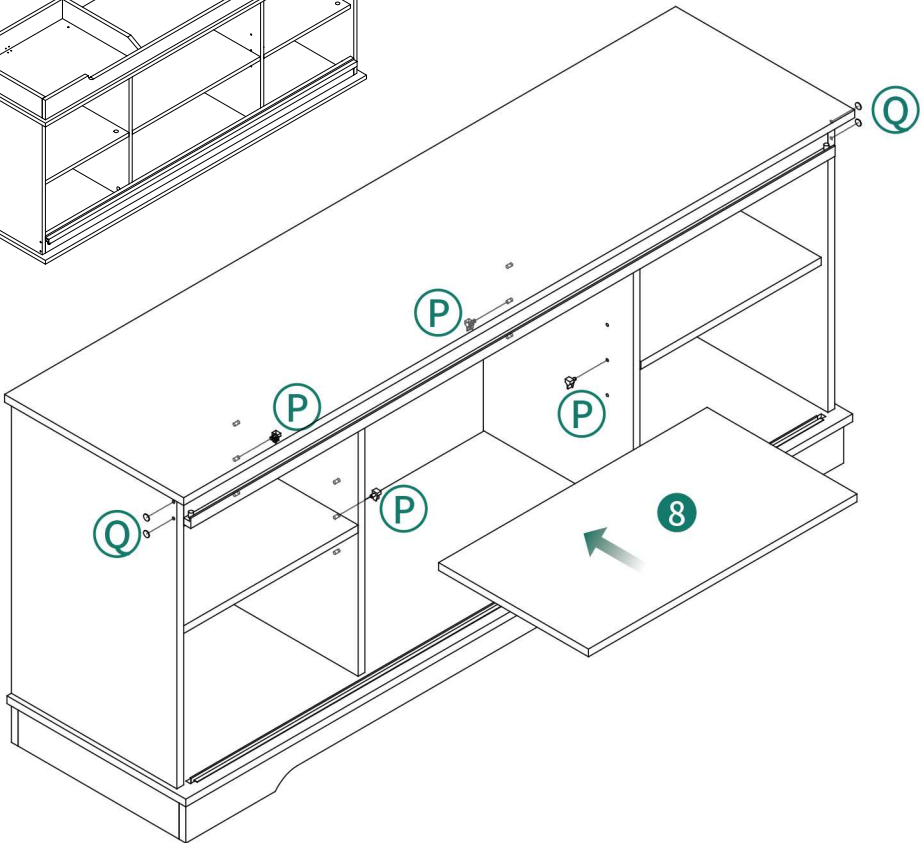
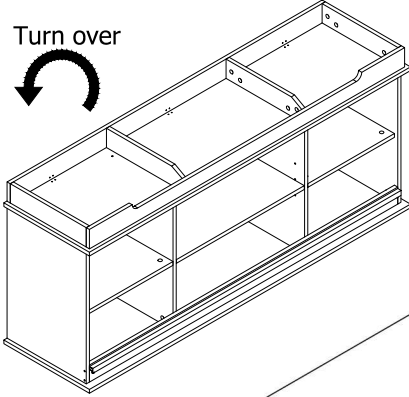

14



Ⓜ 8PCS

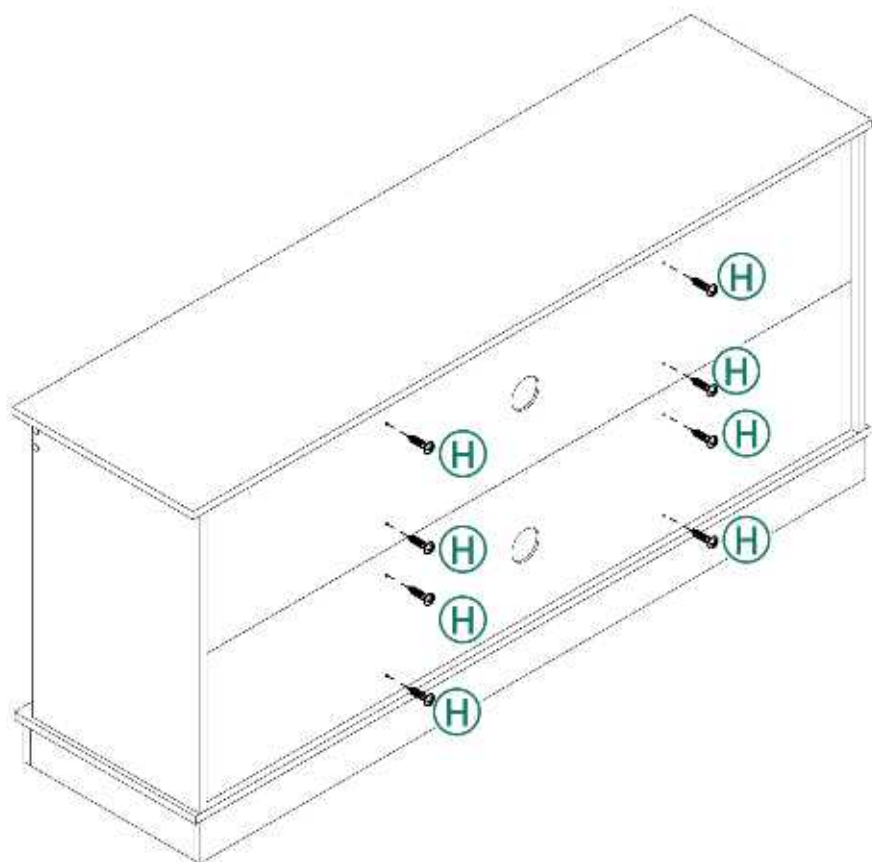

# 15



M3x16



Ⓚ10PCS

Ⓜ10PCS

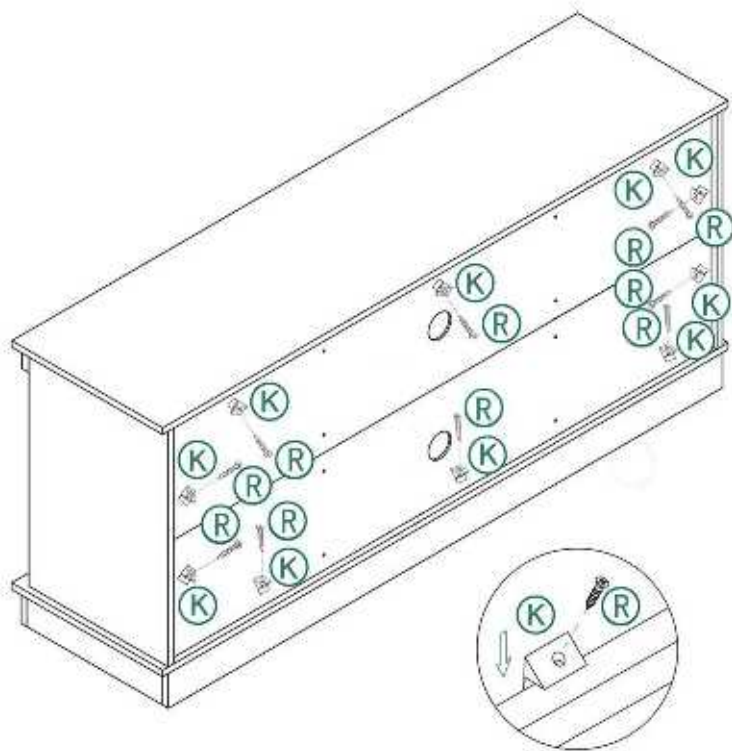

# 16

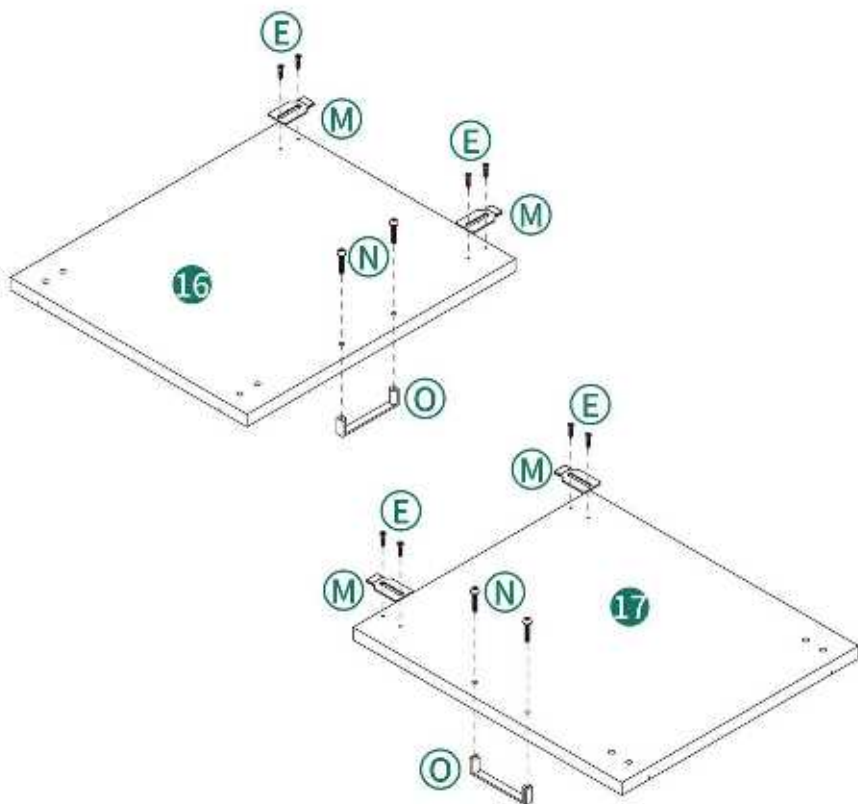
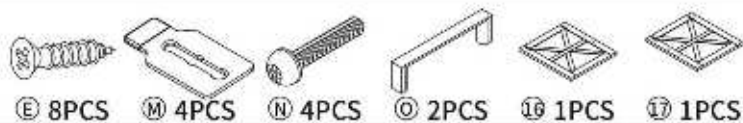

# 17



ⓐ 8PCS

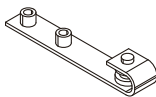

Ⓛ 4PCS

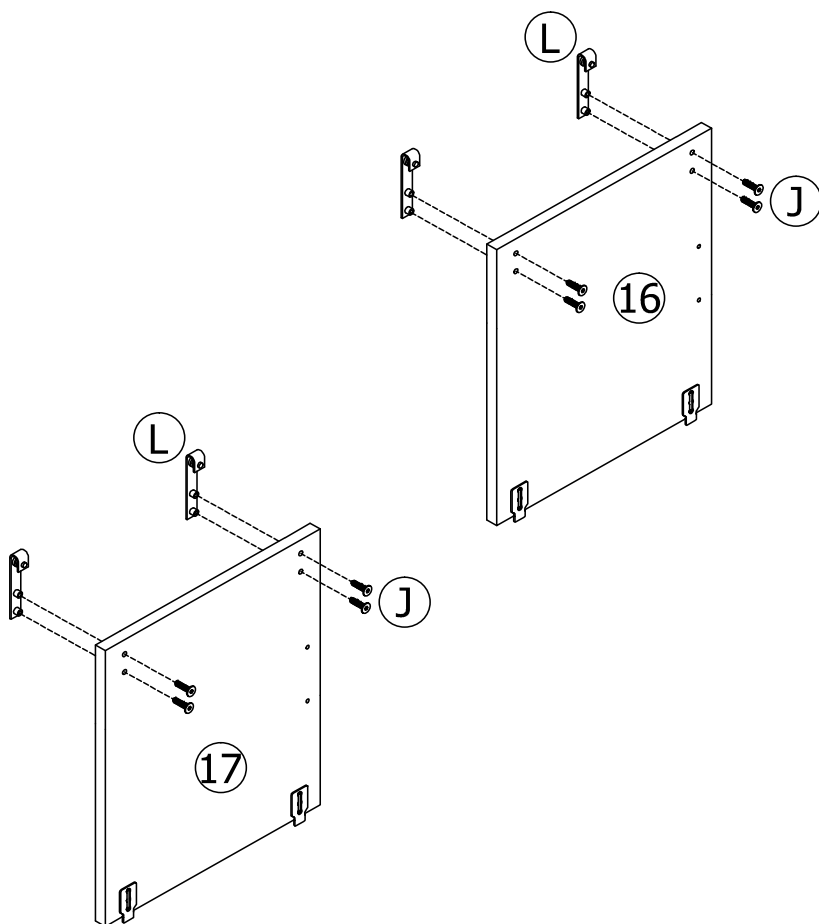



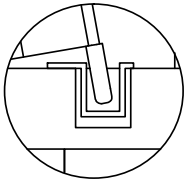

steps 1

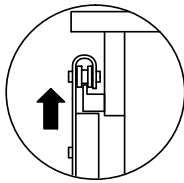

steps 2

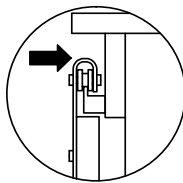

steps 3

steps 2

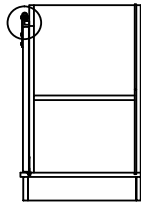

steps 1

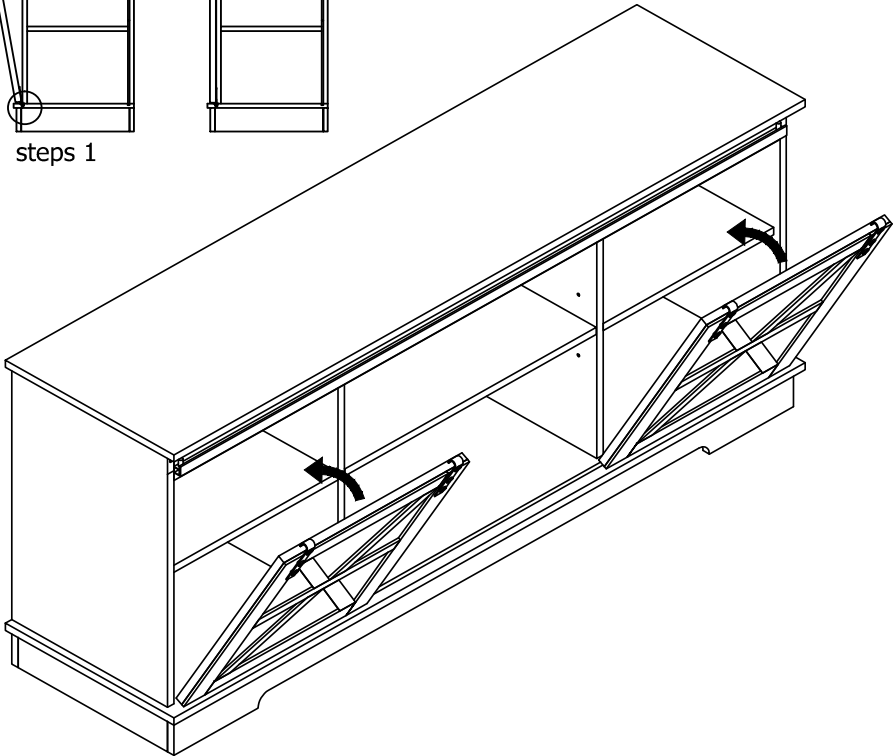
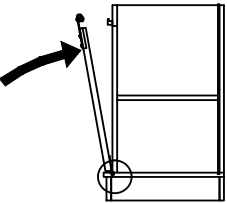

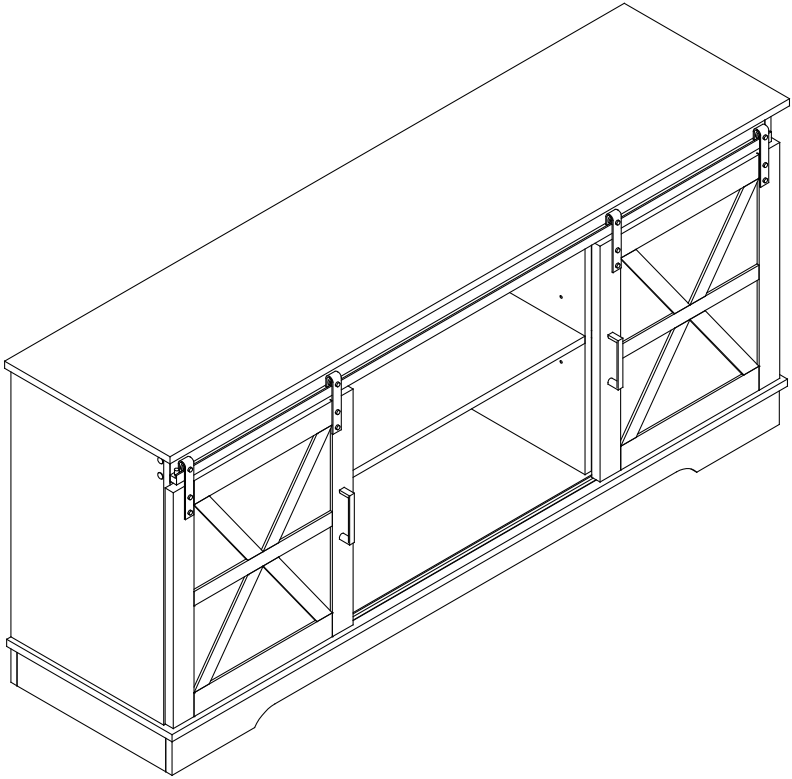

**Installation Completed**