

# OUTDOOR WALL LANTERN USE AND CARE GUIDE

Motion Sensor: S306S.VR V6.1A  
GFCI: V1.0

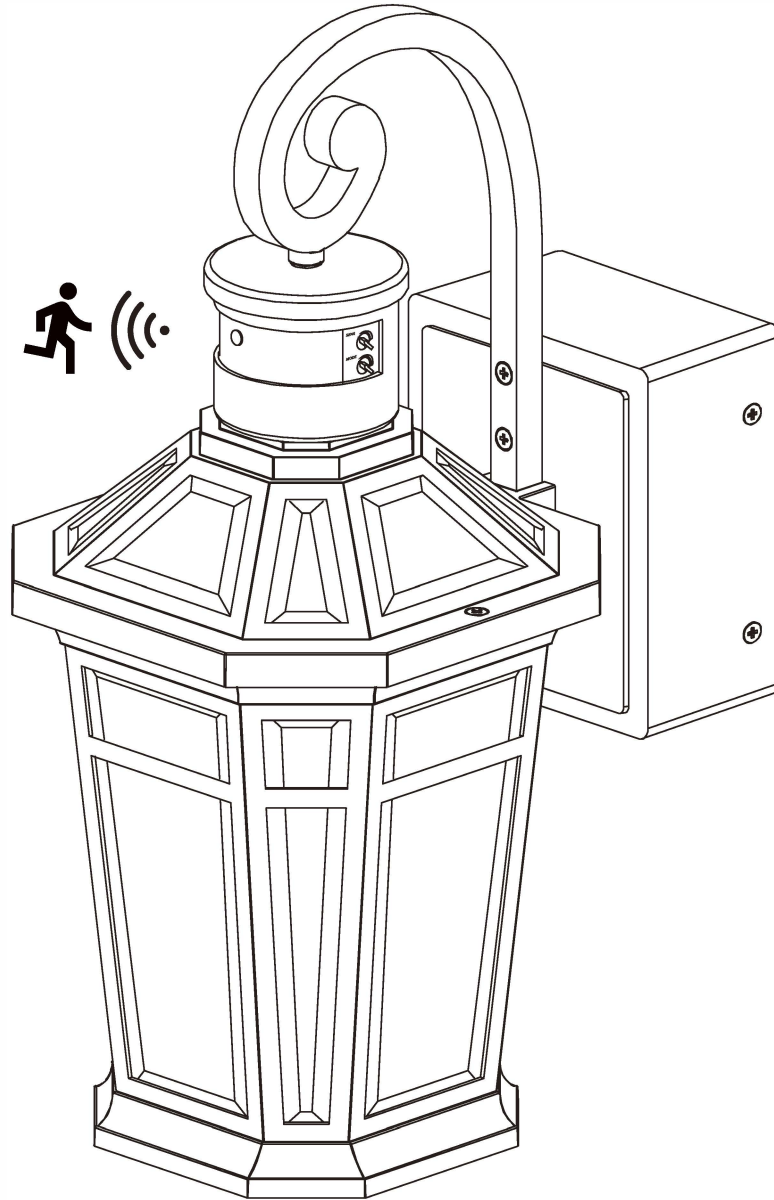

# INSTALLATION INSTRUCTIONS FOR OUTDOOR WALL LIGHT



INSTRUCTIONS PERTAINING TO RISK OF FIRE OR INJURY TO PERSONS  
READ ALL INSTRUCTIONS

**IMPORTANT SAFETY  
INSTRUCTIONS**  
SAVE THESE INSTRUCTIONS

**Before starting the installation, disconnect the Power by Turning Off the Circuit Breaker.** Turning the Power Off using the Light Switch is not sufficient to prevent electrical shock. All electrical connections and installation must be following local codes, ordinances, and/or National Electric Code and Must Be Done by an Electrician Only.

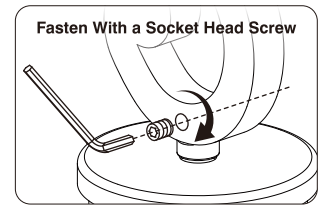
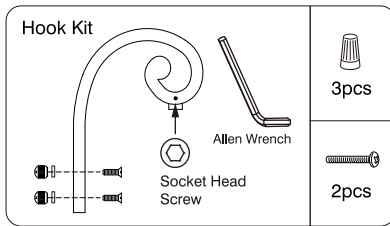

Fasten With a Socket Head Screw

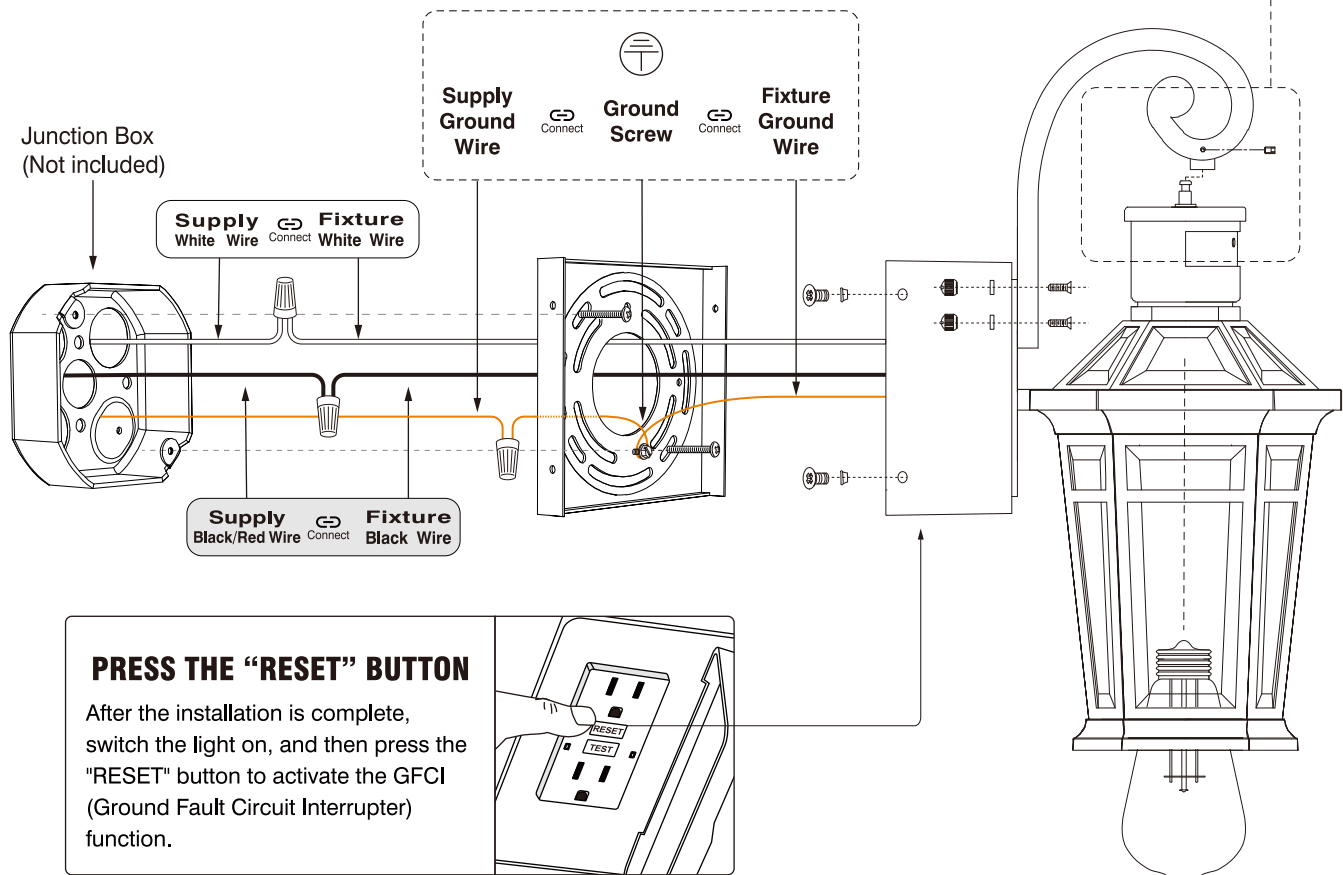

## WIRE NUT USAGE STEPS:

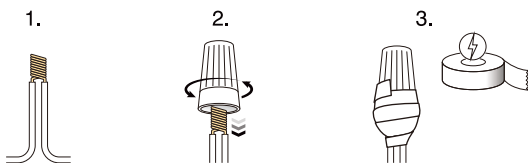

## E26 DIMMABLE BULBS

Please use DIMMABLE LED bulbs to be well compatible with the wall lantern and avoid flicker problems. Supports up to 100W power. (Bulbs not included)

## INSTALLATION NOTES:

Please note: This lamp cannot be installed on any dimmer switch. Using a dimmer switch will damage the sensor circuit of this lamp.

When installed in dim or shaded areas, during winter, or in low-light conditions, the lamp might not switch off automatically. Please manually turn off the lamp when necessary.

# ASSEMBLY INSTRUCTIONS

## TOOLS AND MATERIALS REQUIRED:



Phillips  
Screwdriver



Wire Cutters



Safety Gloves



Ladder

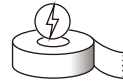

Electrical Tape

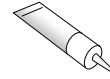

Mastic Silicone  
Rubber



Safety Glasses

## INSTALLATION:

Note: the product may not look exactly as shown in the figures.

Please install the light fixture in the correct orientation as shown in the diagram. Damage caused by incorrect installation, resulting in water ingress, is not covered by the warranty.

<p><b>1</b></p> <p>Mounting Bracket</p> <p>Junction Box (Not included)</p>	<p>Remove the Mounting Bracket from the Fixture and attach it to the Junction Box with 2 screws.</p>	<p><b>4</b></p> <p>Fixture</p> <p>Screws</p>	<p>Install the other accessories (if any), then secure the fixture to the mounting bracket with 4 screws</p>
<p><b>2</b></p> <p>Ground Screw</p>	<p>Connect the white wire of the fixture to the white wire of the power supply. Connect the black wire of the fixture to the black wire of the power supply (or to the red wire of the power supply). Fix the ground wire with ground screw and then connect it to the power supply ground wire (See page 1 for detailed illustrations)</p>	<p><b>5</b></p>	<p>Install a <b>dimmable bulb</b> with appropriate wattage. LED bulbs are recommended for better compatibility with the wall light. (Bulb not included.)</p>
<p><b>3</b></p> <p>White</p> <p>Black</p> <p>Junction Box</p> <p>Ground Wire</p>	<p>Once connections of wires are completed, carefully tuck wires and wire nuts into the electrical box making sure no bare wire (on the black and white) is visible at the wire nuts.</p>	<p><b>6</b></p> <p>Fixture backplane</p>	<p>After installation, use weatherproof caulk (not included) to seal the gap between the lamp and the wall, as well as the gap at the screw, and the bottom should not be filled to prevent moisture accumulation.</p> <p><b>The bottom should be left un-caulked to prevent moisture build-up.</b></p>

## 1-YEAR LIMITED WARRANTY\*

This light fixture is warranted against defects in material and quality for a 1-year period from the purchase date.

### Exclusions from Warranty:

- Damage caused by acts of nature, such as lightning damage or corrosion and discoloration of components.
- Damages resulting from abuse, improper installation, electric surges, or actions of third parties.
- Costs related to removing and resealing the lighting fixture.
- Damage caused by incorrect installation orientation.

If this product fails for any reason covered by this warranty, feel free to contact us.

# QUICK GUIDE

## Mounting Height: 6–10 ft

Install the fixture vertically on a wall, 6 ft to 10 ft above the ground, to avoid affecting the sensor's detection range.

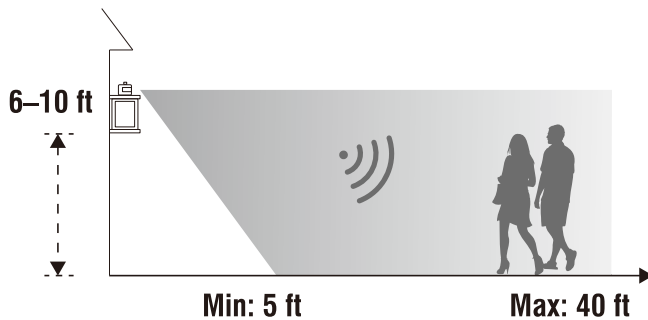

## Motion Detection

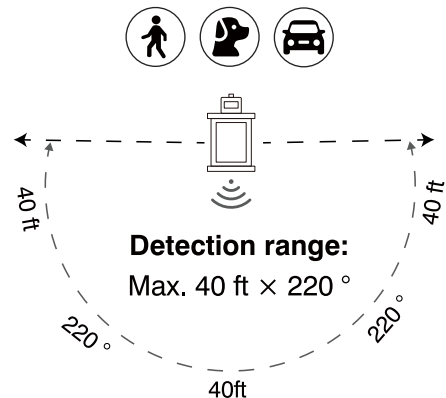

**Important**

After the lamps are installed,

**please adjust this knob from TEST to AUTO TIME**

(As shown in Fig.AA→Fig.BB), otherwise the lamps will not automatically turn off during the day, and other functions cannot be realized.

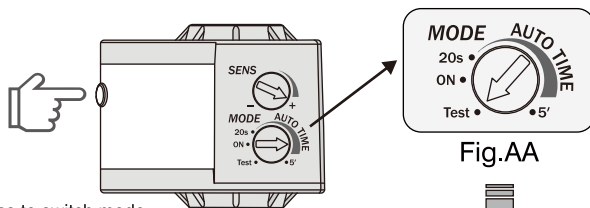

Short press to switch mode  
Long press to adjust brightness

Fig.AA

### TEST MODE:

When the fixture is powered on, it will illuminate for 15 seconds regardless of day or night, continuously testing the functionality of the fixture and bulb. It will then switch to the motion sensor test mode, where the fixture's sensor will briefly light up in response to motion to assist in the installation test. (The test mode is only for installation testing and is not a normal working mode.)(Fig.AA)

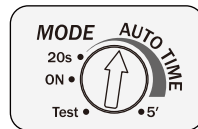

Fig.BB

### AUTO TIME:

After completing the initialization test, turn the MODE knob from "Test" to the "AUTO TIME" range (20s-5'). You can adjust how long the light stays on after motion is detected—from 20 seconds to 5 minutes.

**Only when the knob is set within the "AUTO TIME" range can you use the sensor button to switch between the three modes: DIM, ECO, and D2D.(Fig.CC)**

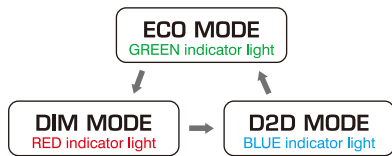

Fig.CC

## GFCI Outlet Usage Guide

1. After correct installation and powering on, when the "RESET" button is pressed, the green indicator light should illuminate, and the light fixture and appliances connected to the GFCI will start working.
2. When the "TEST" button is pressed, the "TEST" button will pop out, the green indicator light will go off, and the light fixture and appliances connected to the GFCI will stop working.
3. If the light fixture still does not work after being correctly installed and powered on, please check if the GFCI "RESET" button has been pressed; at this point, the green indicator light should be on.

### Specification

Hard-wired 125VAC 60Hz MAX:1800W  
12 AWG wire recommended.

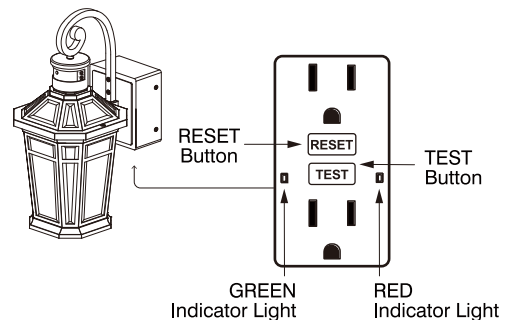

**!** It is prohibited to install GFCI receptacles on circuits that supply power to life support equipment!

**i** Please refer to the GFCI Outlet manual for more detailed function settings.

