

ASSEMBLY INSTRUCTION

WF310720AAA

WF310721AAA

WF310722AAA

WF310723AAA

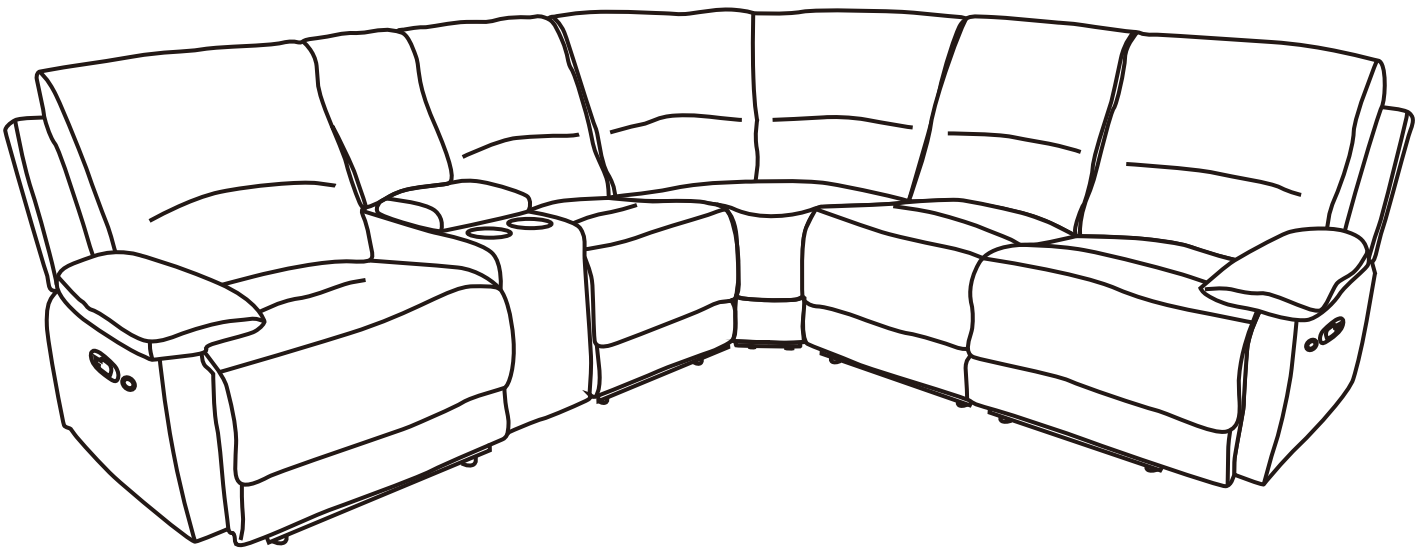

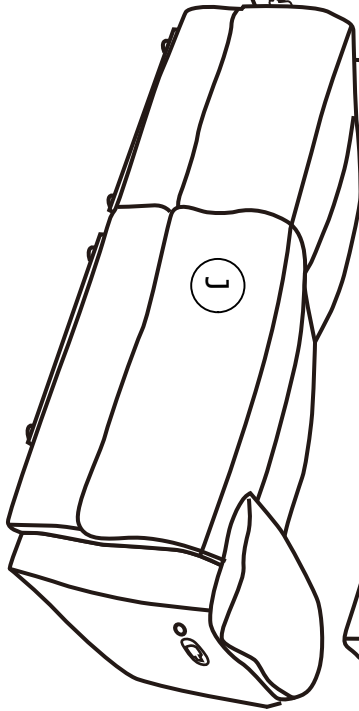
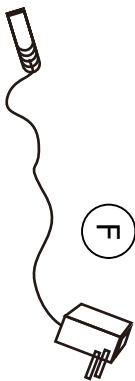
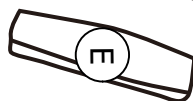
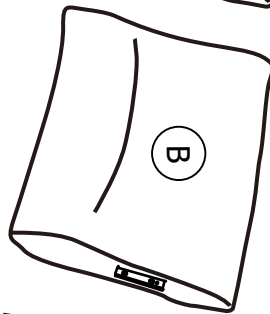
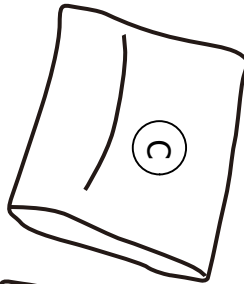
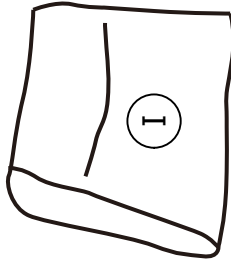
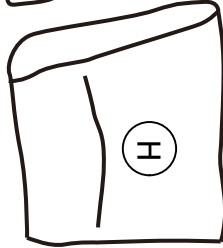
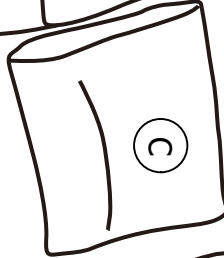
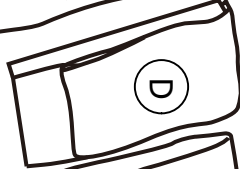
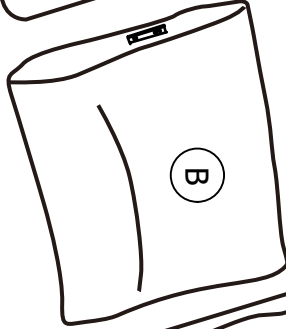
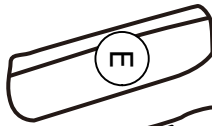
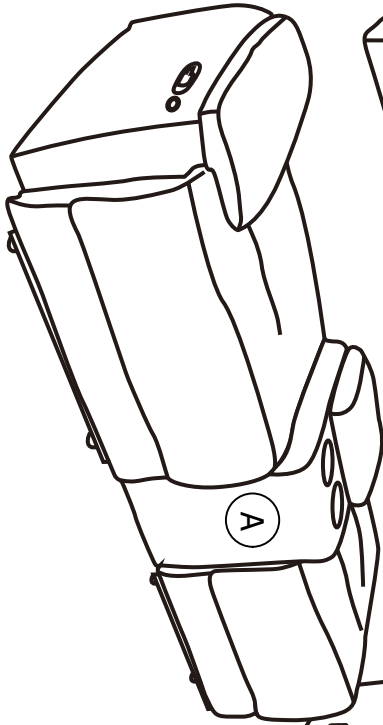

PARTS - WF310720AAA

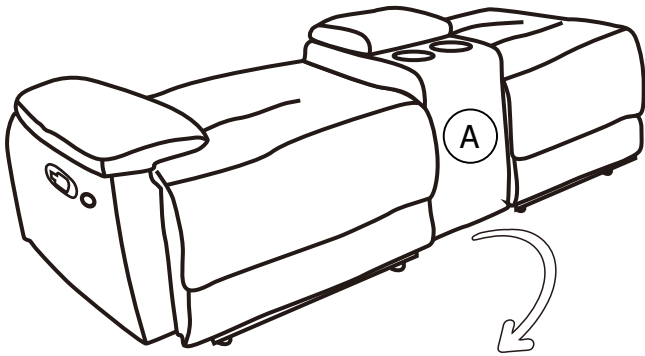

Loveseat & console x 1PC

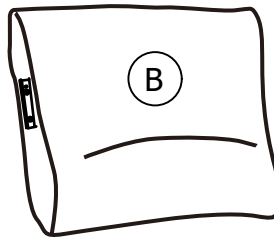

Side backrest x 1PC

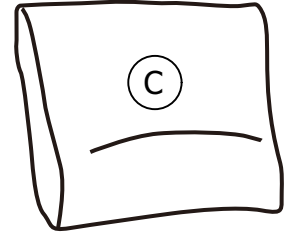

Backrest x 1PC

D is in the bottom of A,
please see **STEP1**

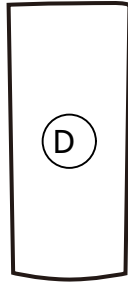

Console back x 1PC

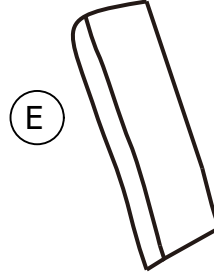

Ear x 1PC

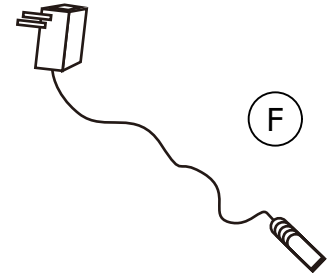

Power adapter x 1PC

WF310721AAA

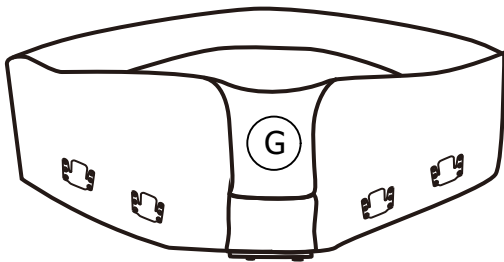

Corner seat x 1PC

WF310722AAA

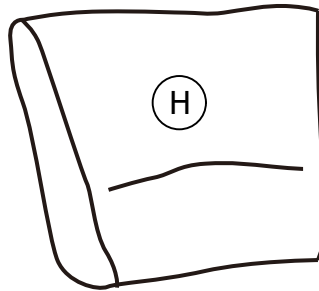

Left corner backrest x 1PC

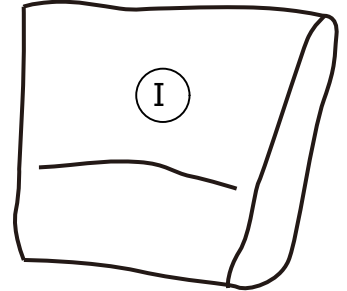

Right corner backrest x 1PC

PARTS - WF310723AAA

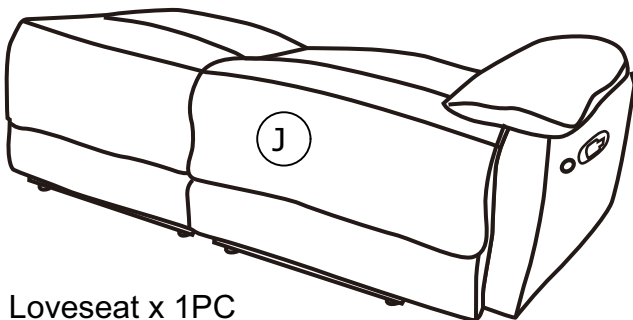

Loveseat x 1PC

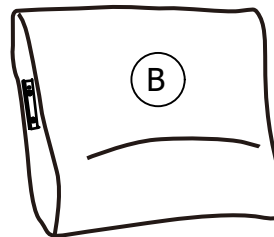

Side backrest x 1PC

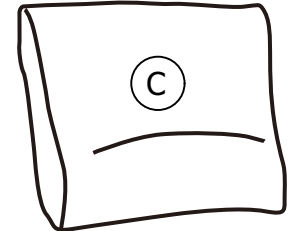

Backrest x 1PC

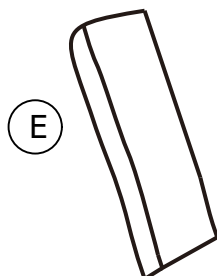

Ear x 1PC

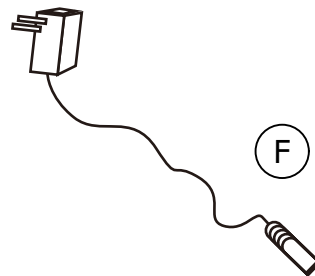

Power adapter x 1PC

STEP 1: Take D out of the bottom of A, as shown.

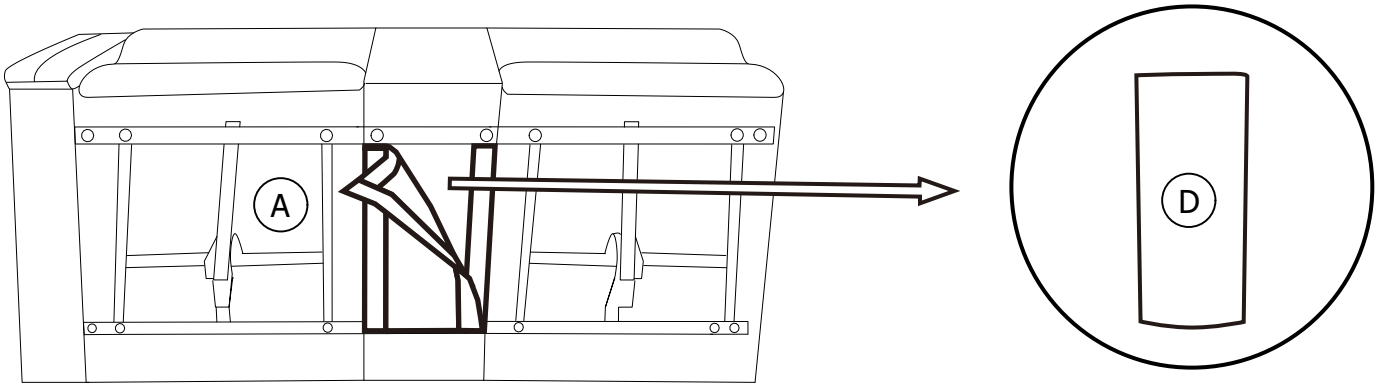

STEP 2: Insert B, C, D to A, as shown.

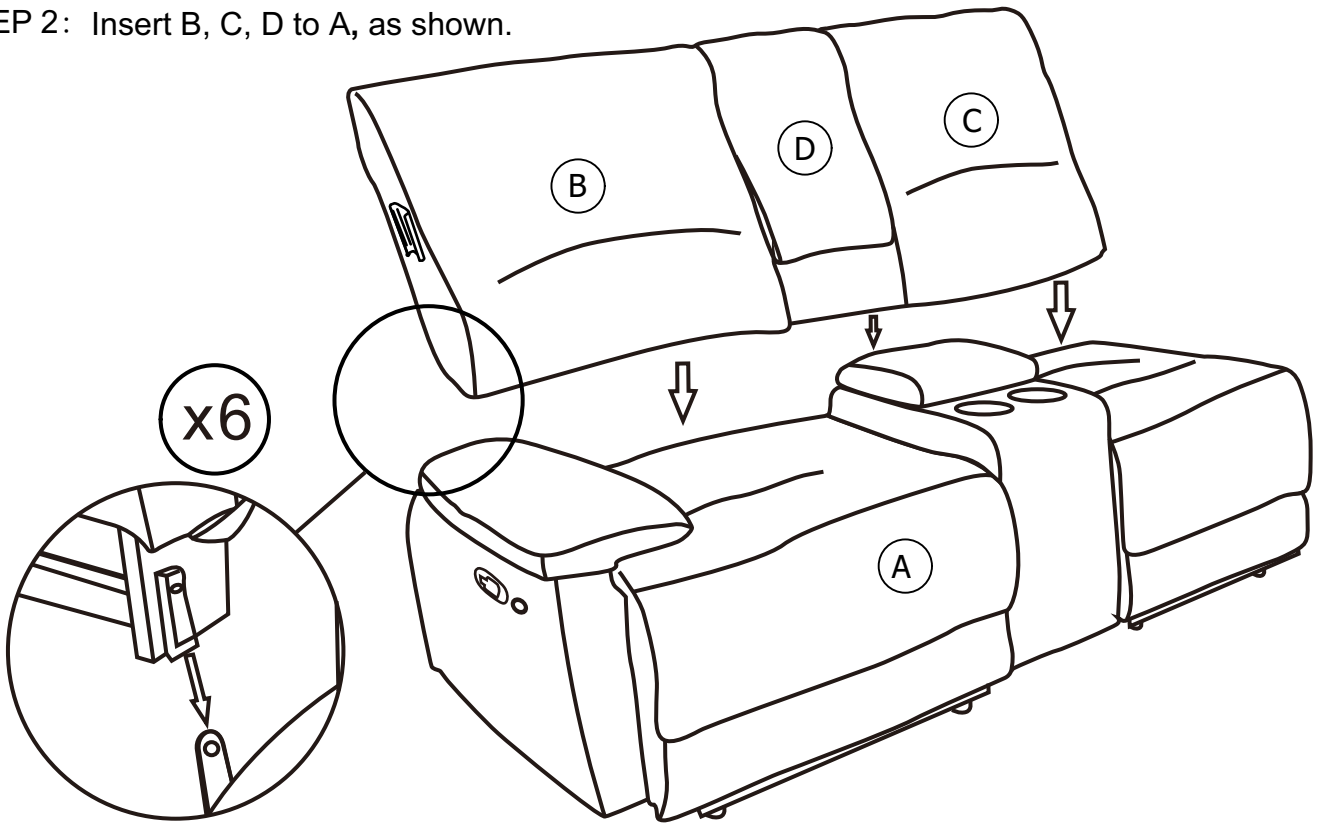

STEP 3: Insert E to B, as shown.

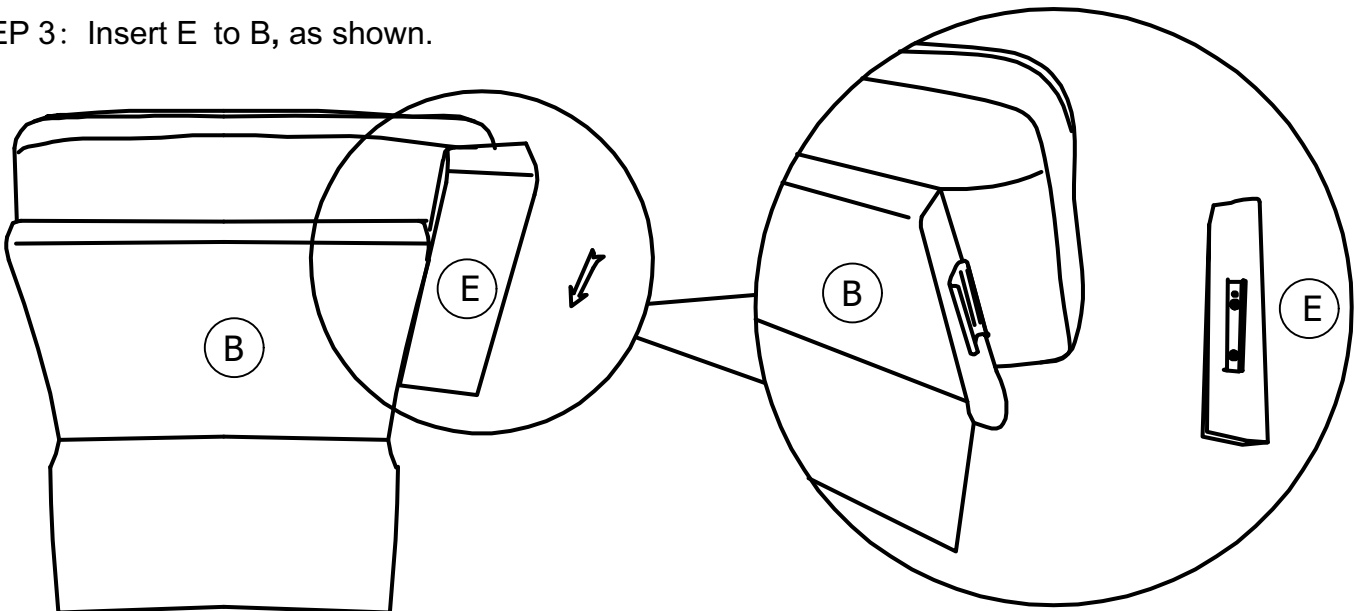

STEP 4: Insert B, C to J, as shown.

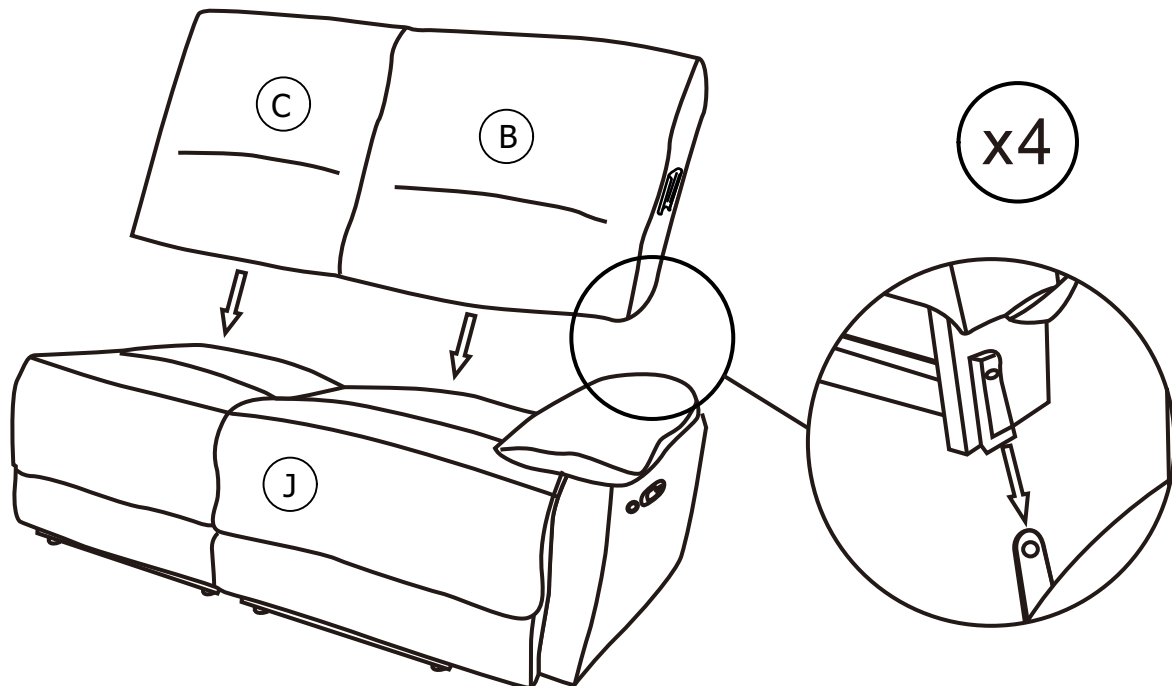

STEP 5: Insert E to B, as shown.

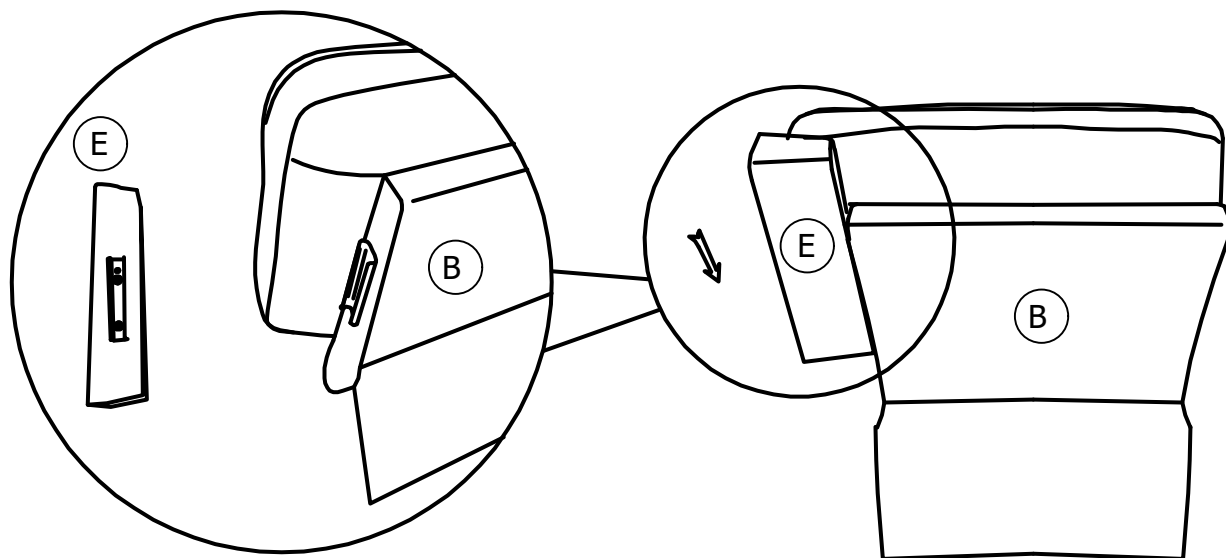

STEP 6: Insert H, I to G, as shown.

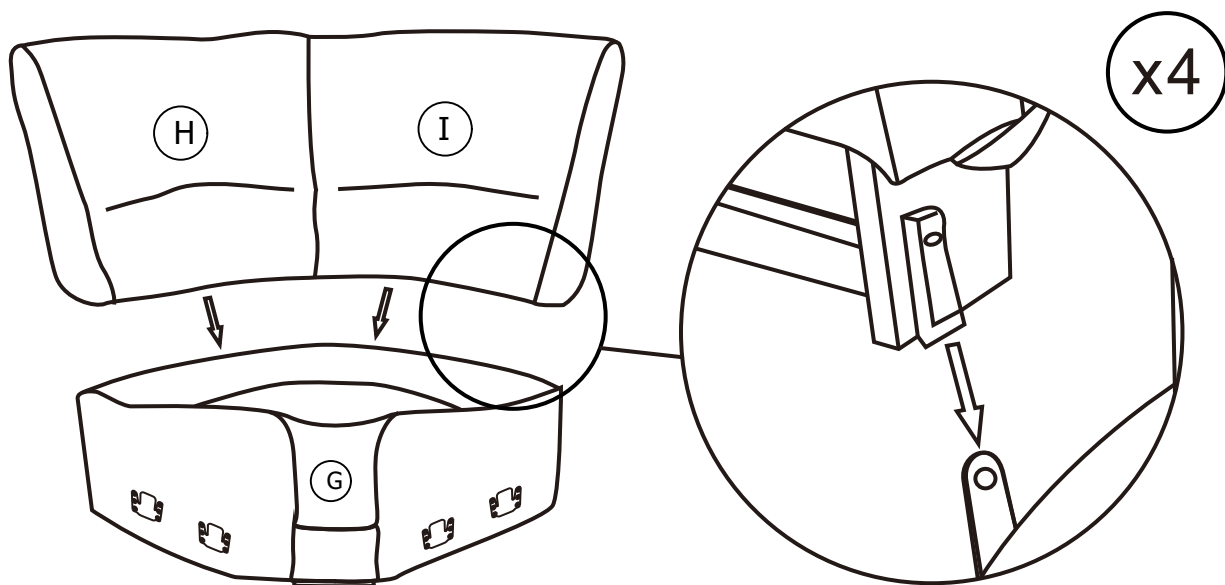

STEP 7: Insert A & J to G, as shown.

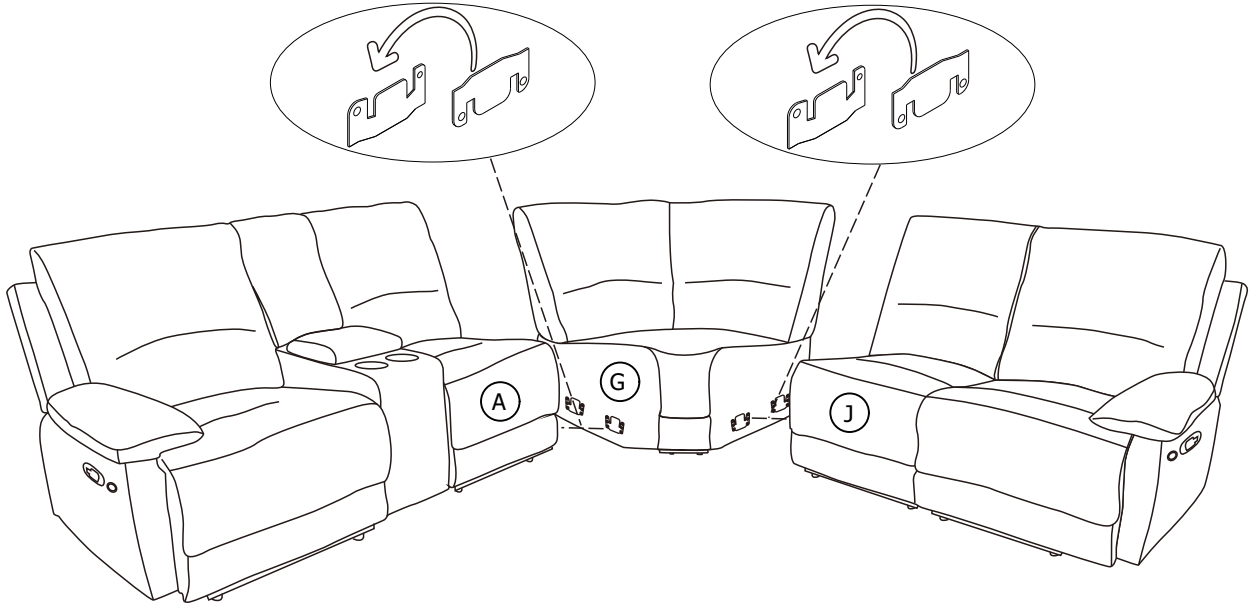

STEP 8: Insert F to Sofa, as shown. The switch controls the light under the seat; and the USB charging port is inside the console.

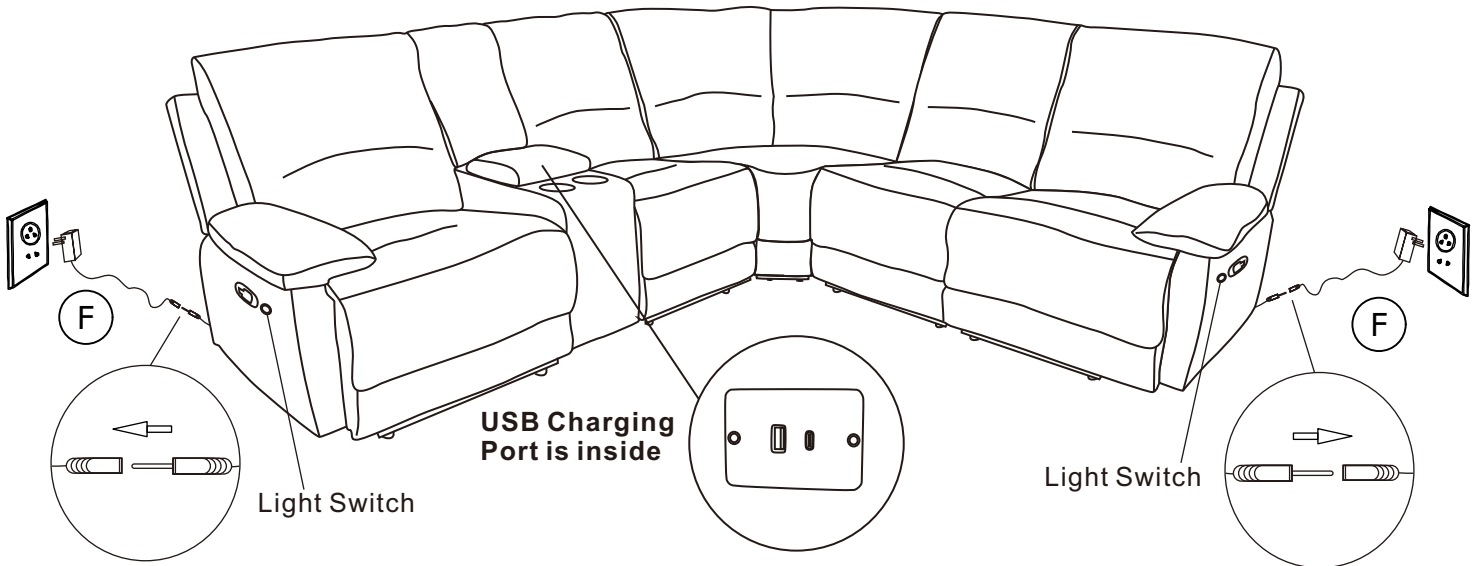

COMPLETED

