

■ Accent Chair

ASSEMBLY INSTRUCTION

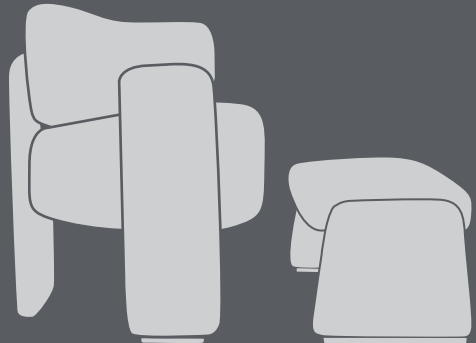

SKU:808

Dear customer, Thank you very much for buying our items. Please read the assembly instruction carefully before assembly.

Notices:

- Verify that all parts are present and in good condition before assembly.
- Put the chair on a clean flat surface.
- Please tighten the screws to about 80% for the first step; Then, sit with caution on the chair to adjust the balance; Finally, tighten all the screws to 100%.
- If you find that is unlevel after assembly, you can use adjustable pegs to keep four legs level.

Contact us

If there are installation problems, damage, missing parts, or any questions and concerns, please contact the shop where you bought it so we can make things right.

If the product is damaged, please send the following information:

- Photos that show the reason for your claim/damage.
- Photos of the packaging (inside and outside).

Thank you very much for your support!

Package Contents

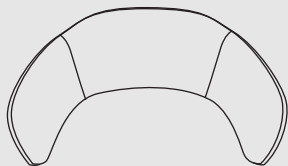

Back

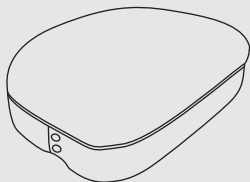

Cushion (B)



Cushion (A)

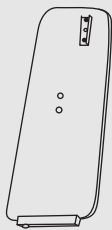

Left Armrest

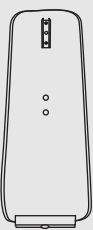

Center Armrest

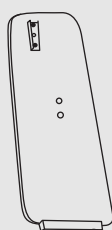

Right Armrest

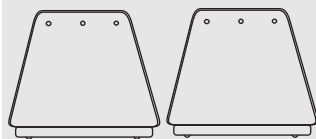

Legs

A × 12



Washer

B × 12



Spring Washer

C × 1

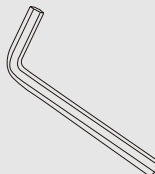

Spanner

D × 6

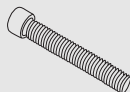

M8x50mm
Screws

E × 6

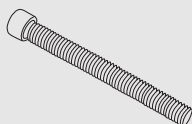

M8x70mm
Screws

Step by Step Guide

1

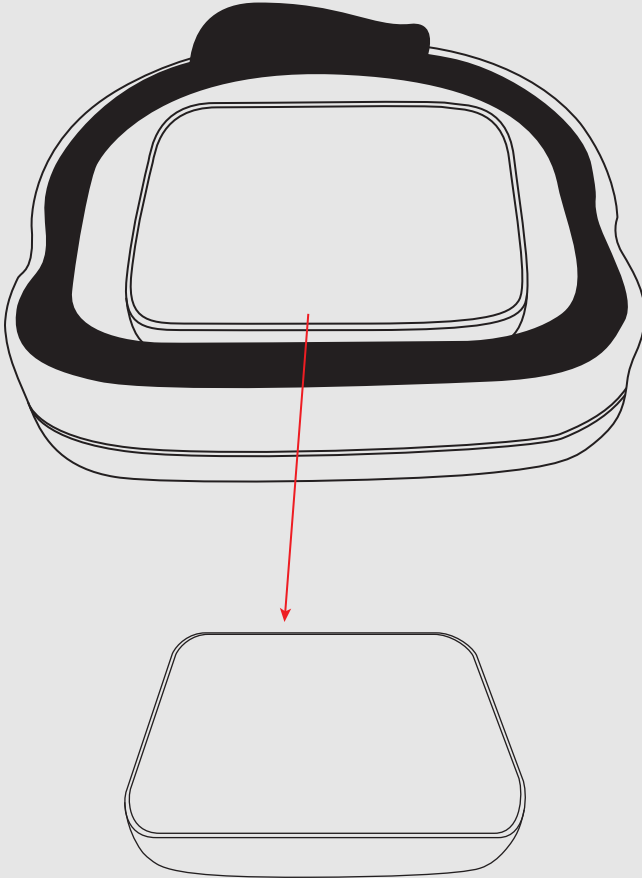

Flip the cushion(B) onto its back, zipper open the non-woven fabric and take out the cushion(A).

Step by Step Guide

2

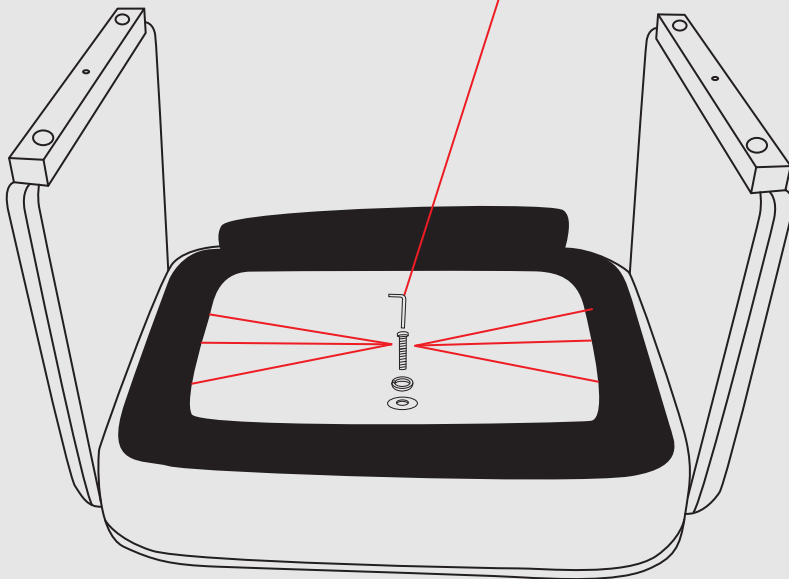
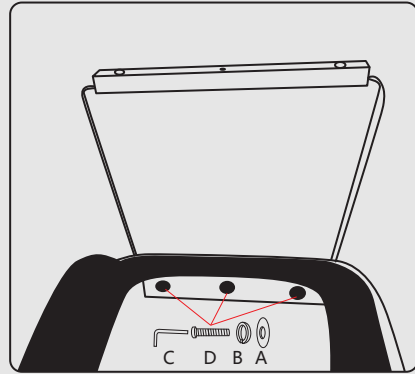
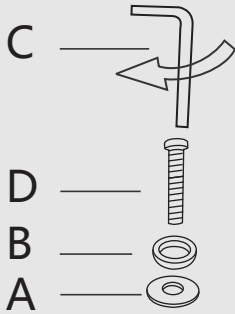

Align the two legs with the screw holes on both sides of the cushion and tighten them using the screws (D) and washers (A, B).

You'll have a small stool.

Step by Step Guide

3

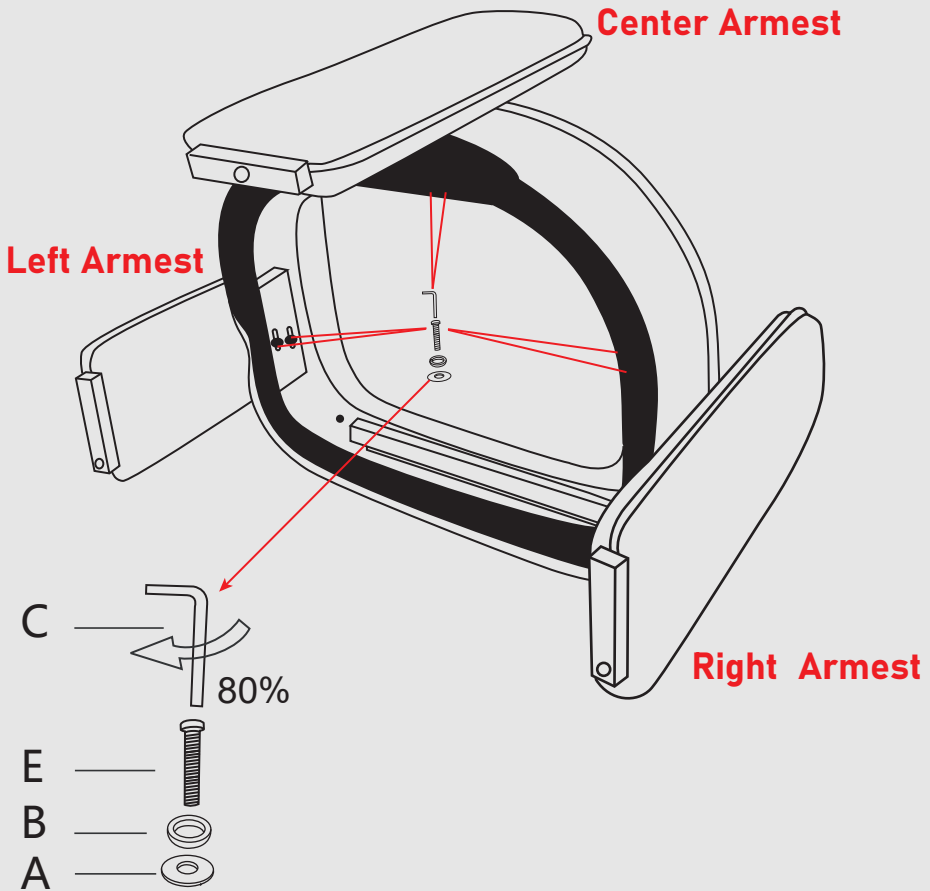

Install three armrests on the seat cushion (B), distinguish the left and right armrests. Align the seat cushion into the holes of the armrest by using the screw (E) with washers (A, B) and tighten them. Note: Screws are tightened to 60-80% at this point.

Step by Step Guide

4

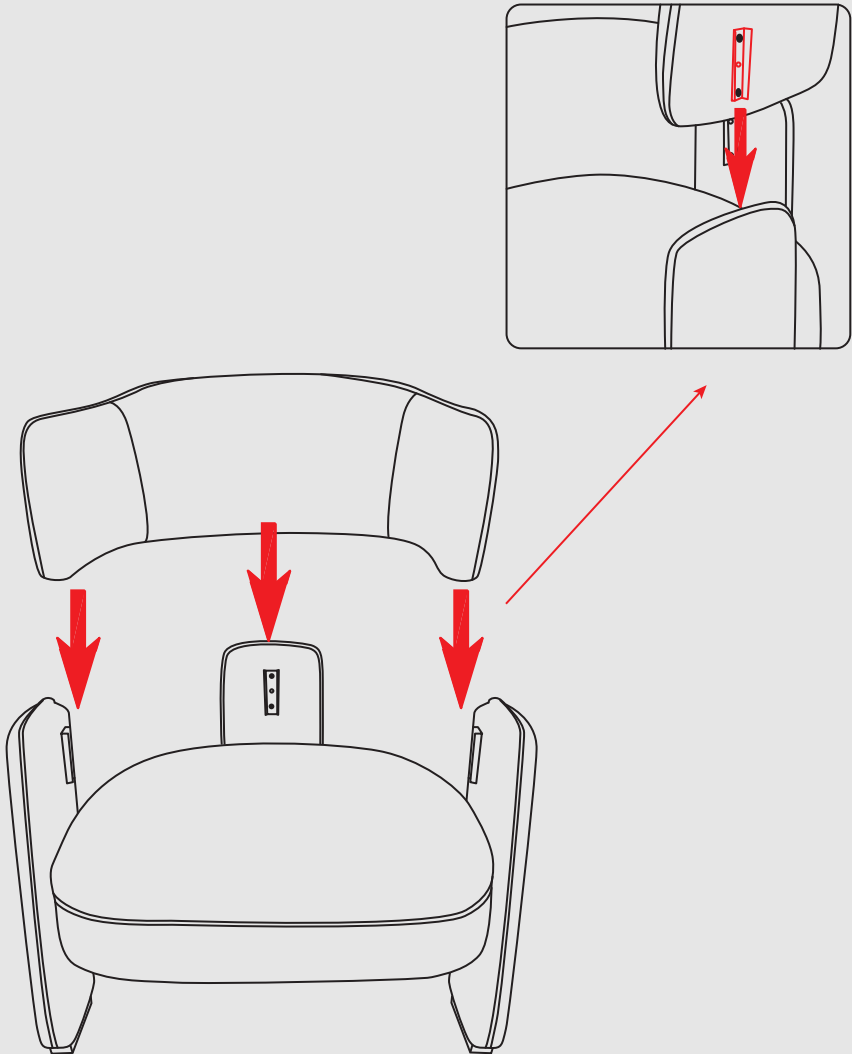

Take out the backrest and align the three inserts of the backrest with the sockets on the three armrests.

Step by Step Guide

5

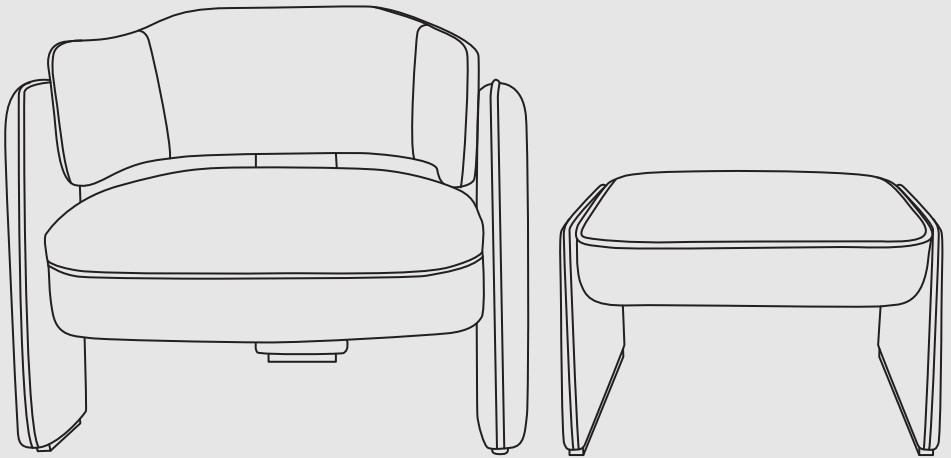

Put chair in the upright position and sit on it to press downwards on the seat pad. Ensuring that all 3 armrest touch the ground and chair is leveled. After confirming the chair is stable, tighten all screws(E) to 100%.

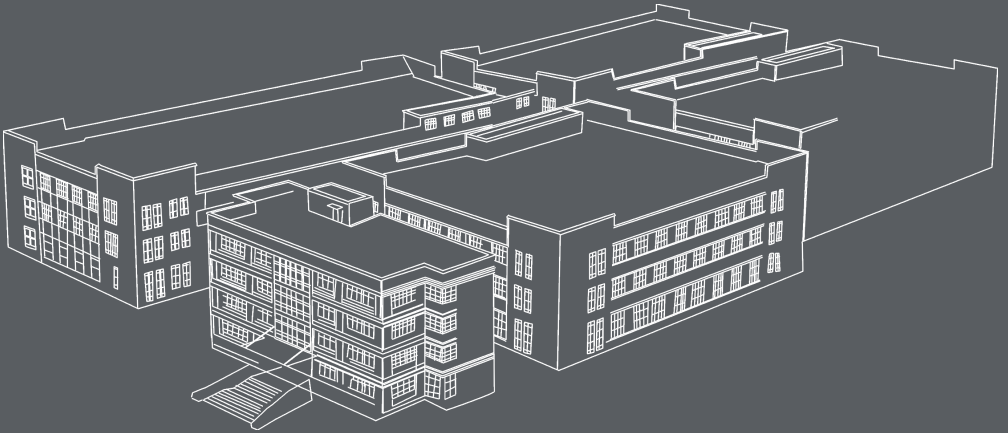

About us

We are a professional manufactory for making and selling dining chairs. In the past 15 years, we have exported millions of chairs to Europe and USA.

We focus on providing you with high-quality products that meet international standards. To ensure timely shipping, we have built large warehouses in California, New York, and Georgia.

Contact us

The fastest way to get more information about the deals!

Email: support@pekkohome.com