

MURALLA PENDANT



MURALLA PENDANT LIGHTS



## MURALLA PENDANT

---

5 MURALLA PRODUCT DETAILS

## ACCESSORIES

---

10 ACCESSORIES  
12 CANOPIES  
14 CHOOSE YOUR PENDANT HEIGHT  
15 CORD SET OPTIONS

## LAMPING OPTIONS

---

18 MURALLA BULBS  
20 VOLTAGE MAP  
22 INSIDE THE BOX  
24 INSTALLATION GUIDE

## MULTI-PENDANTS

---

28 MULTIPLE JUNCTION BOXES  
28 TRACK LIGHTING  
29 MULTI-PENDANT CANOPY  
31 MULTI-PENDANT INSPIRATION  
36 THE LINEAR COLLECTION  
37 THE CIRCULAR COLLECTION

## CONNECT

---

40 CONTACT INFORMATION

# MURALLA

PENDANT



PICTURED ABOVE IN CRYSTAL

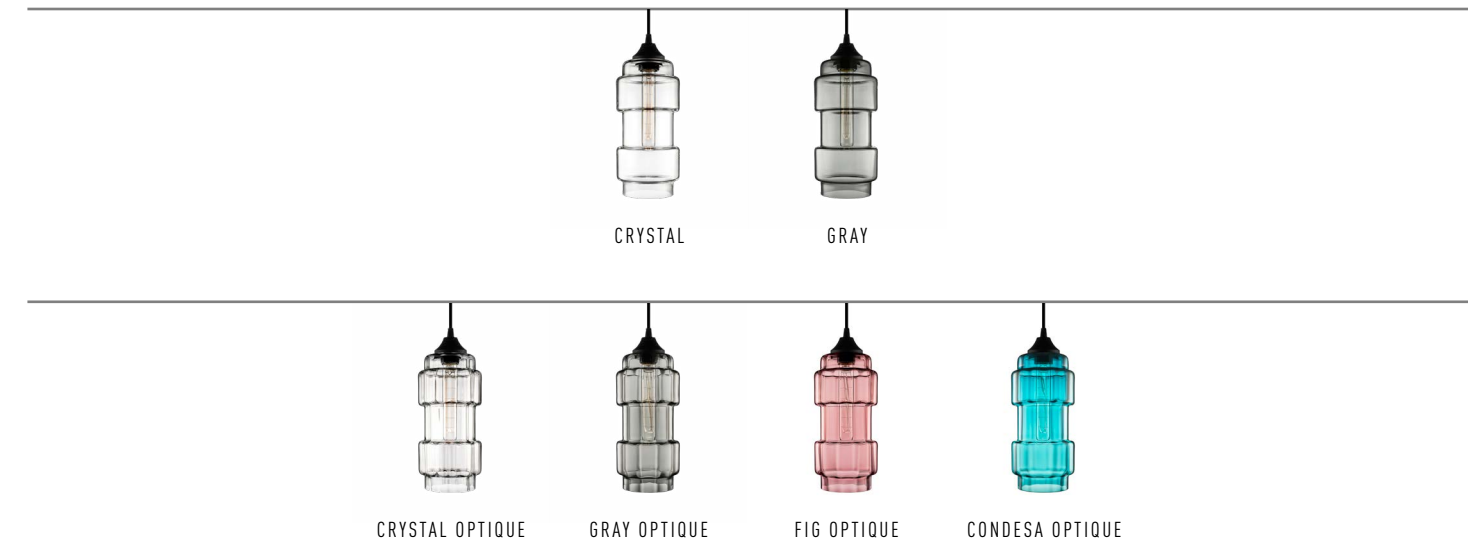

## PRODUCT DETAILS

Inspired by ancient castle walls, the defined edges and slender build of the Muralla pendant enhance any setting.

## SPECIFICATIONS

Hand-blown glass

Includes: Muralla glass shade, 4' black cord and 5" black ceiling canopy. See [Tear Sheet](#) for more information.

## DIMENSIONS

10.5" H x 5" W

## PRODUCT PAGE

<http://shop.nichemodern.com/product/muralla-modern-pendant-light.html>

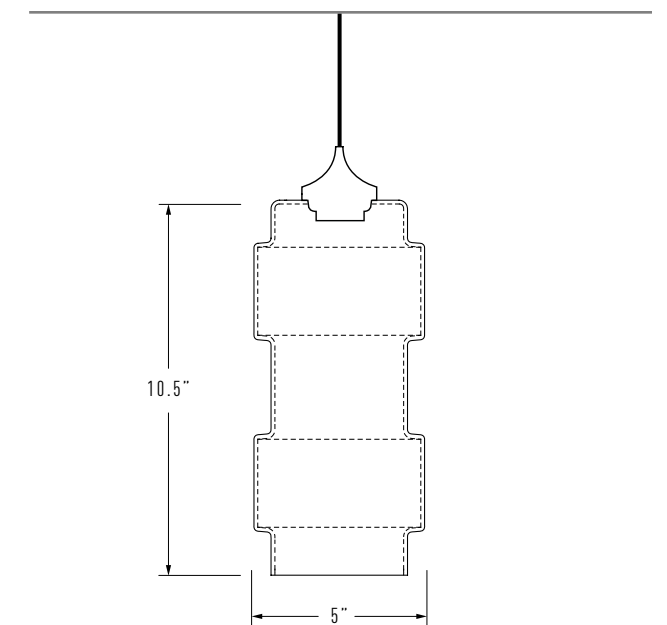





## THE PERFECT FIT.

At Niche, we know how important good lighting is. That's why our glass artisans dedicate time to hand-crafting luxury products from the finest materials, including our slender pendant, the Muralla. Available in an array of new colorways, this pendant will be the perfect fit for your next project. We are inspired to continue creating and lovingly crafting pieces like these for you.



**ACCESSORIES**  
CUSTOMIZE YOUR PENDANT

# CANOPIES

IT'S ALL IN THE DETAILS



BLACK



WHITE



POLISHED NICKEL



BRUSHED NICKEL

## CHOOSE A CANOPY FINISH

Choose from one of our 4 unique finishes to blend in seamlessly with your space! All Niche canopy kits include a 5" domed ceiling canopy, mounting plate & screws. The canopy will cover any standard sized opening and allows for installation directly into an electrical box.

# CORD SETS

HOW LOW CAN YOU GO?

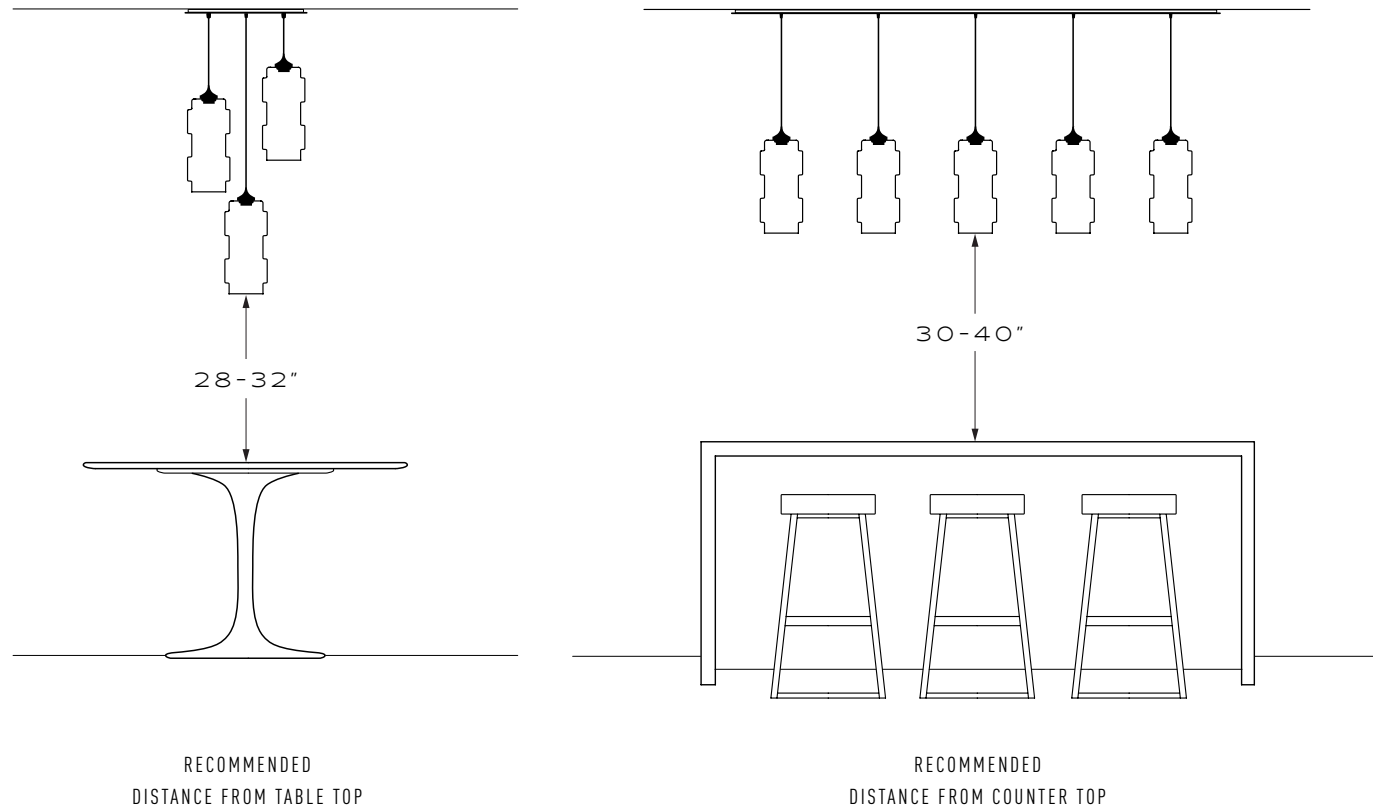

The standard 4' length that comes supplied with your Niche pendant should work for most installations. Your electrician can easily adjust the height up or down before installing so you can get it just right.

"A little higher. Now a little lower. Ok, perfect!"

## AT THE END OF YOUR ROPE?

All Niche cord sets can be cut on site to the desired length. To find out how much cord length you need just take the measurement from the floor to the ceiling and then subtract that from the distance from the floor to the bottom of the glass. It's easy and we're always here to help make sure you have exactly what you need.



## STANDARD 4' BLACK CORD SET

Our 4' black cord set comes standard with your order, but you can also select from longer lengths or choose the sleek and chic silver cord.

Cord sets are available in both 120 and 240-volts. Take a look at the [map page](#) to find out what type of voltage you need for your installation.

4'

12'

24'

## BLACK CORD SET OPTIONS



## SILVER CORD SET OPTIONS





LAMPING OPTIONS

MURALLA PENDANT

# LAMPING OPTIONS

## MURALLA PENDANT



INCANDESCENT  
BEACON BULB

The warm amber glow of the vintage style filaments in the Beacon bulb will provide a nostalgic feel to any environment. This multi-voltage bulb is 30 watts at 120v and 60 watts at 240v. We recommend that you install on a dimmer so that you can adjust the mood and feel.



LED  
BEACON BULB

Available in 120v and 240v options, the LED Beacon Bulb features a single, uninterrupted filament rather than a segmented one. This clear, sleek bulb is also dimmable and transitions smoothly between varying levels of brightness.



PICTURED ABOVE WITH  
INCANDESCENT BEACON BULB



- 100-120V
- 220-240V

The Muralla pendant can accommodate both 120 and 240-volt settings. 120v bulbs are included. Please call or email us for 240v bulb options.

**WHERE IN THE WORLD ARE YOU?**  
USE THIS MAP TO FIND YOUR VOLTAGE

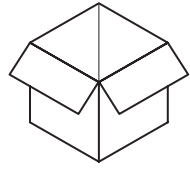

# INSIDE THE BOX

HERE'S WHAT'S INCLUDED!

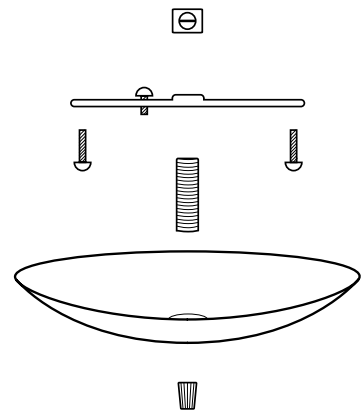

5" CEILING CANOPY

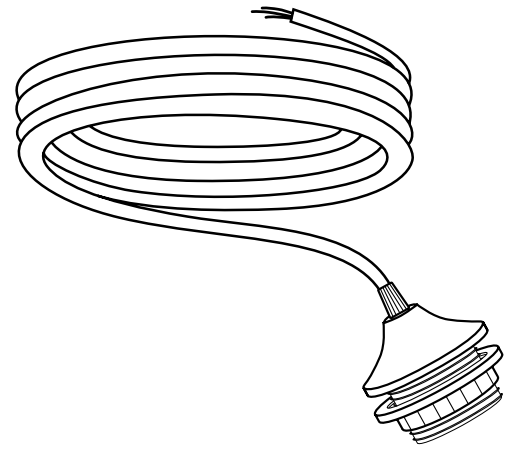

CORD SET

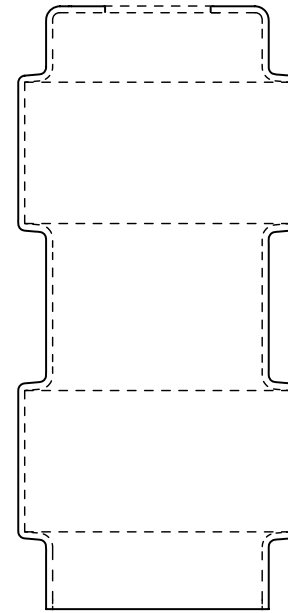

GLASS SHADE

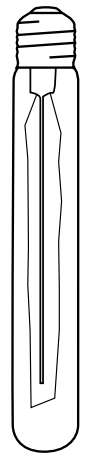

BULB



# INSTALLATION

IN A NUTSHELL...

## 1 SET DROP LENGTH

Measure twice, cut once! Make sure your pendant hangs at the right height by setting your drop length ahead of time.

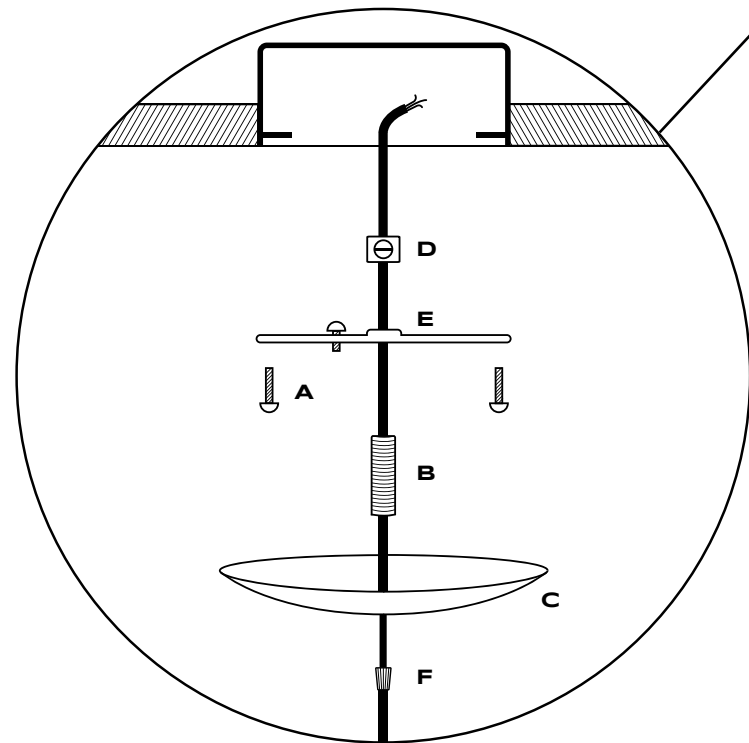

## 2 WIRE IT UP!

Your pendant includes everything you need to install directly into an electrical junction box. Thread the wire-end of your cord through the included parts of the canopy kit, as pictured. Connect the light fixture wires to the wires in the junction box, followed by attaching (E) the crossbar & (C) the canopy.

Your electrician will be able to help you with these steps!

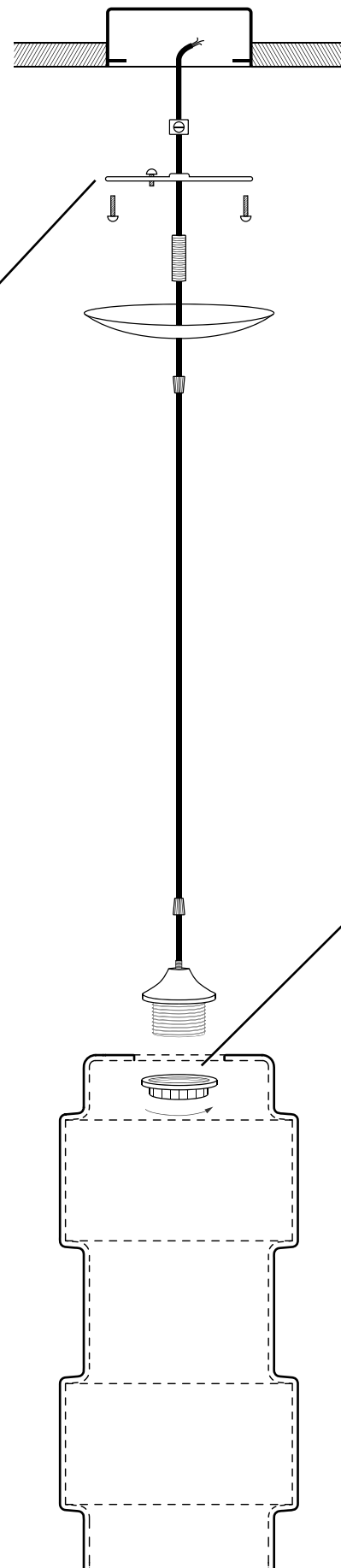

## 3 THE FINAL MOMENT

When attaching the glass shade onto the cord, remove (J) the shade ring from (I) the threaded socket. When doing so, it is important to grip (H) the socket cover on the top, both the shade ring and the socket cover can unscrew. Hold the socket cover in place when re-attaching the shade ring to hang glass and when removing glass to clean.

Finally, insert your bulb & flip the switch!

### CAUTION

Be sure the power is turned off by either removing the fuse or shutting off the circuit breaker. Installing your Niche pendant is pretty straightforward, but we always suggest that you work with a certified electrician to ensure proper installation. An electrician can also install your lights on a dimmer switch if using dimmable bulbs. This is highly recommended.

## STANDARD CANOPY KIT INCLUDES

- A MOUNTING SCREWS
- B NIPPLE PIPE
- C CANOPY
- D WIRE STRAIN RELIEF
- E CROSSBAR
- F CANOPY STRAIN RELIEF
- G GLASS STRAIN RELIEF
- H SOCKET COVER
- I THREADED SOCKET
- J SHADE RING



**MULTI-PENDANT**

INSTALLATION IDEAS

# THE MORE THE MERRIER

## HOW TO HANG MULTIPLE PENDANTS

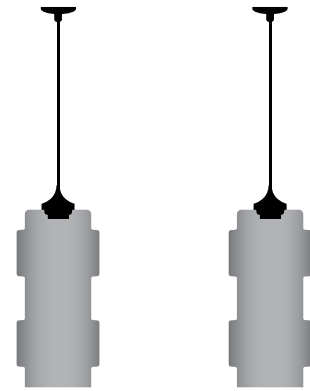

### MULTIPLE JUNCTION BOXES

All Niche pendant lights ship with an individual canopy included. This allows for installation directly into a standard junction box. Selecting multiple pendants, whether it's 2 or 3 above a kitchen island, can help visually define your space. Each will require a separate junction box but the 5" dome canopy provides a classic look that works with multiple pendants.

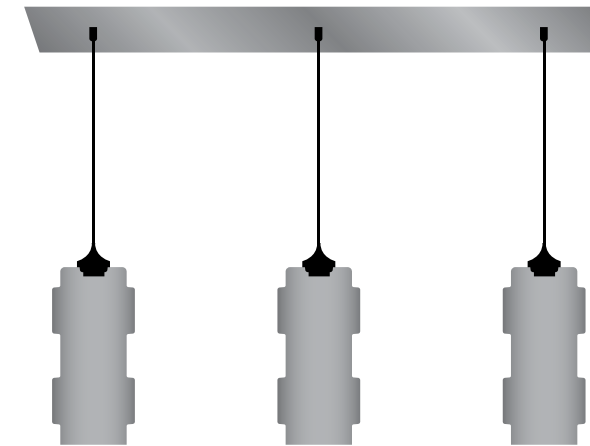

### MULTI-PENDANT CANOPY

Electricians aren't cheap, so if you're planning on hanging more than one pendant you may want to look at our Multi-Pendant Canopy options. This way your electrician only needs one electrical junction box to hang multiple pendants. Choose from a number of our Circular or Linear canopies to hang 2, 3, 4 or more pendants.

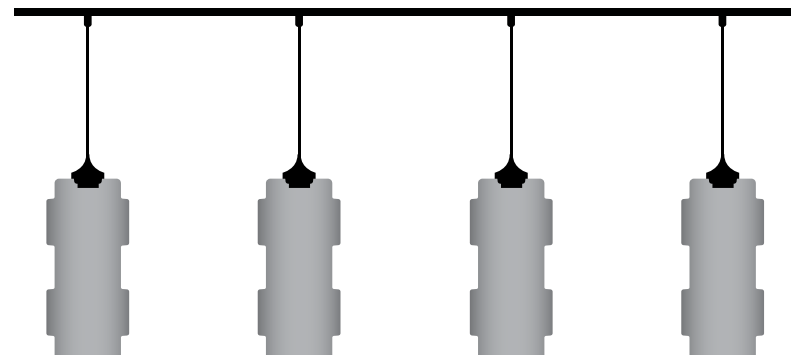

### TRACK LIGHTING

Track lighting allows you to hang multiple pendants with the freedom to move and position the lights anywhere along the track grooves. Ask your electrician about installation options. Niche pendants are compatible with Halo, Juno and Lightolier line voltage track systems. Niche can provide Halo compatible track connectors which your electrician can wire at the desired height.

### CUSTOM DESIGN SERVICES

Team Niche is a group of magical beings. We'll wave our magic wands and create something special, just for you. [Contact us](#) to get started on your custom installation today!

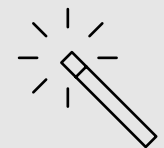

# INSPIRATIONAL SETTINGS



## MULTIPLE JUNCTION BOXES

There are endless possibilities when using multiple junction boxes to hang luxurious lighting over your side tables. Individual dome canopies provide a classic, uniform look when hanging multiple Muralla pendants and visually define your space.

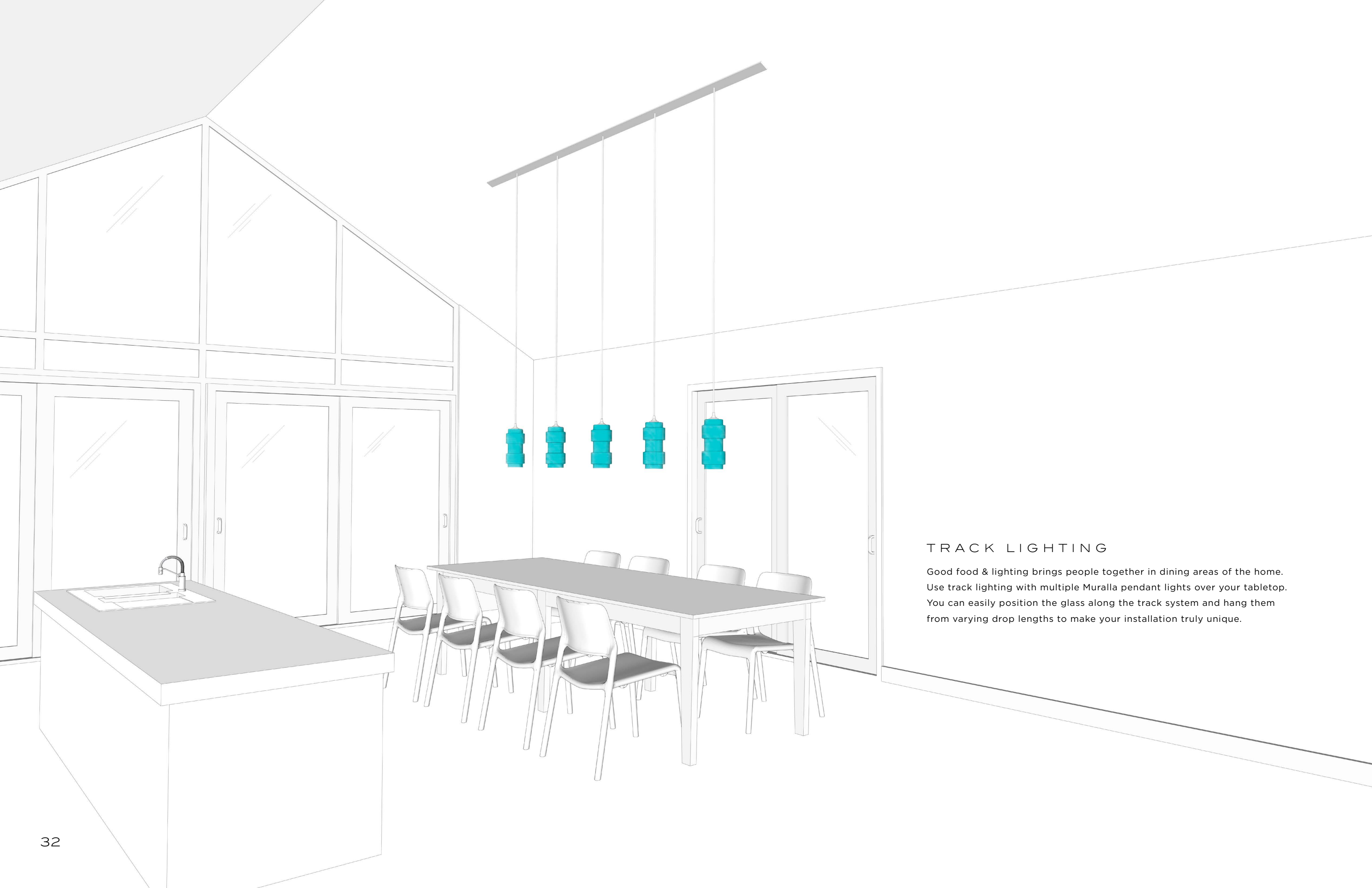

## TRACK LIGHTING

Good food & lighting brings people together in dining areas of the home. Use track lighting with multiple Muralla pendant lights over your tabletop. You can easily position the glass along the track system and hang them from varying drop lengths to make your installation truly unique.



## CIRCULAR CANOPY

Spending time with family and friends in a gathering space can be illuminated by the presence of stunning lighting. Create cascading clusters of Muralla pendants in various sizes and colorways from a Circular Modern Chandelier, which offers a simple solution to hang 3, 5, 7, or 9 pendant lights from a metal canopy with multiple finish options.

# CANOPY COLLECTIONS

## THE LINEAR COLLECTION

LINEAR 2  
8" x 32"

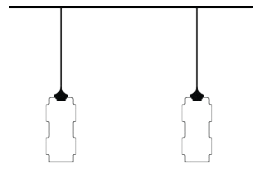

LINEAR 3  
8" x 48"

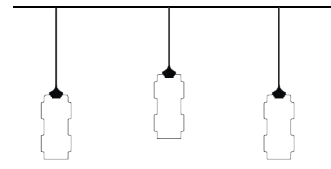

LINEAR 4  
8" x 64"

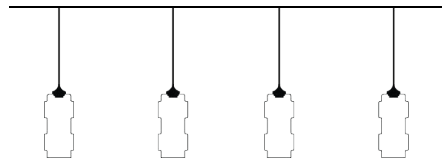

LINEAR 5  
8" x 80"

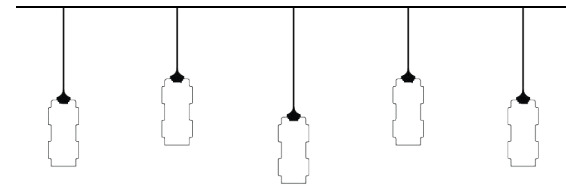

Visit our website for more information about the [Linear](#) Canopy Collection.

## THE CIRCULAR COLLECTION

CIRCULAR 3  
18" diameter

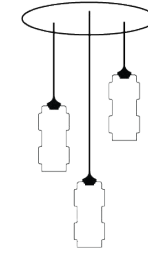

CIRCULAR 5  
18" diameter

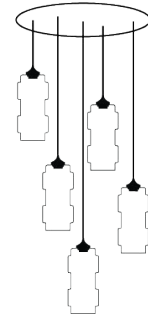

CIRCULAR 7  
23.5" diameter

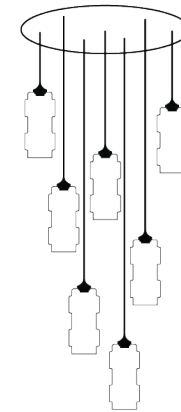

CIRCULAR 9  
23.5" diameter

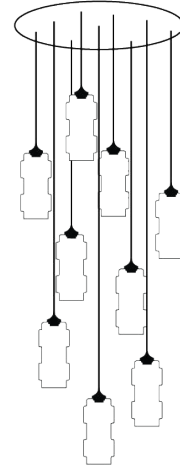

Visit our website for more information about the [Circular](#) Canopy Collection.



“SIMPLICITY, CARRIED TO AN  
EXTREME, BECOMES **ELEGANCE**.”

-JOHN FRANKLIN



Located along the Hudson River, Niche calls the city of Beacon home.

It's also where our products are handmade to order by our team of talented artisans. When you purchase from Niche you can be certain that it's designed in New York with love.



Connect with us online, or the old fashioned way:

P.O. Box 311  
Beacon, NY 12508  
T: 212.777.2101  
F: 212.777.2051





M A D E  
*not*  
M A N U F A C T U R E D