

Assembly & Instruction Manual

SKU:A222

Window Planter Box

Installation Guide

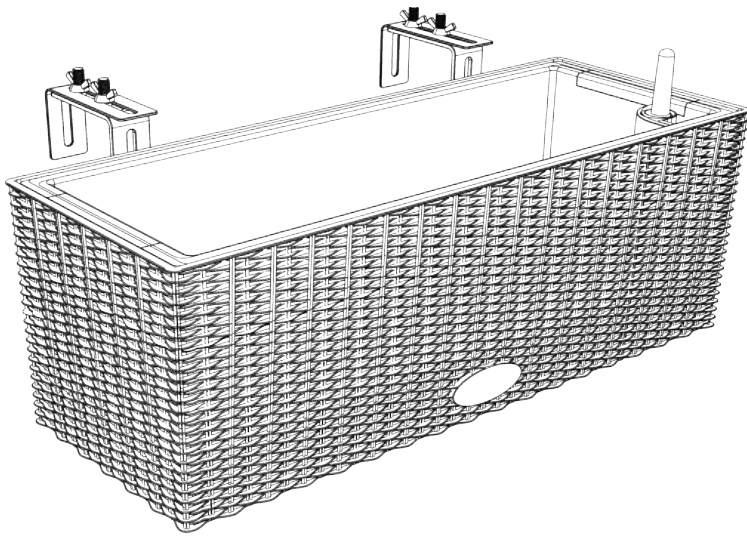

x4

Version: 20241015

Approximate assembly time: **8 Minutes**

People for assembly:



Parts list (unit)



..... A

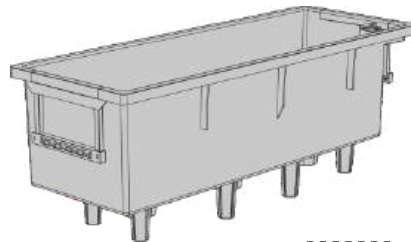

..... B



..... C

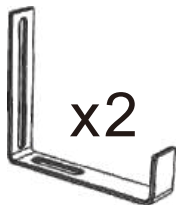

x2

..... D

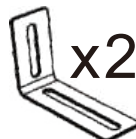

x2

..... E

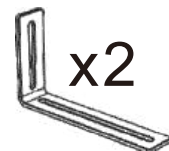

x2

..... F



x2

..... G



x12

..... H



x4

..... I



x4

..... J

Save this manual for future reference

Optimal Irrigation Guide

- The Raised Patio Garden Bed is equipped with a water basin and gauge to make it easier for you to grow beautiful, healthy plants that have all the nourishment they need. All you need to do is keep an eye on the floating top. If the floating top sinks to its minimum height, you should wait several days and then water the plants. The precise number of days you wait depends on the type of plant and growing environment.

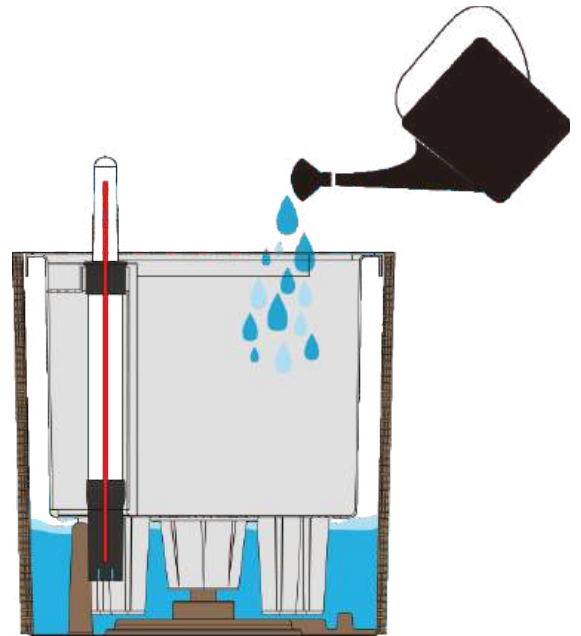

- It is recommended to occasionally pull out the drainage cap in order to drain excess water and keep the roots healthy.
- It is often a good idea to recycle drainage water from the Raised Patio Garden Bed by using it to water other plants, as it is rich in natural salts and minerals. This helps to conserve water and contribute to a more environmentally-friendly garden.

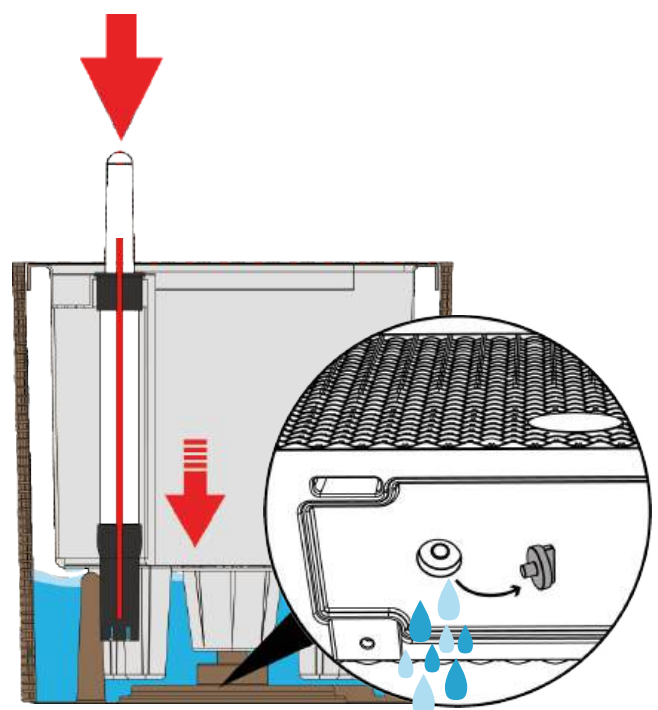
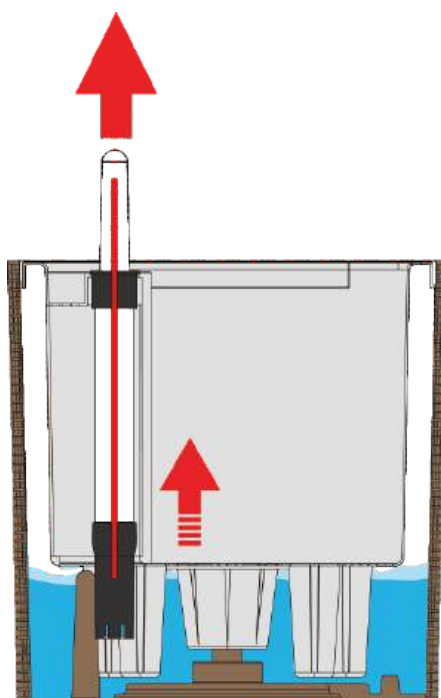

Optimal Irrigation Guide

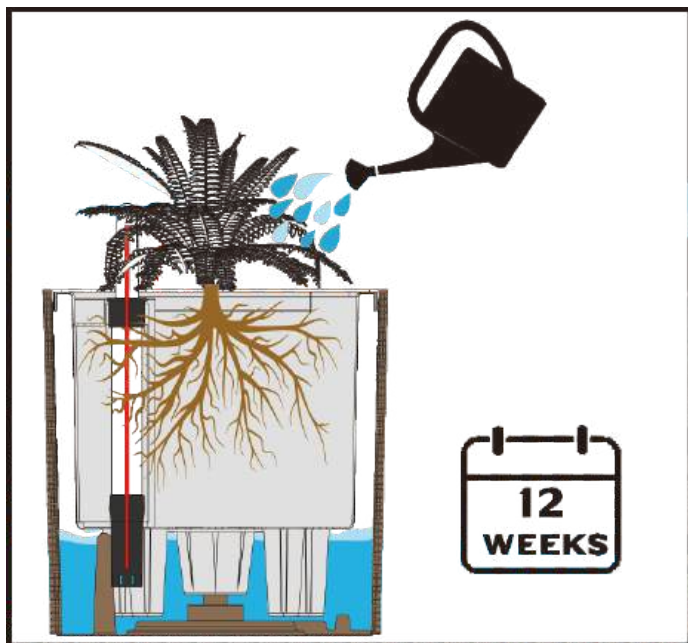

Step 1

Water the plant on top of the soil, not through the reservoir supply shaft for at least 3 months. This is the growing in phase.

At the bottom of this page is a volume guide. Do not over-water your plant. Dryness encourages the roots to grow into the system.

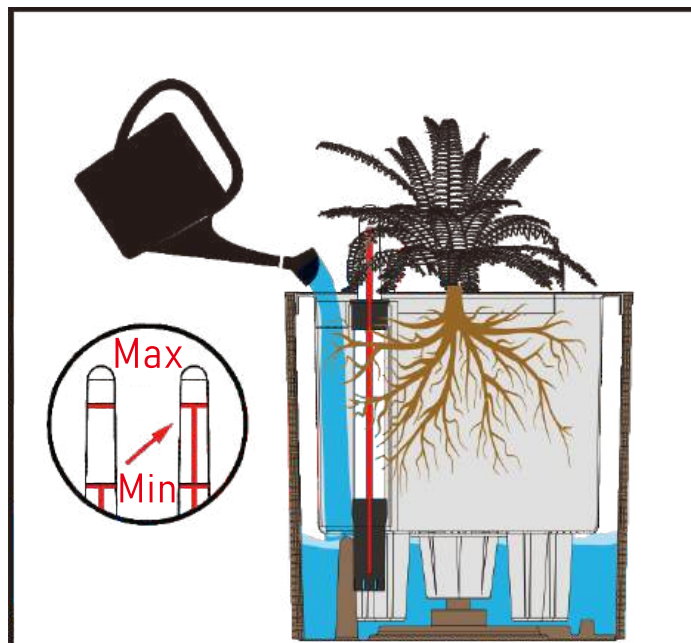

Step 2

Once you have completed the growing in phase, fill the reservoir. If you have a less thirsty plant, only fill it half way. If you're unsure, just fill it two thirds up.

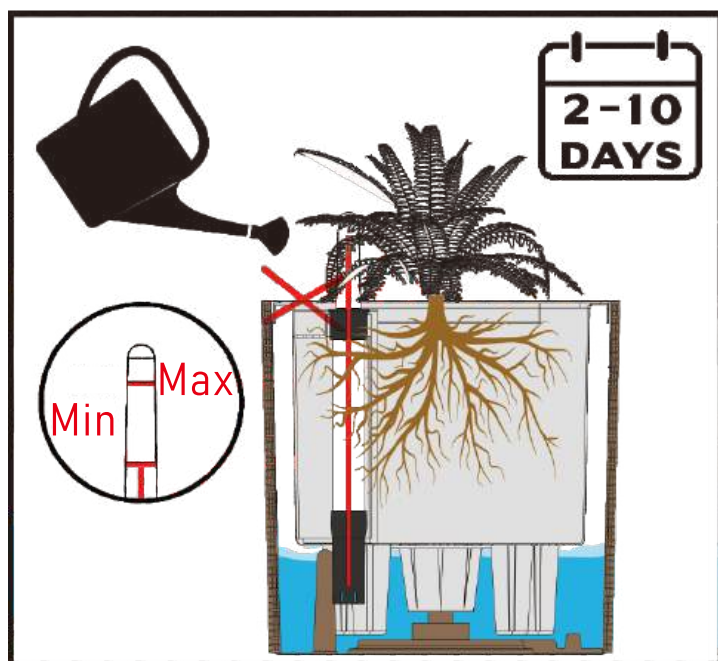

Step 3

Wait until the indicator reaches minimum, then leave for a further 2-10 days. Warmer and drier conditions mean a shorter interval. A large planter, like a classico 43cm, will need a longer interval.

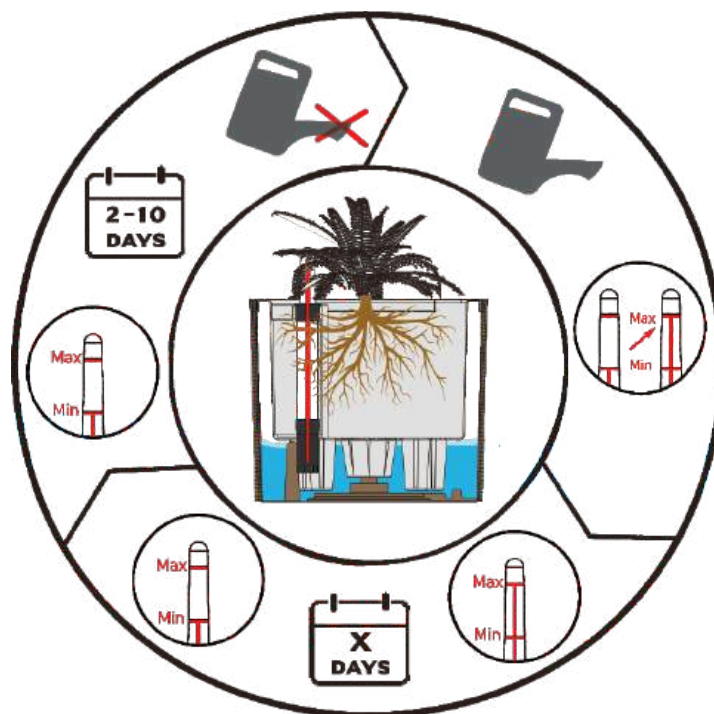

Step 4

Re-fill the reservoir and repeat step 3, it's that easy!

Assembly

Step1

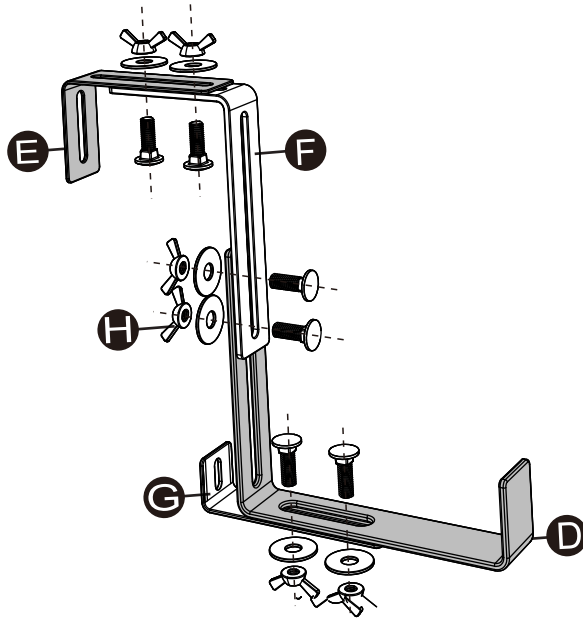

Step2

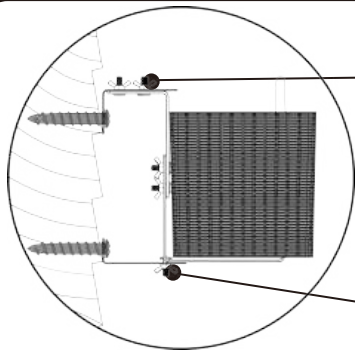
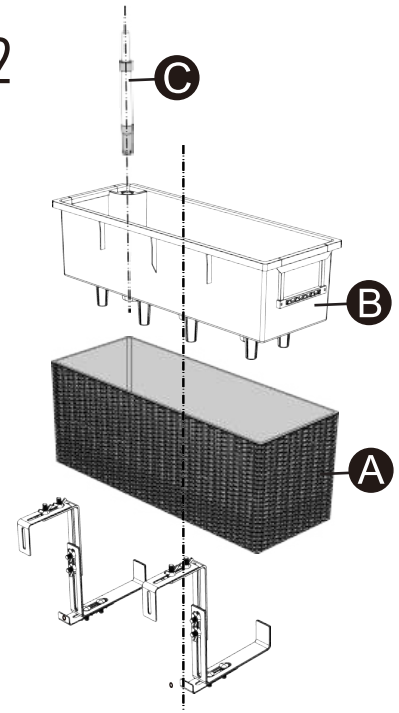

This illustration shows the shorter brace being used on top. You can use either a short or long brace on top, depending on which one best fits your siding. Insert the bolt from underneath, then add the washer and wing nut. Tighten after making any necessary adjustments.

Install the wing nut and washer underneath the bracket.

In the illustration above, the window box is attached to wood siding beneath a windowsill. Check with your local hardware store to find the mounting hardware that's right for your house.

The example below shows one way to attach the window box to a railing. The brace can be adjusted to fit different types of railings.

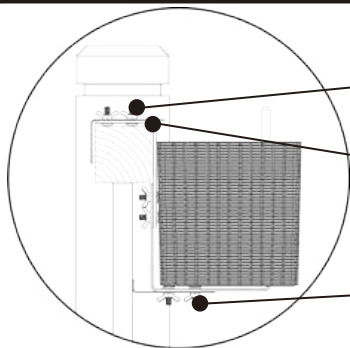

After attaching the lower brace, adjust the top brace to fit over the railing and screw it into place.

This part of the brace secures the window box and can slide backward and forward to accommodate placement.

Install the wing nut and washer underneath the bracket first to help keep the window box secure.

Please don't hesitate to contact us for any further questions,
your satisfaction is guaranteed.

support@aodorshop.com

<https://aodorshop.com/>