

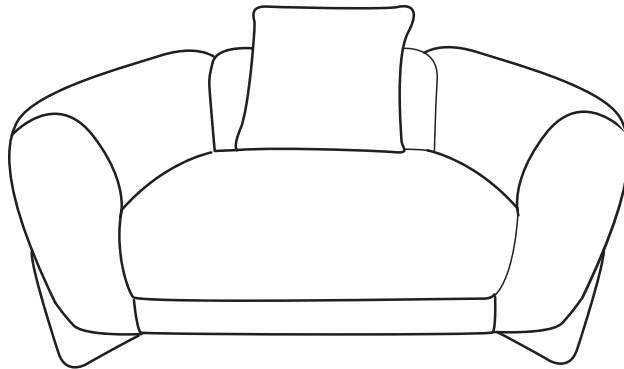

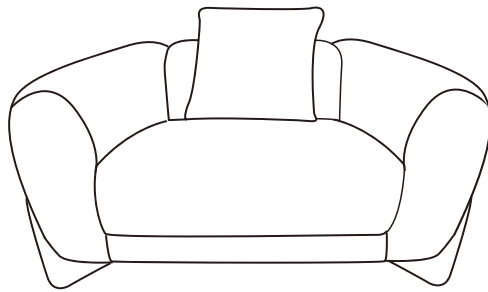

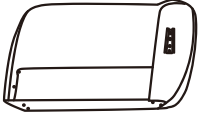



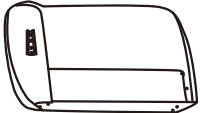

CLOUD CHAIR

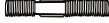
ASSEMBLY
INSTRUCTIONS



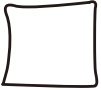

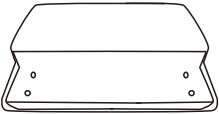
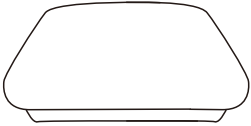
ID	PARTS IDENTIFICATION	QTY	Carton	ID	HARDWARE PACKAGE	QTY
A	 LEFT ARM	1 PC	CLOUD-ARM		M8*60MM SCREWS 	9PCS
					ALLEN KEY 	1PC
B	 RIGHT ARM	1 PC			3*22mm WASHER 	5PCS
					M8*80MM SCREWS 	5PCS
					M8 NUT 	5PCS
					φ15mm SPRING SHIM 	5PCS
					3*17mm WASHER 	9PCS
E	 PILLOW	1 PC			ALLEN KEY 	1PC
					 LEG	4PCS
C	 BACK FRAME	1 PC		CLOUD CHAIR		
D	 SEAT	1 PC				

Step 1

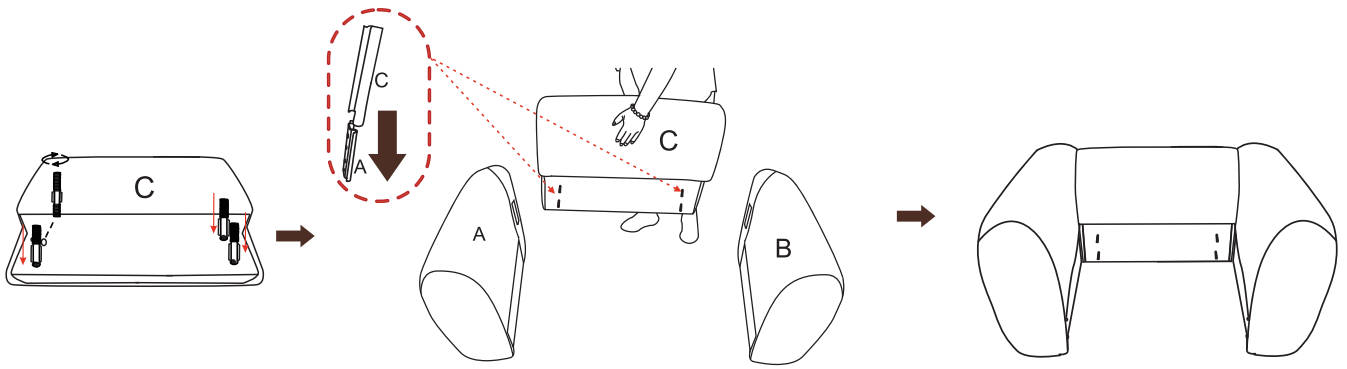

Step 2

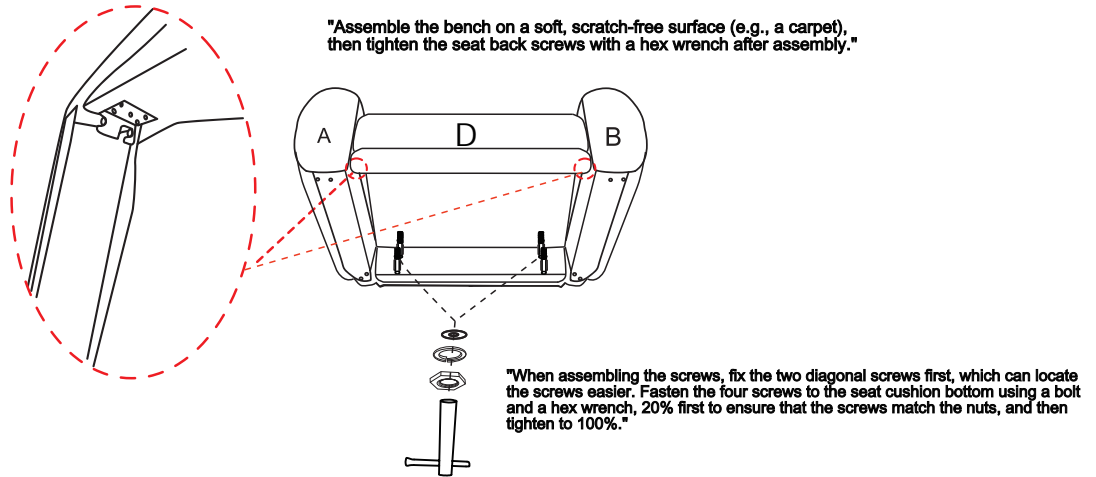

Step 3

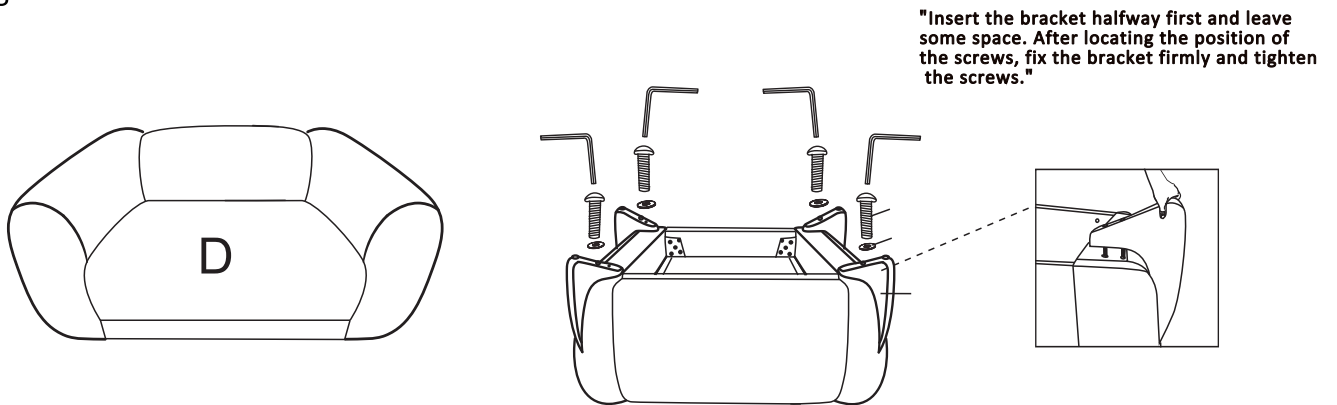

Step 4

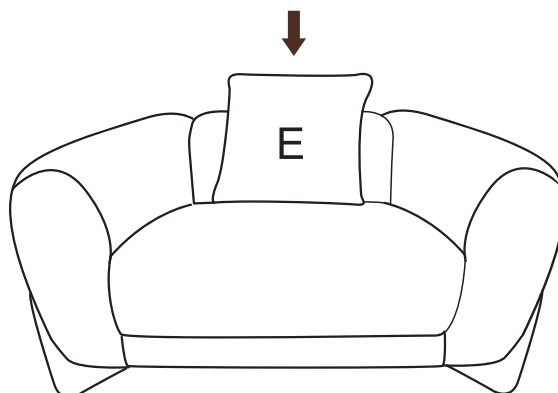

ASSEMBLY INSTRUCTIONS

ASSEMBLY TIPS

1. Remove hardware from box and sort by size.
2. Please check to see that all hardware and parts are present prior to start of assembly.
3. Please follow attached instructions in the same sequence as numbered to assure fast & easy assembly.



WARNING!

1. Don't attempt to repair or modify parts that are broken or defective. Please contact the store immediately.
2. This product is for home use only and not intended for commercial establishments.

ASSEMBLY TIME: 15 MINUTES

