

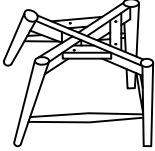





ASSEMBLY INSTRUCTION

24" COUNTER HEIGHT CHAIR

A Leg Frame	B Seat	C Bolt 1/4" x 1-1/2"	D Lock Washer 1/4"
			
1PC	1PC	4PCS	4PCS
E Flat Washer 1/4" x 16mm	F Allen Key 4mm		
			
4PCS	1PC		

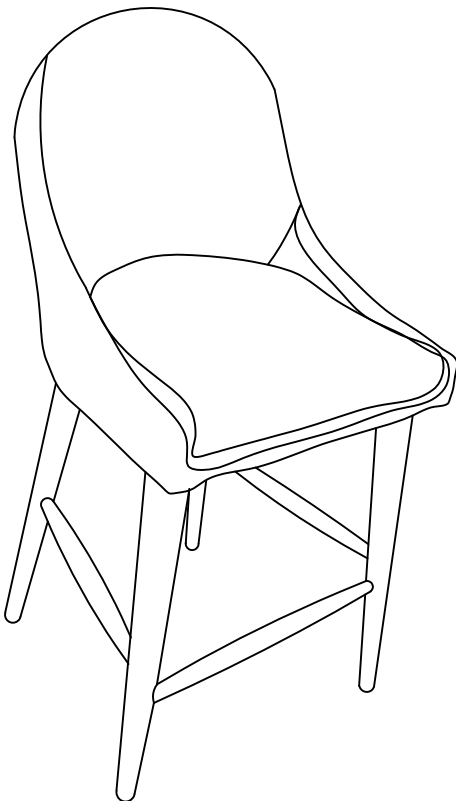

This page lists all the contents included in the box. Please take the time to identify the hardware as well as the individual components to this product. As you unpack and prepare for assembly, place the contents on a carpeted or padded area to protect them from damage.

1

Attach Leg Frame (A) to Seat (B) by using Flat Washer (E), Lock Washer (D), and Bolt (C) with Allen Key (F).

Take the Allen Key, and turn the bolts until the legs are secured. **DO NOT TIGHTEN COMPLETELY.** Stop when you feel you are adding force to tighten the bolt.

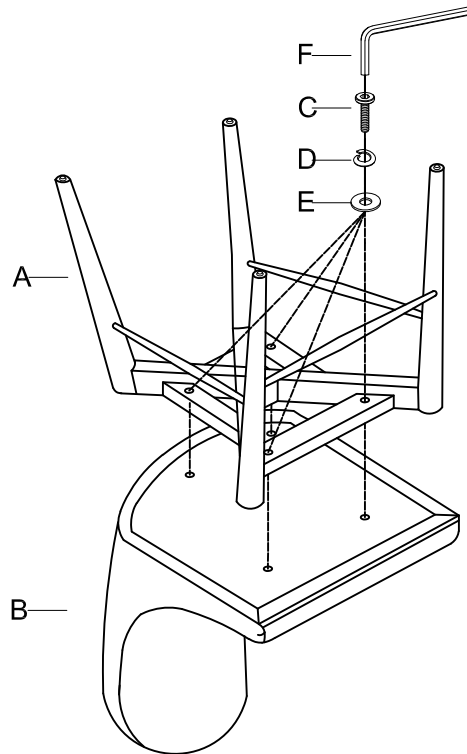

Stand chair up on an even surface and check that it is balanced. If there is a slight wobble, apply downward pressure in the corner where a leg is uneven. Keeping pressure in that corner, tighten all bolts. If balanced, apply downward pressure evenly in the center and tighten all bolts. Do not over-tighten beyond hole depth.

Helpful Tip:

- Instead of applying downward pressure while reaching under to tighten bolts, have someone sit on the chair while you tighten the bolts.

Cleaning & Care

Treat surface with care. Surface is resistant to scratches but is not scratch resistant. Clean surface with a dry or damp soft cloth. Do not use abrasive cleaners. Hardware may loosen over time. Periodically check that all connections are tight.