

Change from the cot on the single bed.

!!! SAFETY - IMPORTANT !!!

Use single bed only when the child is able to walk independently (recommended from a minimum of 2-3 years of age).

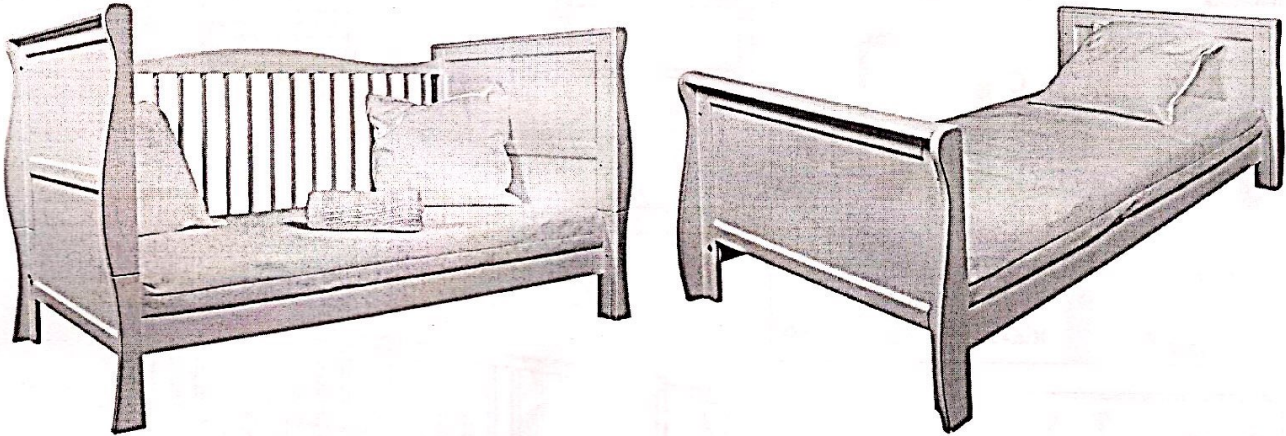

IMPORTANT NOTE - KEEP IN A SAFE PLACE FOR LATER USE READ ATTENTIVELY

Warning notes:

- **WARNING** - make sure that the children's cot is not placed next to open fire or powerful heat sources, such as electrical heating radiators, gas ovens.
- **WARNING** - do not use the children's cot if any part of it is broken, torn or damaged or even missing. Only use the spare parts recommended by manufacturer.
- **WARNING** - Never leave any objects which could be used as foothold or which could become strangulation and asphyxiation hazards, such as ropes, curtain or drape cords, strings etc. in the children's cot.
- **WARNING** - Never use more than one mattress in the children's cot.
- Once the child is old enough to sit up, only use the lowest position of the cot base because it is safest. Only use the base in this position afterwards.
- The mattress you choose must have a thickness so that the height to be overcome (mattress surface until grid upper edge) is 50cm minimum in the lowest cot base position, and 20cm minimum if the cot base is placed in its highest position. Maximum height of mattress 10cm.
- Please use a mattress of a length of 120cm and width of 60cm for this children's cot.
- The length and width of the mattress may only leave a space of 30mm between mattress and side and end parts of the cot.
- Make sure that the iron fittings for cot assembly are properly fastened. Check at regular intervals and retighten if necessary.
- To eliminate the risk of falls, never use the children's cot for a child who can climb out of the children's cot.
- When taking out the removable bars, always remove all of the removable bars to avoid inadmissible dimensions of opening.
- Important note: Never push the cot on its feet, but lift it for transport.

Maintenance and care:

- You will benefit longer from your mattress if you put a mattress protector underneath and use an additional lining. If you want to pass the cot on to another child, replace the mattress for hygienic reasons.
- The wooden parts are easy to clean. Do not use aggressive cleaning agents to remove dirt. In most cases it is sufficient to wipe them down with a moist cloth or sponge.

COT & JUNIOR BED 120x60cm

JULIA_LUX

ASSEMBLY INSTRUCTION SEFETY INFORMATION

M6x55

HWI 6,3x50

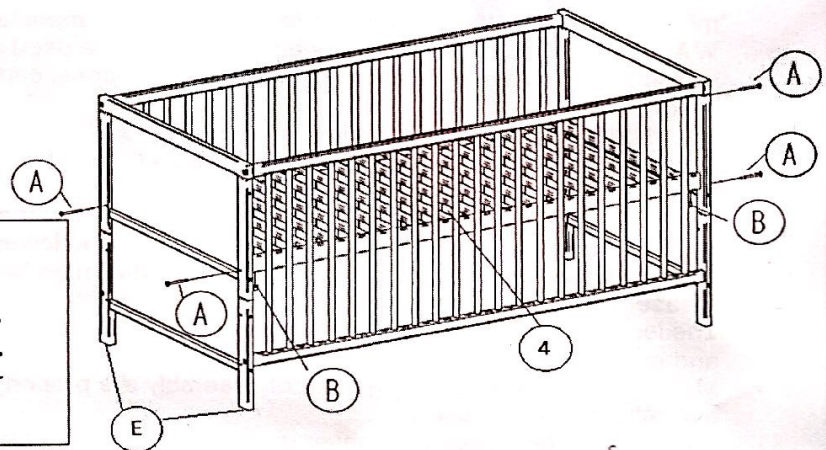
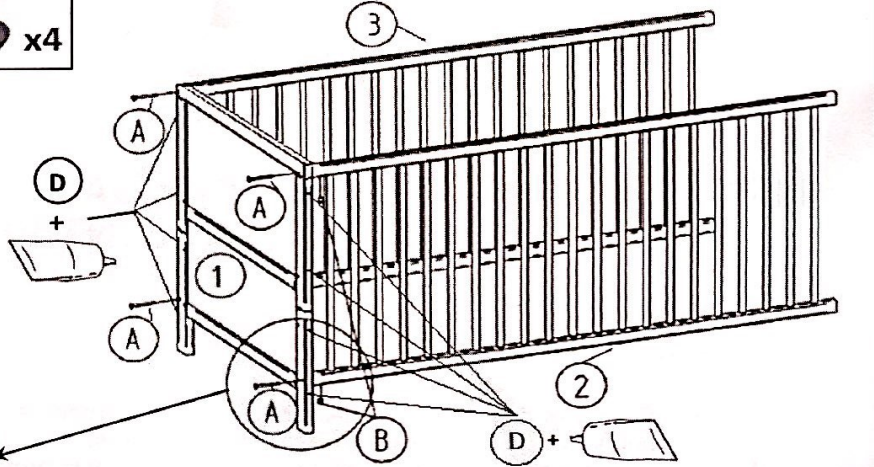
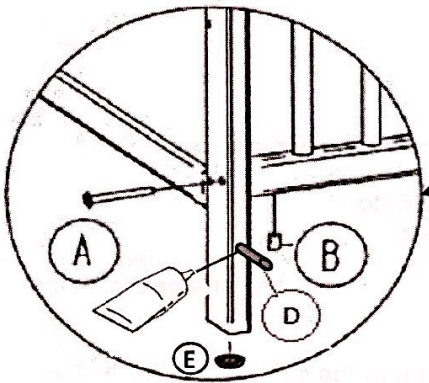
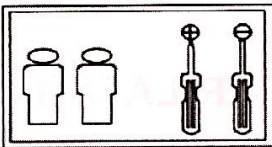
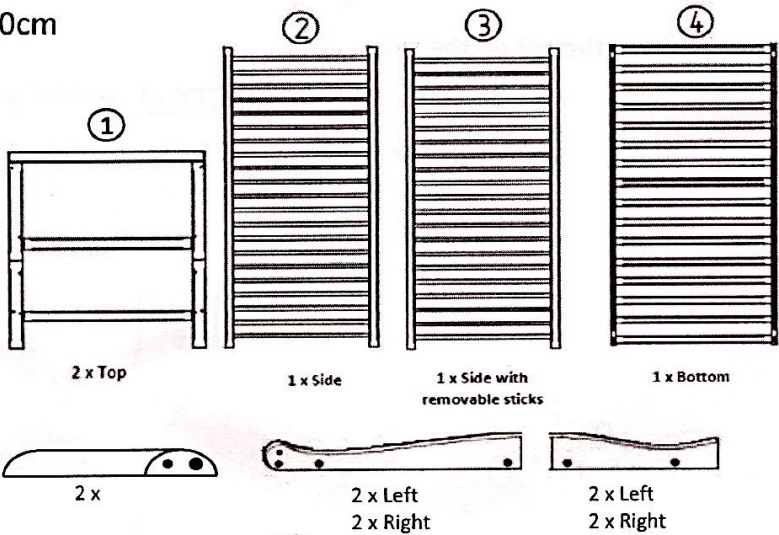
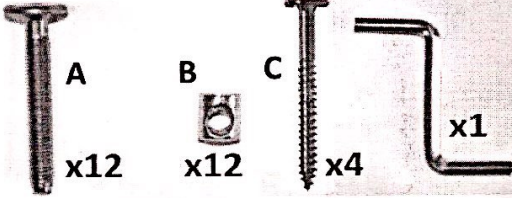

IMPORTANT:

**PUT THE GLUE ALWAYS TO THE HOLES !!!
THEN PUT WOOD DOWELS TO THE HOLES.
THE GLUE MUST DRY FOR ABOUT 1 HOUR.
Full strength, the adhesive is achieved after
about 24 hours (at 20°C) !!!**

