

PURPLE LEAF

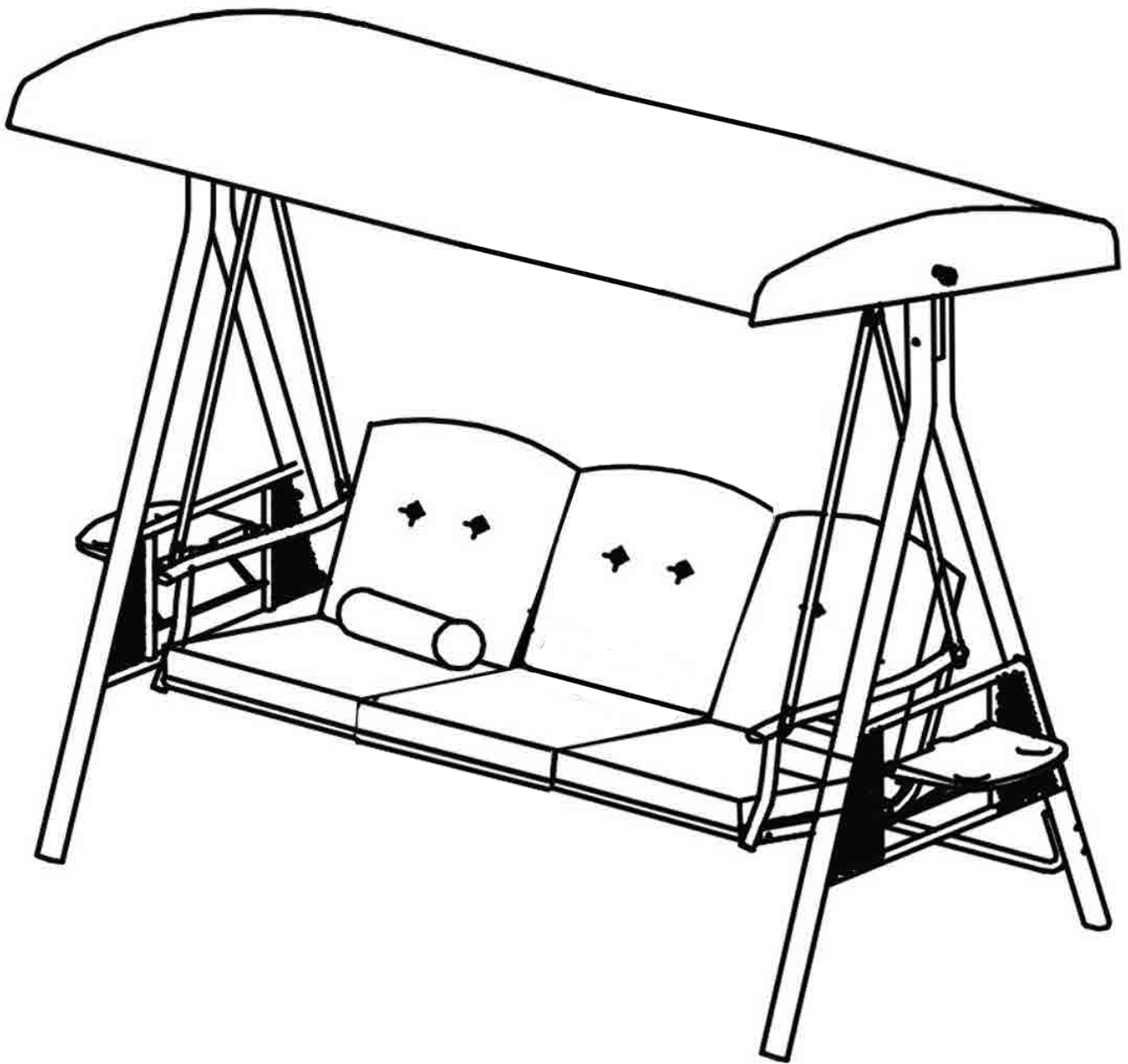















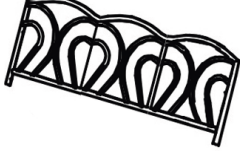

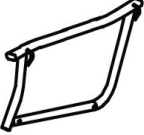
Porch Swing

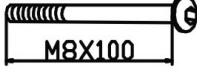
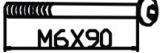
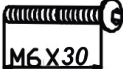
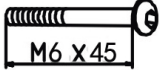
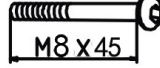
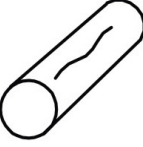
Assembly and Operation

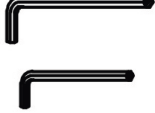

More information at
www.purpleleafgarden.com

CHECK LIST

			
A 2	B 2	C 1	D 2
			
E 4	F 1	G 1	H 1
			
I 2	J 1	J1 1	L 1
			 P 4 
M 4	N 4	O 8	PP 4
			
Q 1	T 3	W M6X4 M8X4	X M6X4 M8X4
			
Y 2	Z M6X4 M8X4	AA 1 1	BB 1

STEP 1

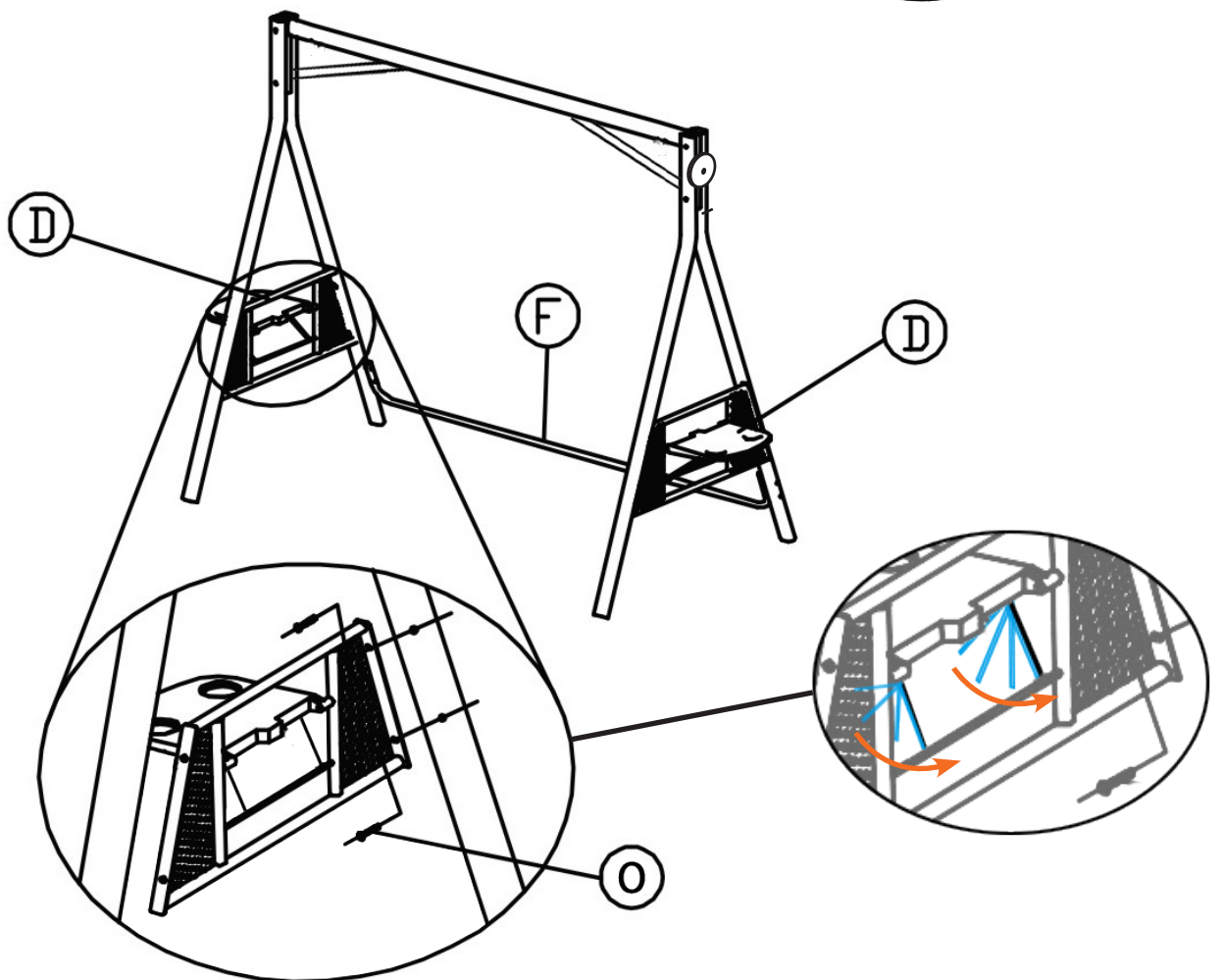
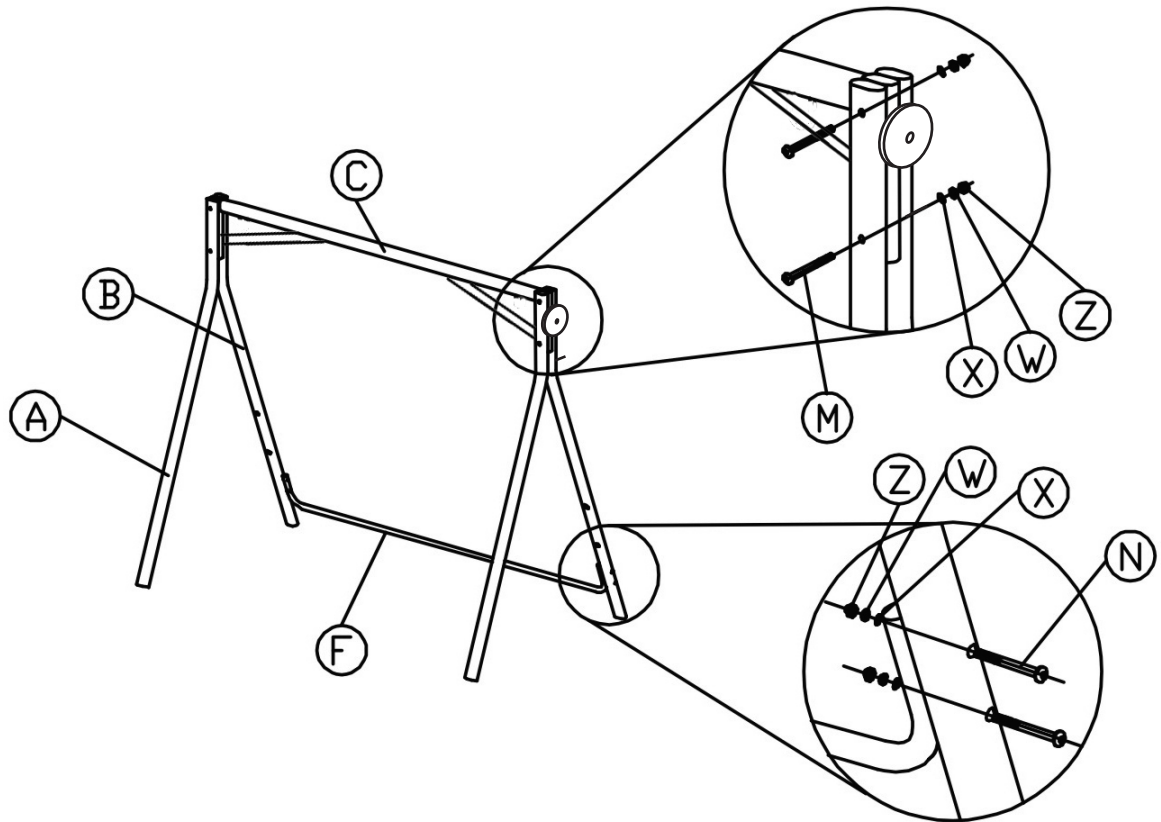

STEP 2

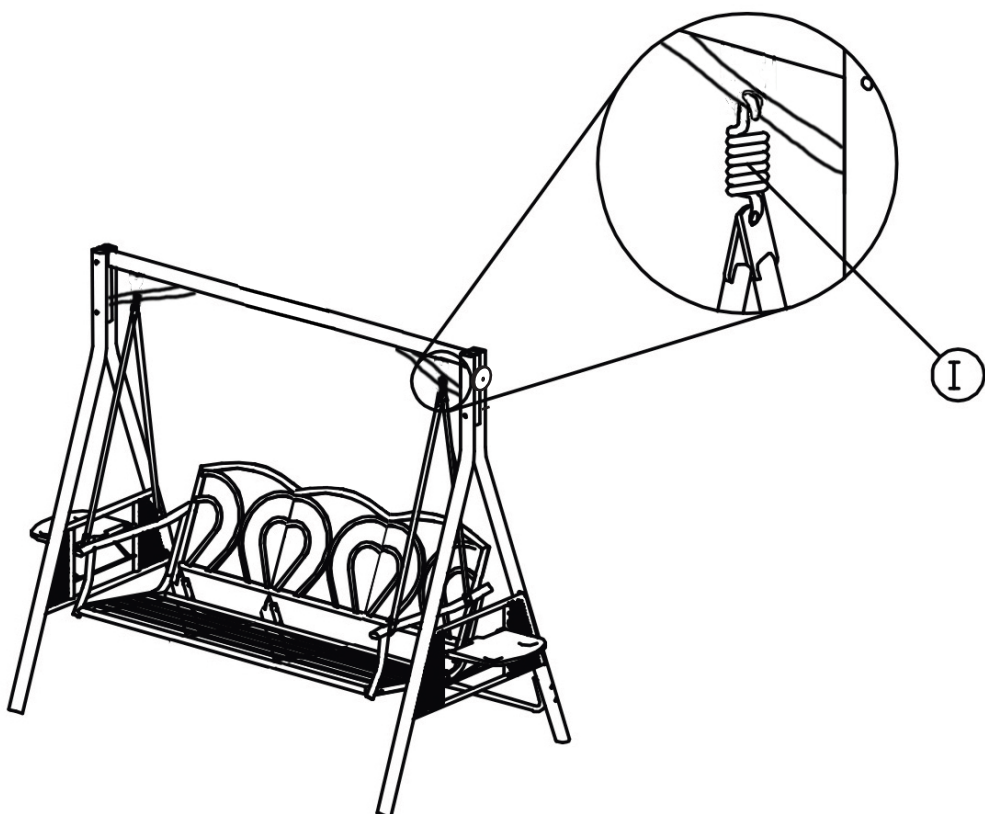
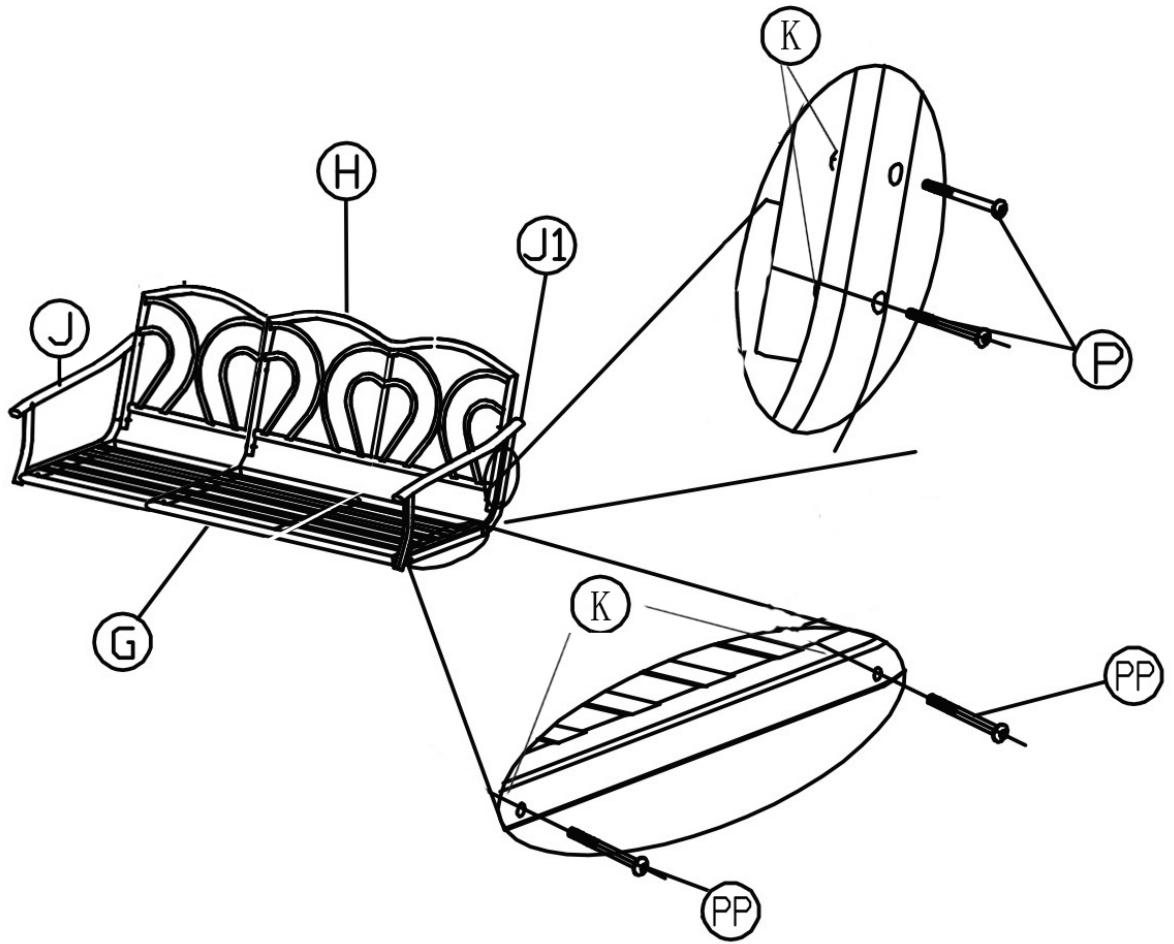

STEP 3

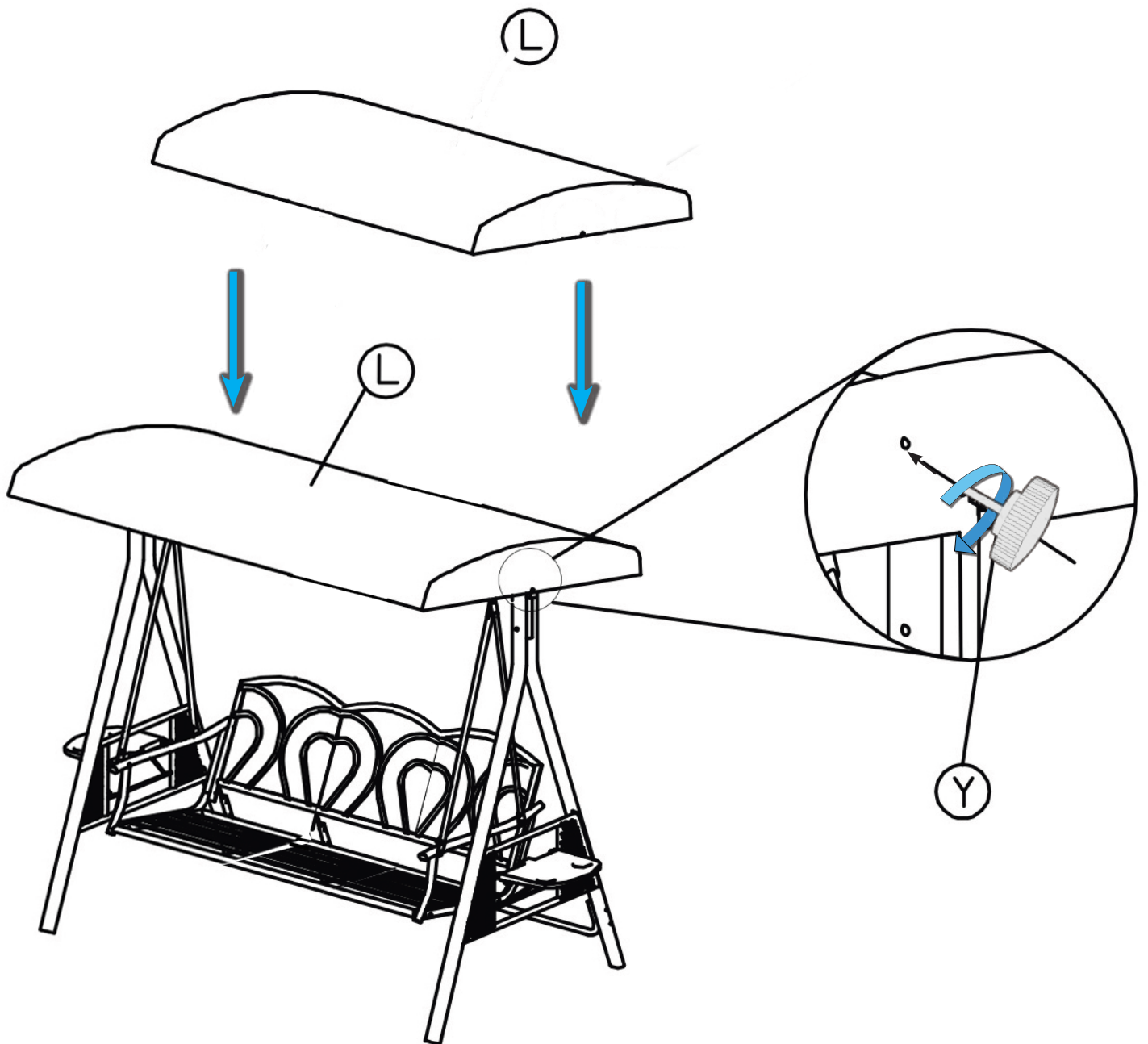

STEP 4

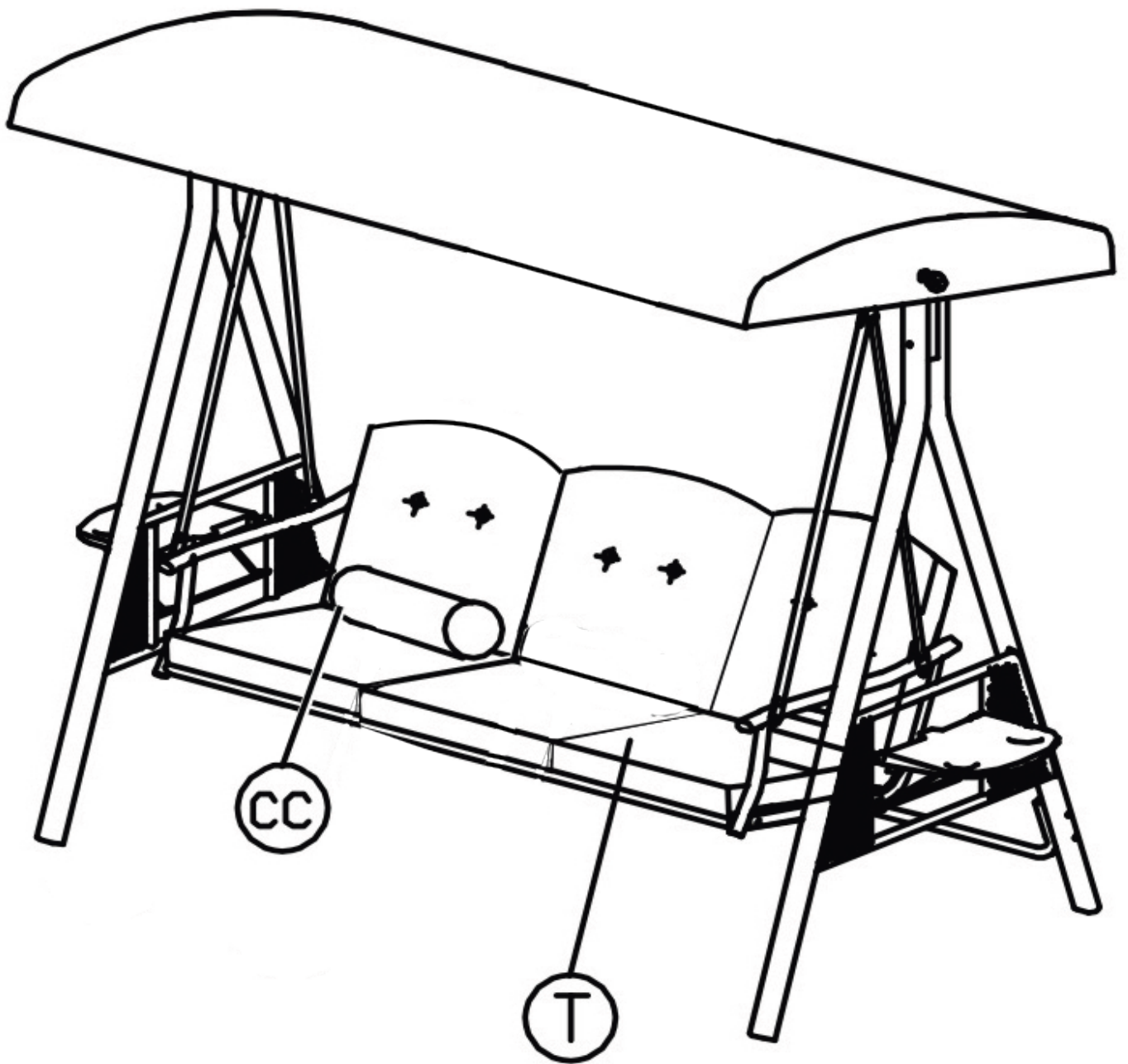

Care and Cleaning

Wash frame parts and fabric with mild soap and water, rinse thoroughly.

Dry frame completely and allow the fabric to drip dry.

Do not use bleach, acid, or other solvents on the fabric or frame parts.

Please inspect and tighten all bolts or fasteners on a regular basis to ensure proper performance and safety of your swing.

Warranty

Frames

Frames constructions are warranted to be free from defects in material and workmanship for 1 year from item purchased. Damage to frame from negligence won't be covered by this warranty.

Cushions & canopy

Cushions & canopy are warranted to be free from defects in material and workmanship for 1 year from item purchased. Damage from exposure to chemicals (including but not only oils ,spills, fluids) won't be covered by this warranty.

Bolts & nuts

Bolts and nuts are warranted to be free from defects in material and workmanship for 1 year from item purchased. Damage from exposure to chemicals (including not only oils ,spills, fluids) won't be covered by this warranty.

Warranty Limitation

This warranty is for the original purchase order only. (Order number required). This warranty is non-transferable. Purple Leaf is responsible for the free replacement part including shipping charges for the 1 year warranty.

Warranty Exclusion

This warranty does not cover products subject to negligence, abuse usage, inappropriate installation. Purple leaf reserves the right to explain warranty exclusions. When the replacement item is applied, the 1 year warranty automatically expires. Please feel free to contact us for applying warranty.



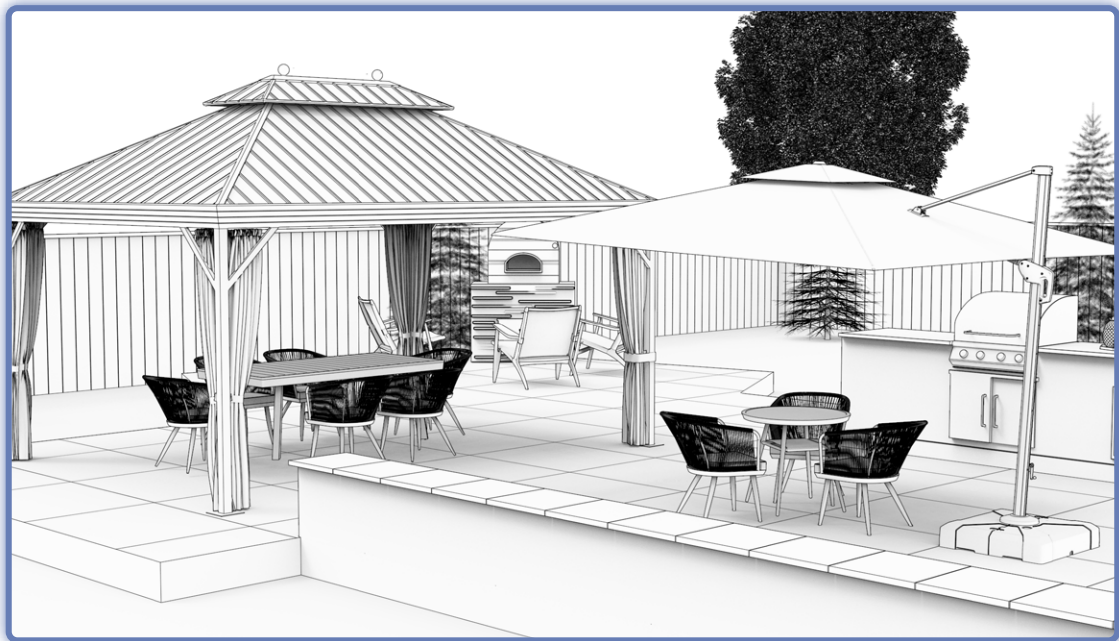
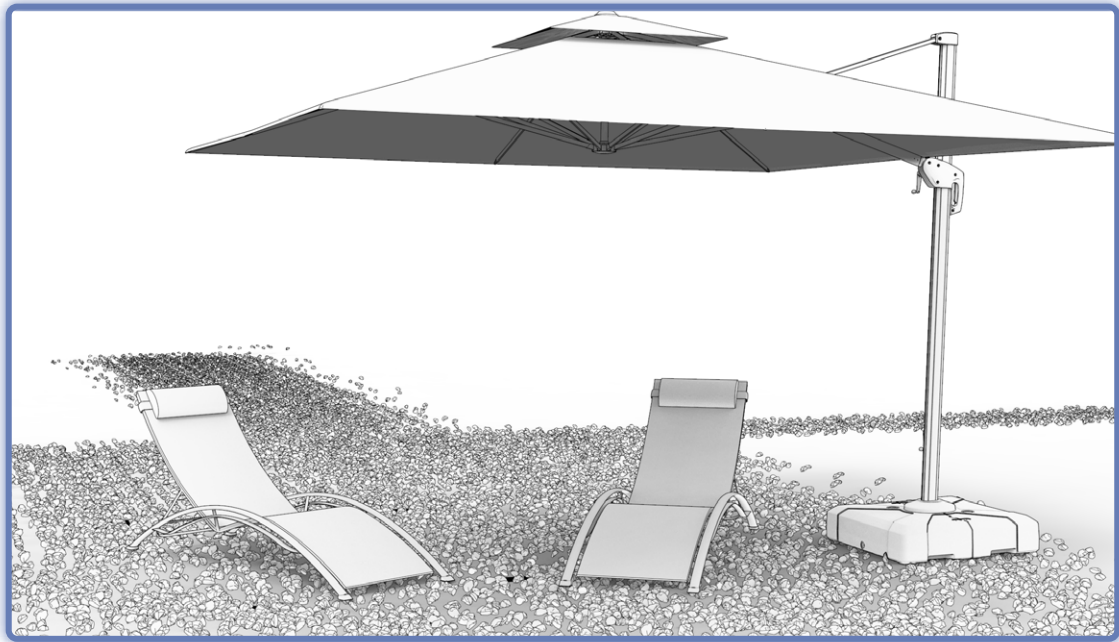

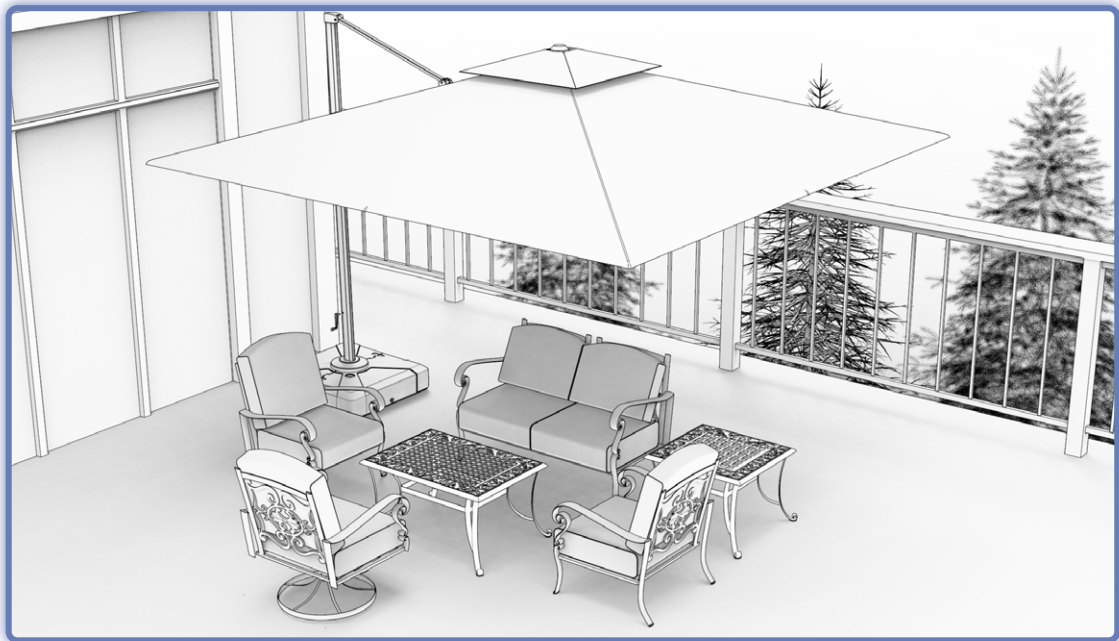

SUPPORT

www.purpleleafgarden.com

swing@purpleleafgarden.com

SOCIAL MEDIA

Follow us on Instagram and Facebook

 www.purpleleafgarden.com/fb

 www.purpleleafgarden.com/ins

Upload a picture of your PURPLE LEAF product in your home, with the hashtag #PURPLE LEAF to receive \$20 PURPLE LEAF Gift Card.



Purple Leaf Inc.

1820 E Locust St, Ontario

CA, 91761, US

©Copyright 2016-2020 Purple Leaf Inc.

All Rights Reserved