







Item	Name	Description	Qty
A	F - Screw 7x60		2
B	F - Screw 7x40		8
C	Nut M8		8
D	Washer Ø20xØ9x1		8
E	Allen Key		2
F	Spanner		1

Step 1 :



Step 2 :

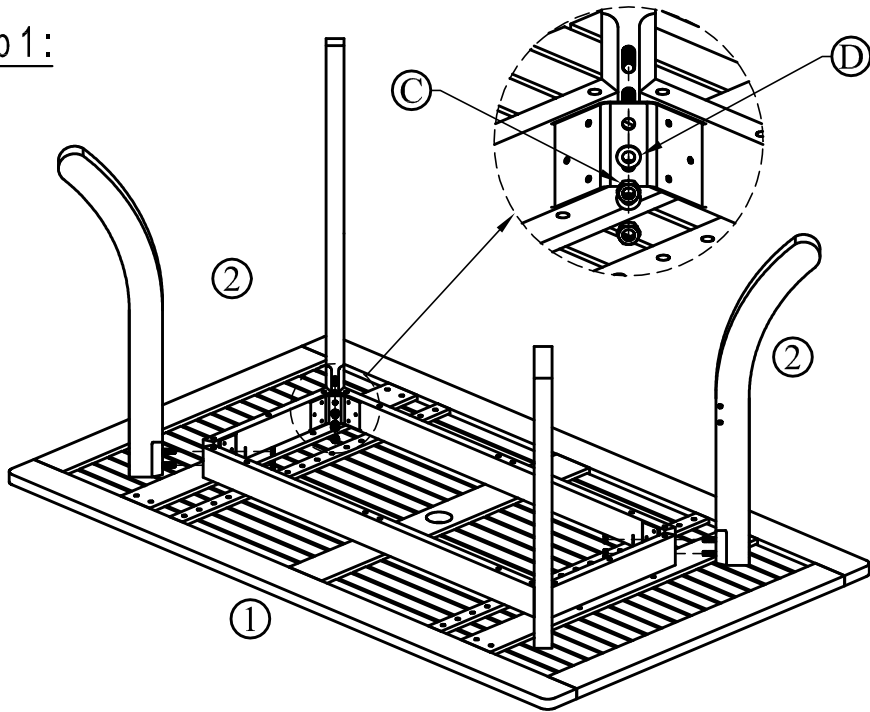