

Assembly Instruction

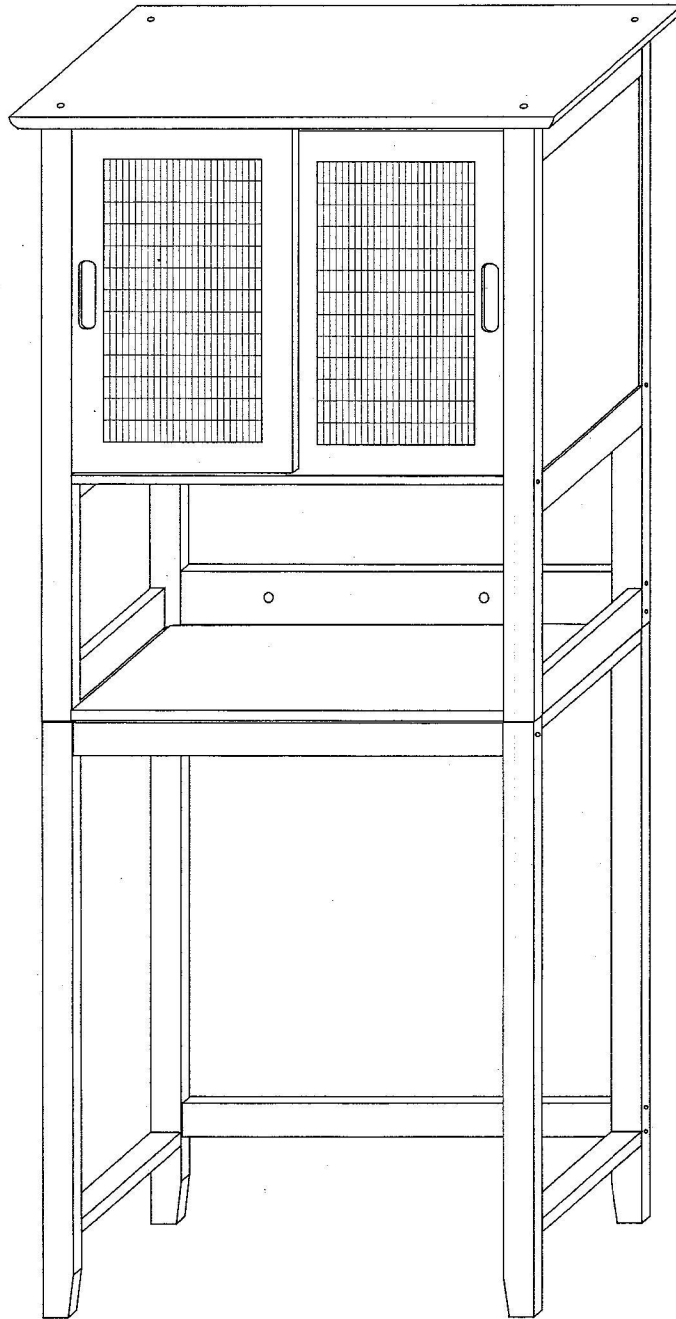







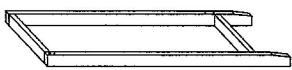
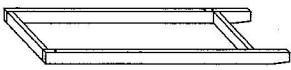
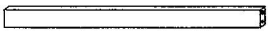

Bamboo Space Saver

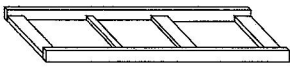
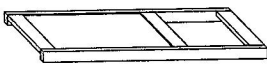



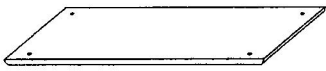
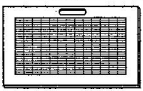

Note:

- 1) Please be advise to have at least 2 persons to assemble this unit.
- 2) Place a large cloth or blanket on the floor surface to protect parts from scratching.
3. Before assembling this unit, please check that all parts and hardware are present.

PART LIST

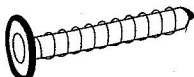
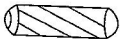
1	 Left Leg	X1
2	 Right Leg	X1
3	 Front Rail	X1
4	 Back Rail	X1
5	 Upper Left Panel	X1
6	 Upper Right Panel	X1
7	 Upper Bottom panel	X1
8	 Upper Back Rail	X1
9	 Shelf	X1
10	 Top Panel	X1
11	 Door Panel	X2
12	 Back Panel	X2
13	 "H" Bar	X1
14	 Middle Panel	X1

HARDWARE LIST

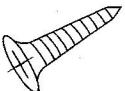
A	 Long Allen Bolt Ø1/4" X 2"	X14
B	 Wood Dowel Ø3/8" X 1-1/2"	X2
C	 Short Allen Bolt Ø1/4" X 1-1/2"	X8
D	 Screw Ø1/8" X 3/8"	X16
E	 Plastic Instart Pin Ø1/4" X 1-1/2"	X2
F	 Allen Wrench Ø1/8" X 2-1/2"	X1
G	 Wall Screw Ø1/8" X 1-1/2"	X2

Step 1

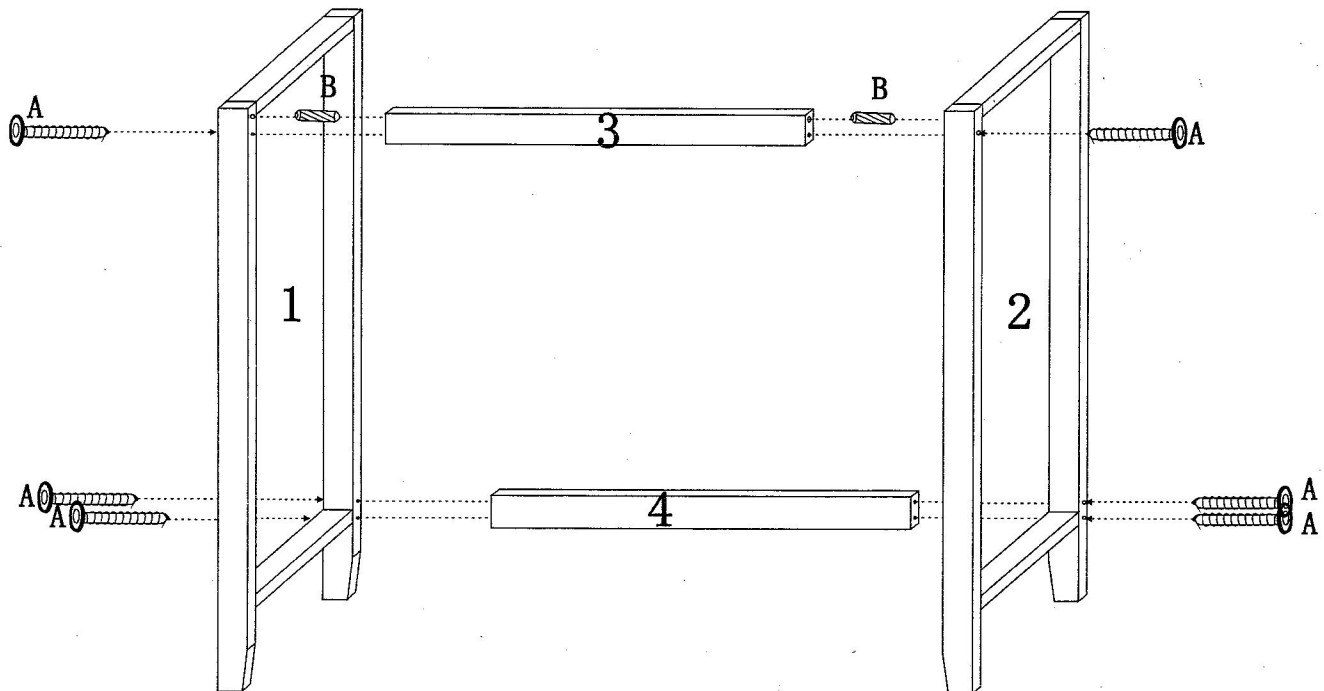

Assemble the Front Rail(3), Back Rail(4) to Left Leg(1) and Right Leg(2) by using Long Allen Bolt(A) as shown.

Step 2

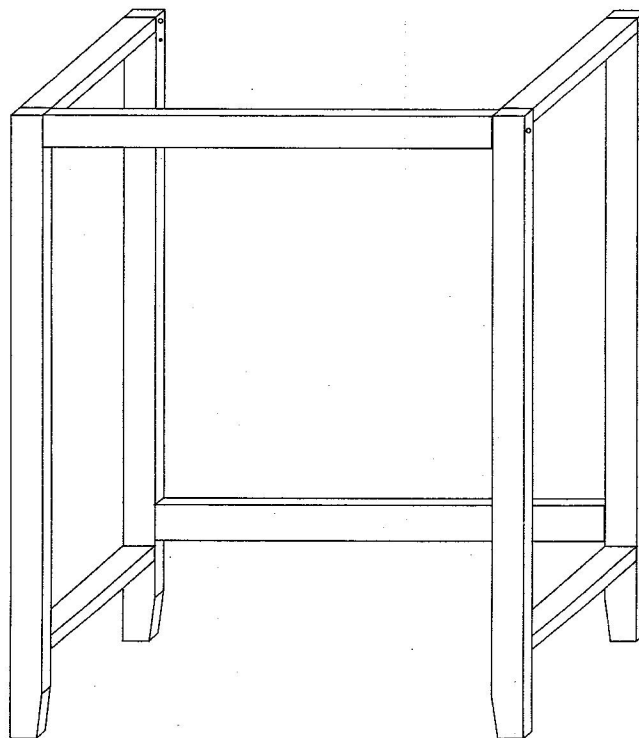

Step 3

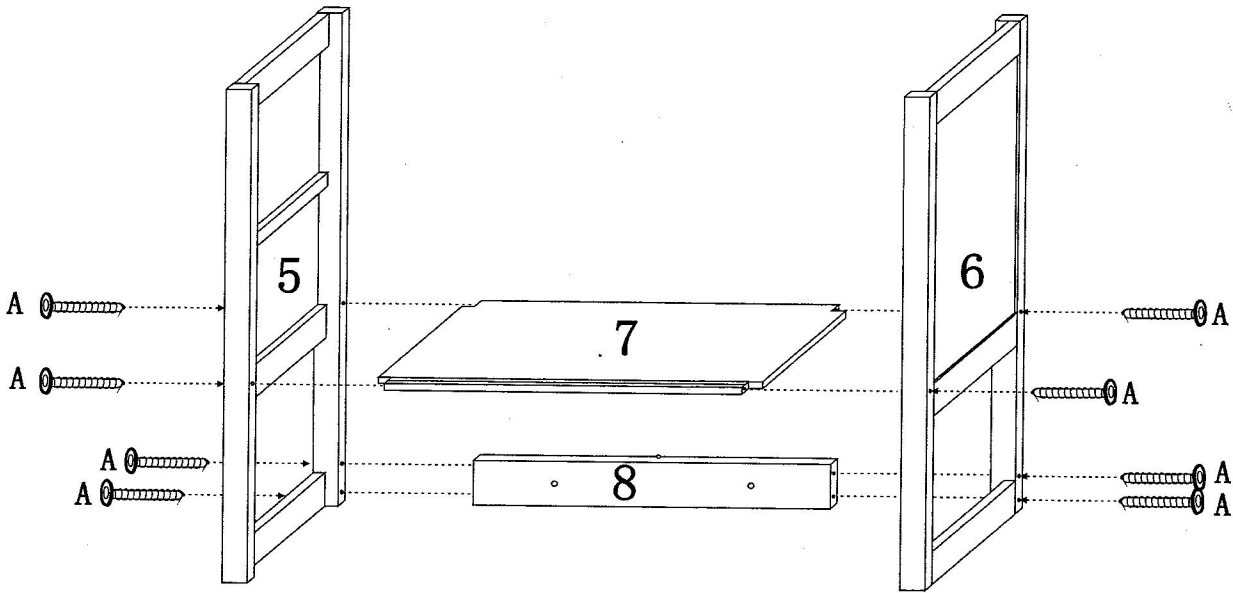

Assemble the Upper Bottom Panel(7), Upper Back Rail(8) to Upper Left Panel(5) and Upper Right Panel(6) by using Long Allen Bolt(A).

Step 4

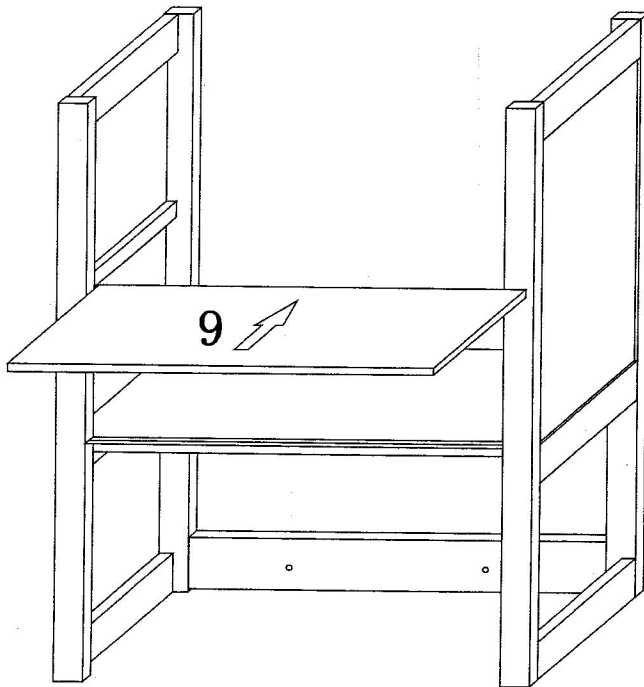

Insert the Shelf(9) as shown.

Step 5

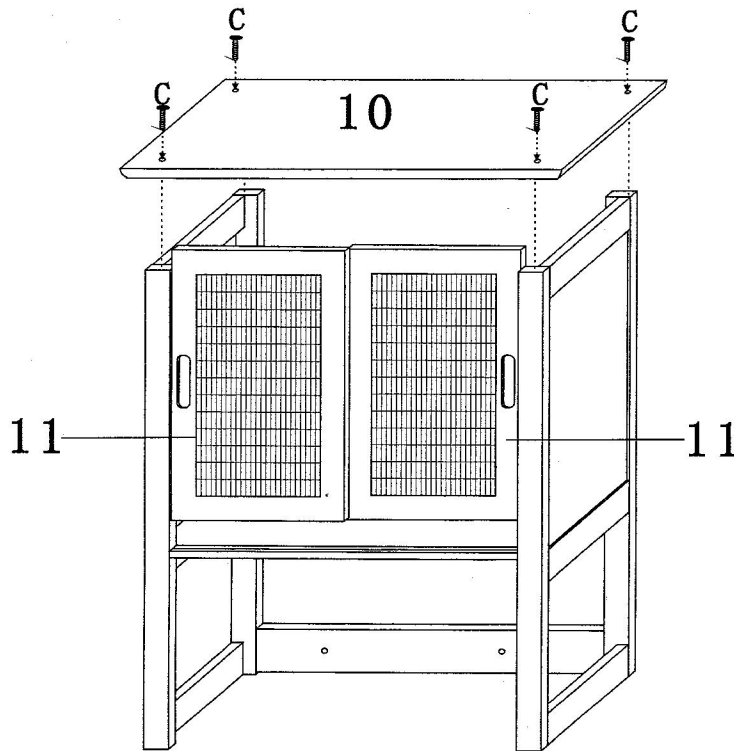

Insert the Door Panel(11) as shown, then assemble the Top Panel(10) to assembled unit by using Short Allen Bolt(C)

Step 6

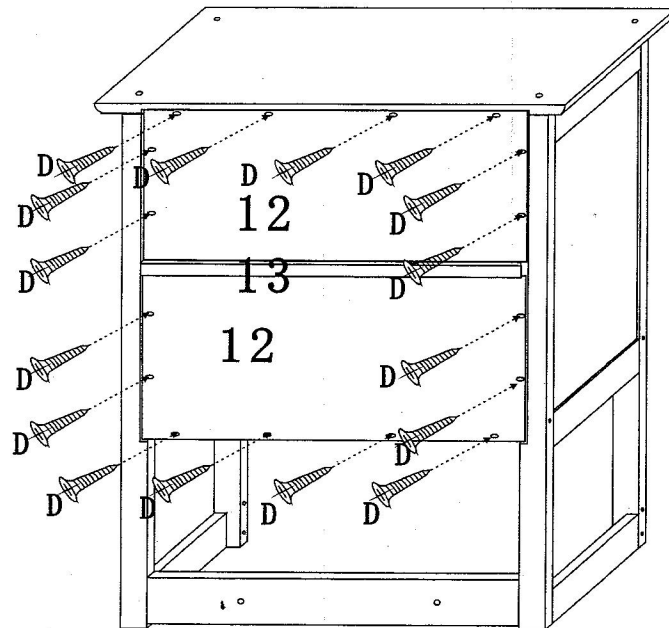

Assemble the Back Panel(12) to assembled unit by using "H" Bar(13) and Screw(D) as shown.

Step 7

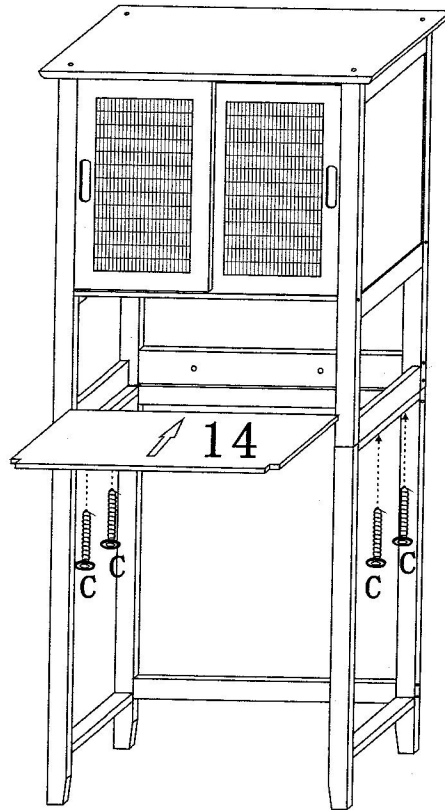

Assemble the Top Part to the Bottom Part by using Short Allen Bolt(C) as shown. Insert the Middle Panel(14) to the assembled unit.

Step 8

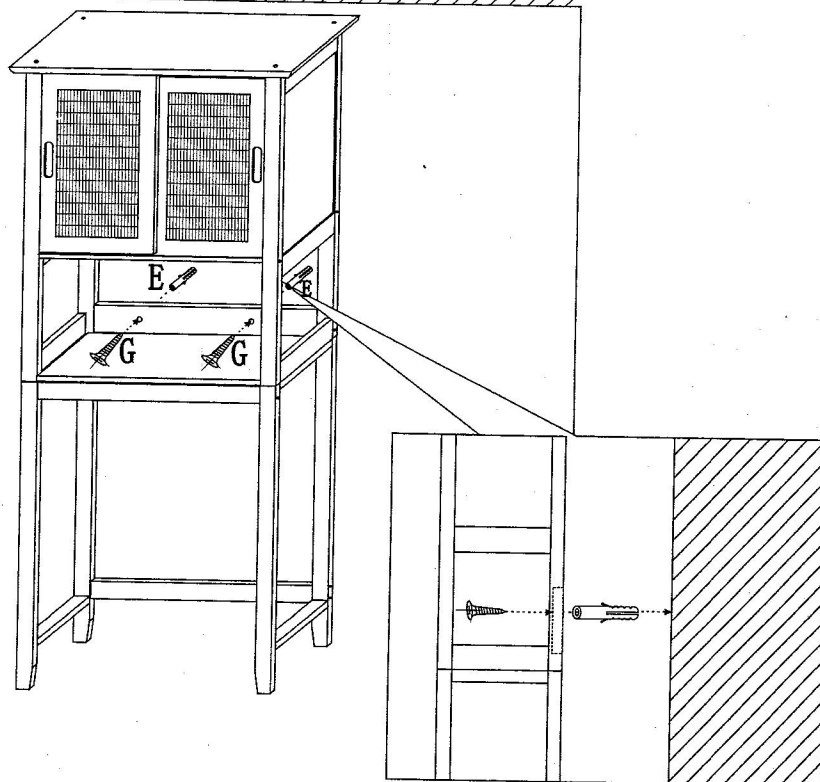

Pre-drill the hole at wall, insert the Plastic Insert Pin(E), then assemble the Bamboo Space Saver to wall by using Wall Screw(G).