

# INSTALLATION MANUAL

TS001-NR-RJ

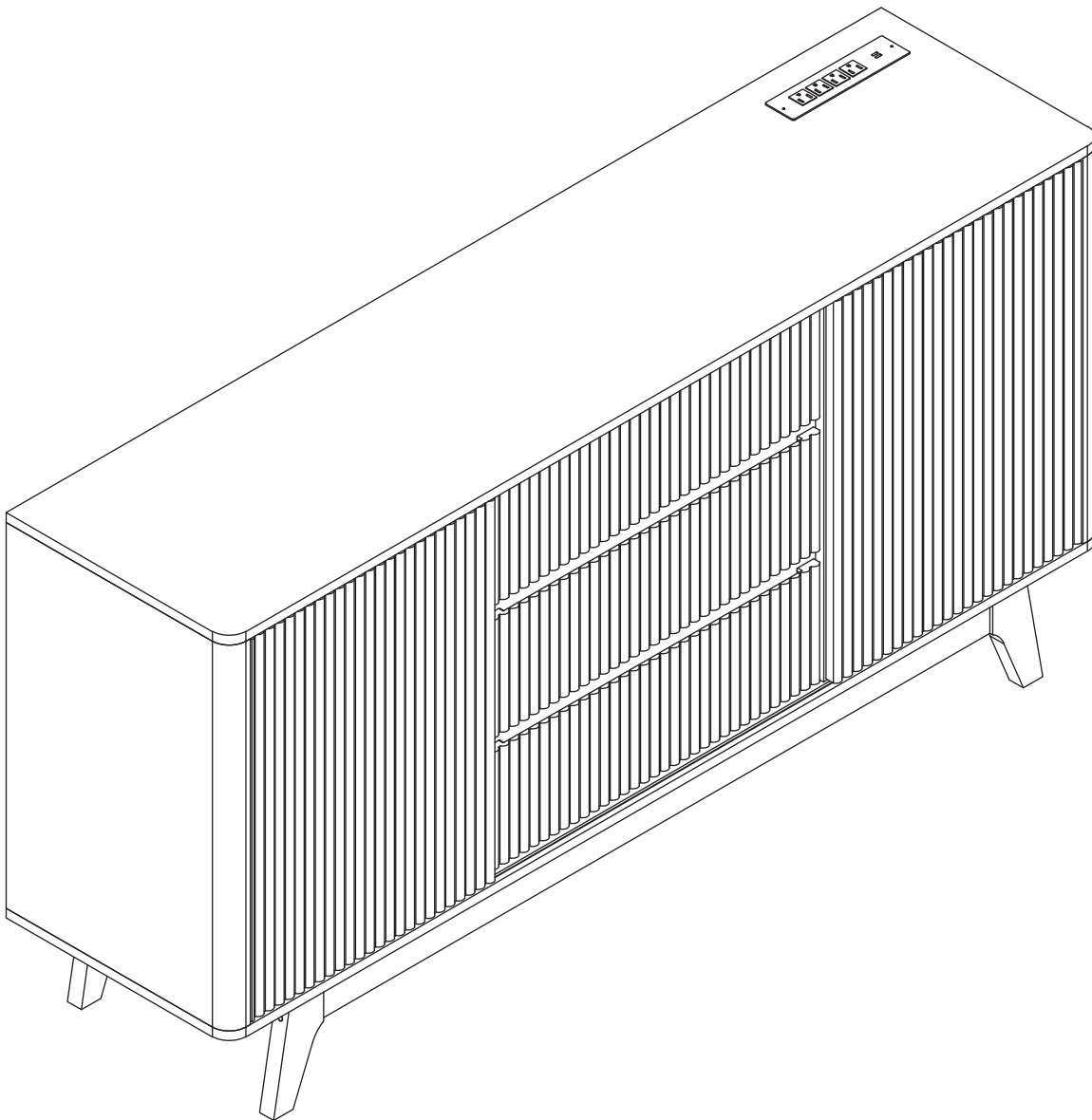

[support@Yanosaku.com](mailto:support@Yanosaku.com)

# NOTICE

IMPORTANT, RETAIN FOR FUTURE REFERENCE: READ CAREFULLY  
WICHTIG, FÜR SPÄTERE NACHSCHLAGE AUFBEWAHREN: SORGFÄLTIG LESEN  
IMPORTANTE, GUARDAR PARA REFERENCIA FUTURA: LEER ATENTAMENTE  
IMPORTANTE, CONSERVARE PER RIFERIMENTI FUTURI: LEGGERE ATTENTAMENTE  
IMPORTANT, À CONSERVER POUR RÉFÉRENCE FUTURE : LIRE ATTENTIVEMENT

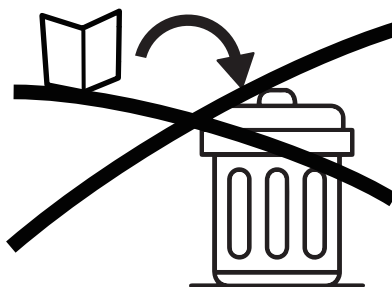
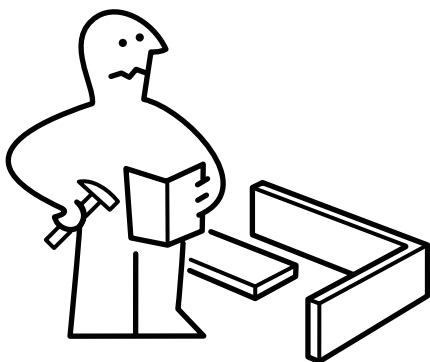

Assemble on a flat, clean and soft surface.

Auf einer flachen, sauberen und weichen Oberfläche zusammenbauen.

Assembler sur une surface plate, propre et douce.

Assemblare su una superficie piatta, pulita e morbida.

Ensamblar sobre una superficie plana, limpia y suave.

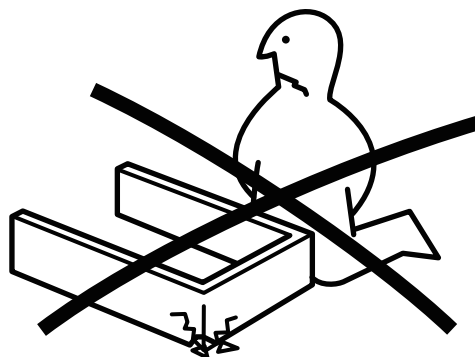
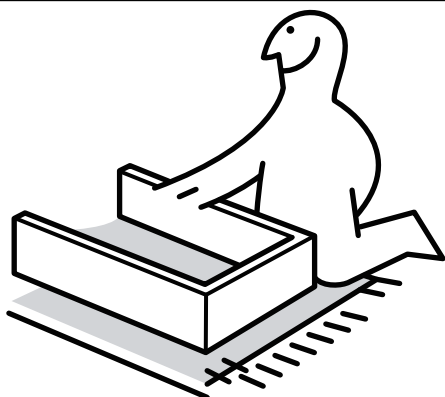

Professional installation is highly recommended.

Eine professionelle Installation wird dringend empfohlen.

Une installation professionnelle est fortement recommandée.

Si raccomanda vivamente l'installazione professionale.

Se recomienda altamente la instalación profesional.



Periodically check that all components are tightly secured.

Überprüfen Sie Regelmäßig, Dass Alle Komponenten Fest Gesichert Sind.

Vérifiez Périodiquement Que Tous Les Composants Sont Bien Fixés.

Controllare Periodicamente Che Tutti I Componenti Siano Ben Fissati.

Verifique Periódicamente Que Todos Los Componentes Estén Bien Asegurados.

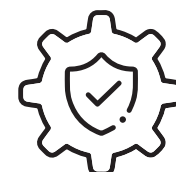

It is recommended that multiple people assemble this product.  
Es wird empfohlen, dass mehrere Personen dieses Produkt zusammenbauen.  
Il est recommandé que plusieurs personnes assemblent ce produit.  
Si raccomanda che più persone assemblino questo prodotto.  
Se recomienda que varias personas ensamblen este producto.

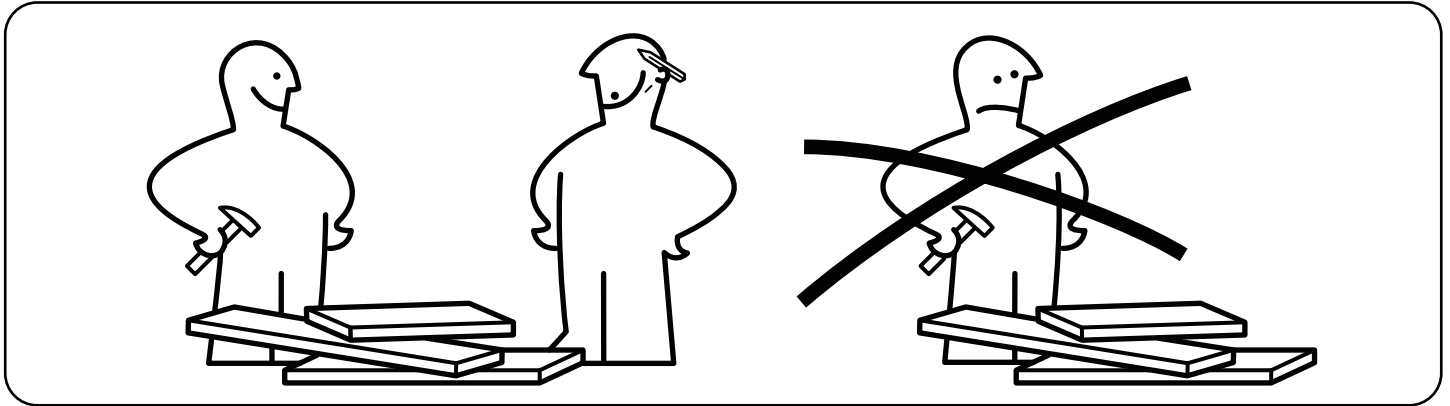

Press And Hold The Drawer Runner Lock And Then Continue To Slide Drawer Runners Apart Before Installation.

Drücken Und Halten Sie Die Schubladenauszugssperre Und Schieben Sie Dann Die Schubladenauszüge Auseinander, Bevor Sie Installieren.

Pressez Et Maintenez Le Verrou Du Coulisseau Du Tiroir, Puis Continuez À Écarter Les Coulisses Du Tiroir Avant L'installation.

Premere E Tenere Premuto Il Blocco Della Guida Del Cassetto, Quindi Continuare A Scorrere Le Guide Del Cassetto Separatamente Prima Dell'installazione.

Presione Y Mantenga Presionado El Bloqueo Del Corredor Del Cajón Y Luego Continúe Deslizando Los Corredores Del Cajón Por Separado Antes De La Instalación.

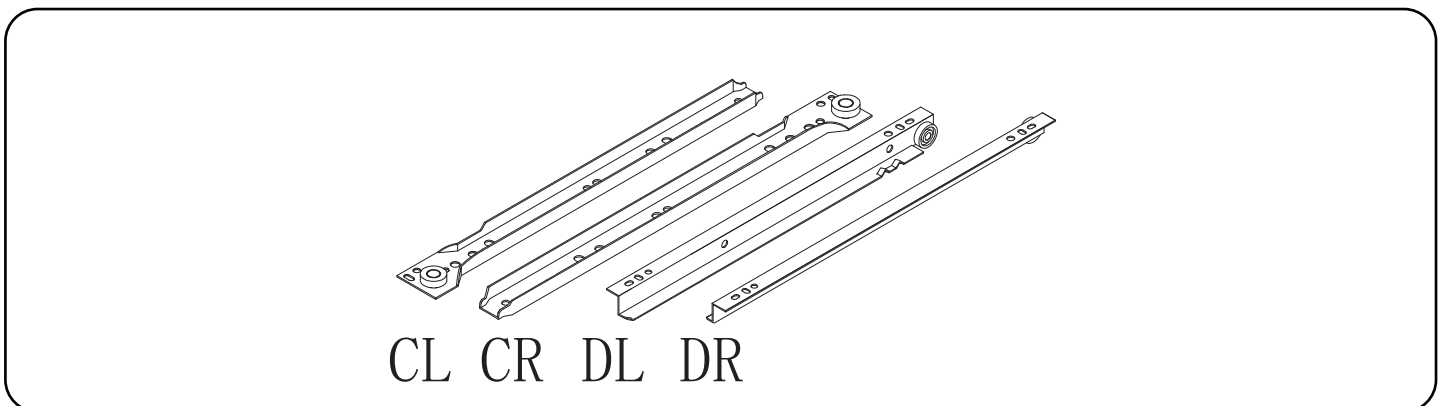

Please have the following auxiliary tools ready:  
Bitte halten Sie folgende Hilfswerkzeuge bereit:  
Veuillez préparer les outils auxiliaires suivants :  
Si prega di avere pronti i seguenti strumenti ausiliari:  
Por favor, tenga listas las siguientes herramientas auxiliares:

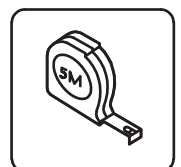
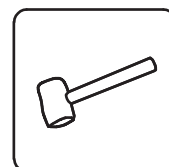

Never let children climb or hang on drawers, doors, or shelves.

Lassen Sie Kinder niemals auf Schubladen, Türen oder Regalen klettern oder hängen.

Ne laissez jamais les enfants grimper ou se suspendre aux tiroirs, portes ou étagères.

Non permettere mai ai bambini di arrampicarsi o appendersi ai cassetti, alle porte o agli scaffali.

Nunca permita que los niños trepen o se cuelguen de los cajones, puertas o estantes.



Serious or fatal crushing injuries can occur from furniture tip-over. Always secure this furniture to the wall using tip-over restraints.

Schwere oder tödliche Quetschverletzungen können durch das Umkippen von Möbeln verursacht werden. Sichern Sie diese Möbel immer mit Kipp-Sicherungen an der Wand.

Des blessures graves ou mortelles par écrasement peuvent survenir en cas de basculement de meubles. Fixez toujours ces meubles au mur à l'aide de dispositifs anti-basculement.

Lesioni gravi o mortali da schiacciamento possono verificarsi a causa del ribaltamento dei mobili. Fissare sempre questi mobili alla parete utilizzando i sistemi di blocco anti-ribaltamento.

Pueden ocurrir lesiones graves o fatales por aplastamiento debido al volcamiento de muebles. Siempre asegure este mueble a la pared utilizando dispositivos anti-vuelco.

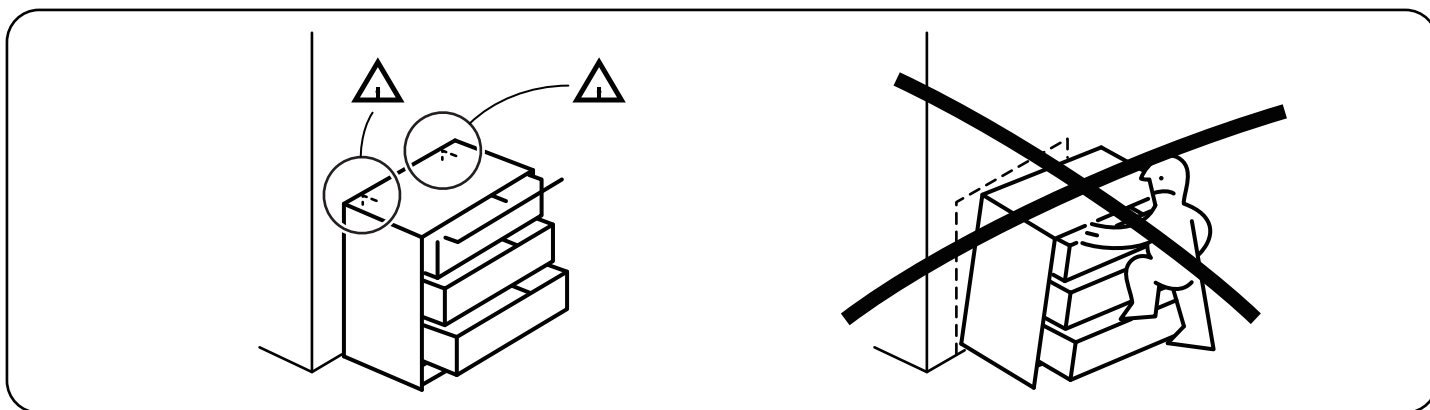

To prevent panel damage during assembly, avoid using power tools and opt for manual tools instead.

Um Schäden an den Paneelen während der Montage zu vermeiden, vermeiden Sie Elektrowerkzeuge und verwenden Sie stattdessen Handwerkzeuge.

Pour éviter d'endommager les panneaux lors de l'assemblage, évitez les outils électriques et utilisez plutôt des outils manuels.

Per prevenire danni ai pannelli durante il montaggio, evita gli utensili elettrici e usa invece utensili manuali.



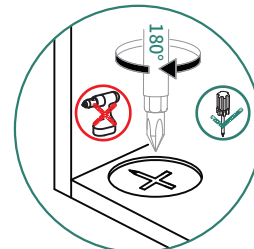
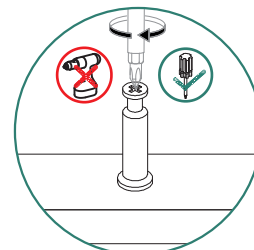

Para prevenir daños en los paneles durante el montaje, evite herramientas eléctricas y use herramientas manuales en su lugar.

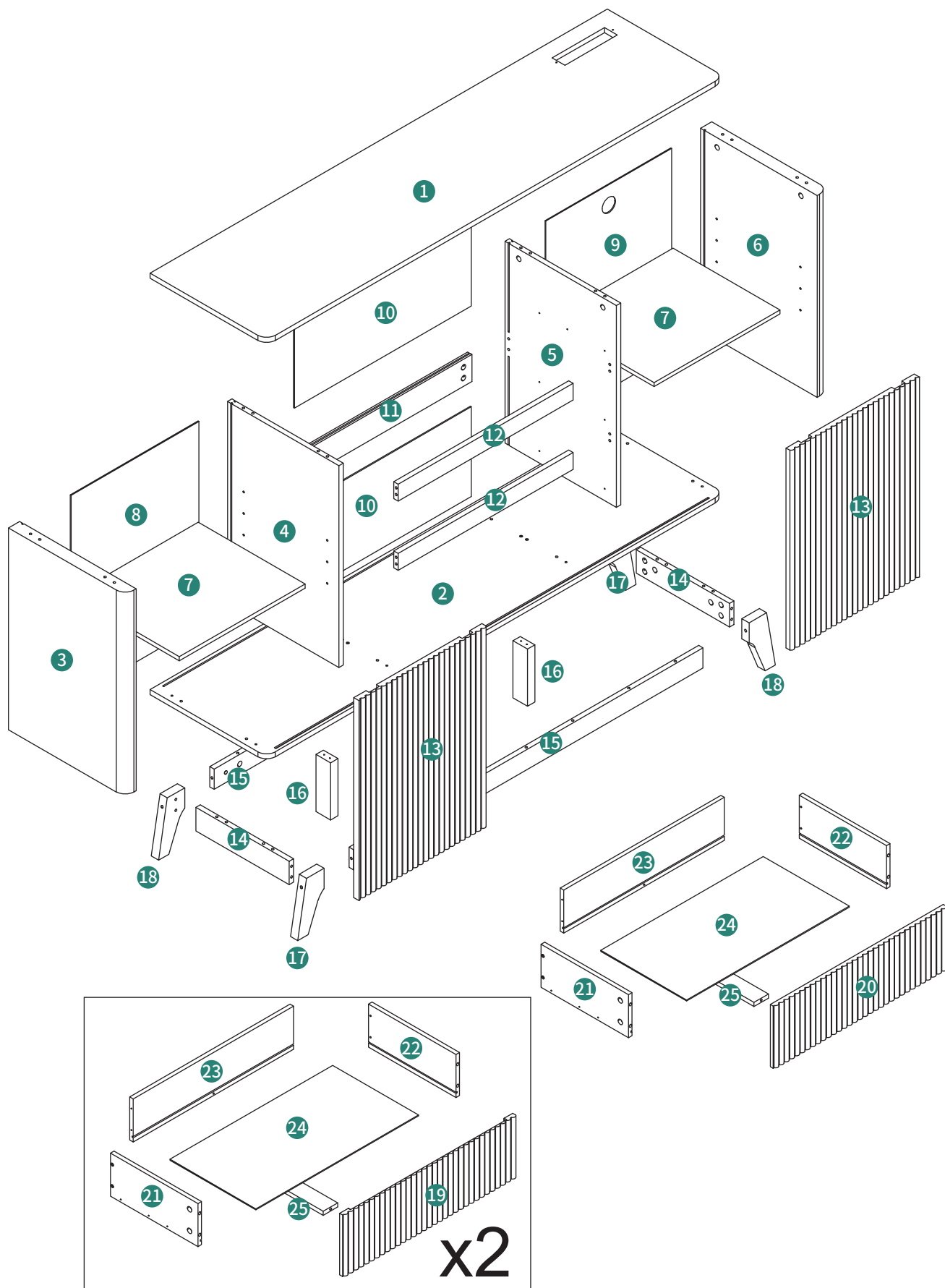



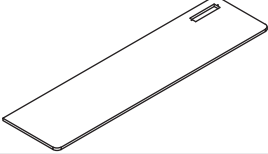
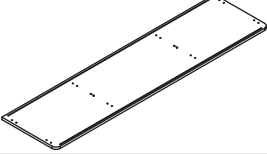
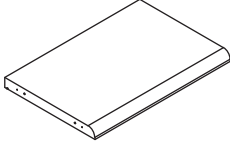
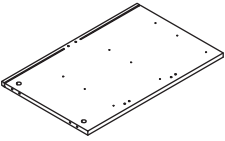
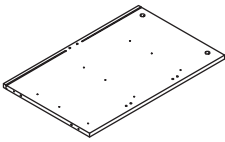
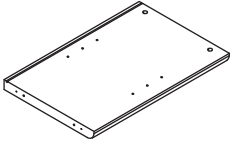
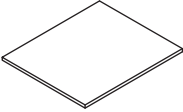
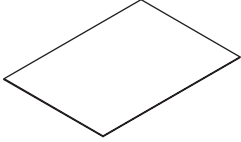
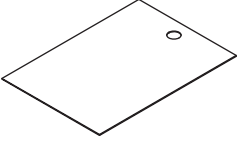
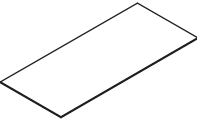
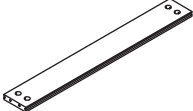
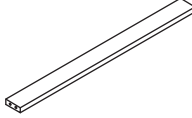
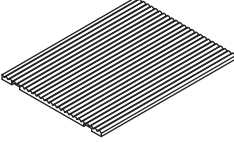
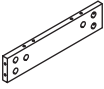
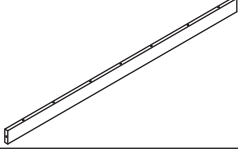



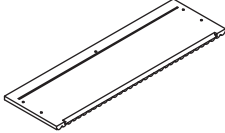
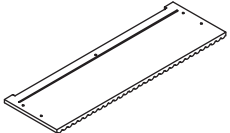

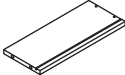
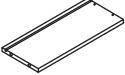
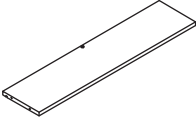
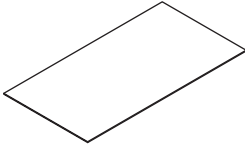
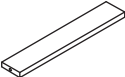
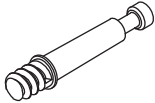

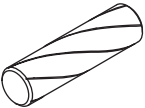
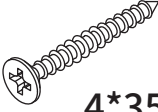
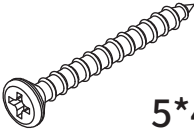
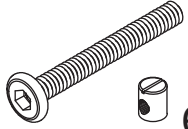
# EXPLODED VIEW

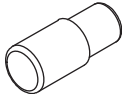

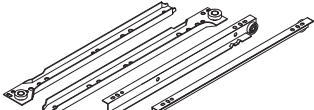
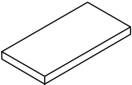
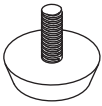
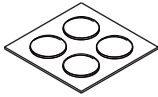
# PARTS

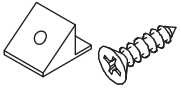
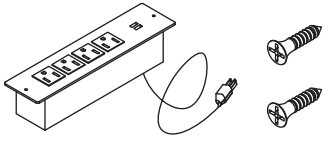
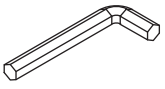
Item no. Nr. N° d'article Articolo No. Artículo No.	Reference Image Referenzbild Image de référence Immagine di riferimento Imagen de referencia	Qty. Menge Qté. Qtà Cant.	Item no. Nr. N° d'article Articolo No. Artículo No.	Reference Image Referenzbild Image de référence Immagine di riferimento Imagen de referencia	Qty. Menge Qté. Qtà Cant.
1		X1	2		X1
3		X1	4		X1
5		X1	6		X1
7		X2	8		X1
9		X1	10		X2
11		X1	12		X2
13		X2	14		X2
15		X2	16		X2
17		X2	18		X2
19		X2	20		X1

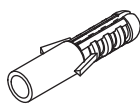
Item no. Nr. N° d'article Articolo No. Artículo No.	Reference Image Referenzbild Image de référence Immagine di riferimento Imagen de referencia	Qty. Menge Qté. Qtà Cant.	Item no. Nr. N° d'article Articolo No. Artículo No.	Reference Image Referenzbild Image de référence Immagine di riferimento Imagen de referencia	Qty. Menge Qté. Qtà Cant.
21		X3	22		X3
23		X3	24		X3
25		X3			
A		X51+4	B		X51+4
C		X30+3	D	 4*35MM	X17+2
E	 5*45MM	X8	F	 6*70MM	X4
G	 3*12MM	X68+5	H		X8
I		X4	J		X4
K	 CL CR DL DR	X3	L		X4
M		X2	N		X4

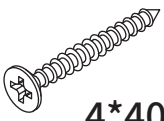
Item no. Nr. N° d'article Articolo No. Artículo No.	Reference Image Referenzbild Image de référence Immagine di riferimento Imagen de referencia		Item no. Nr. N° d'article Articolo No. Artículo No.	Reference Image Referenzbild Image de référence Immagine di riferimento Imagen de referencia	
<b>O</b>		X16	<b>P</b>		X1
<b>Q</b>		X1	<b>R</b>	 4*14MM	X2
<b>S</b>		X4	<b>T</b>		X2
<b>U</b>		X2	<b>V</b>	 4*40MM	X4

# ASSEMBLY

1

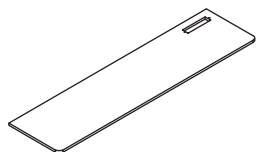

① 1pc

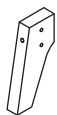

⑱ 2pcs



⑰ 2pcs

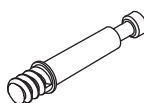

Ⓐ 16pcs

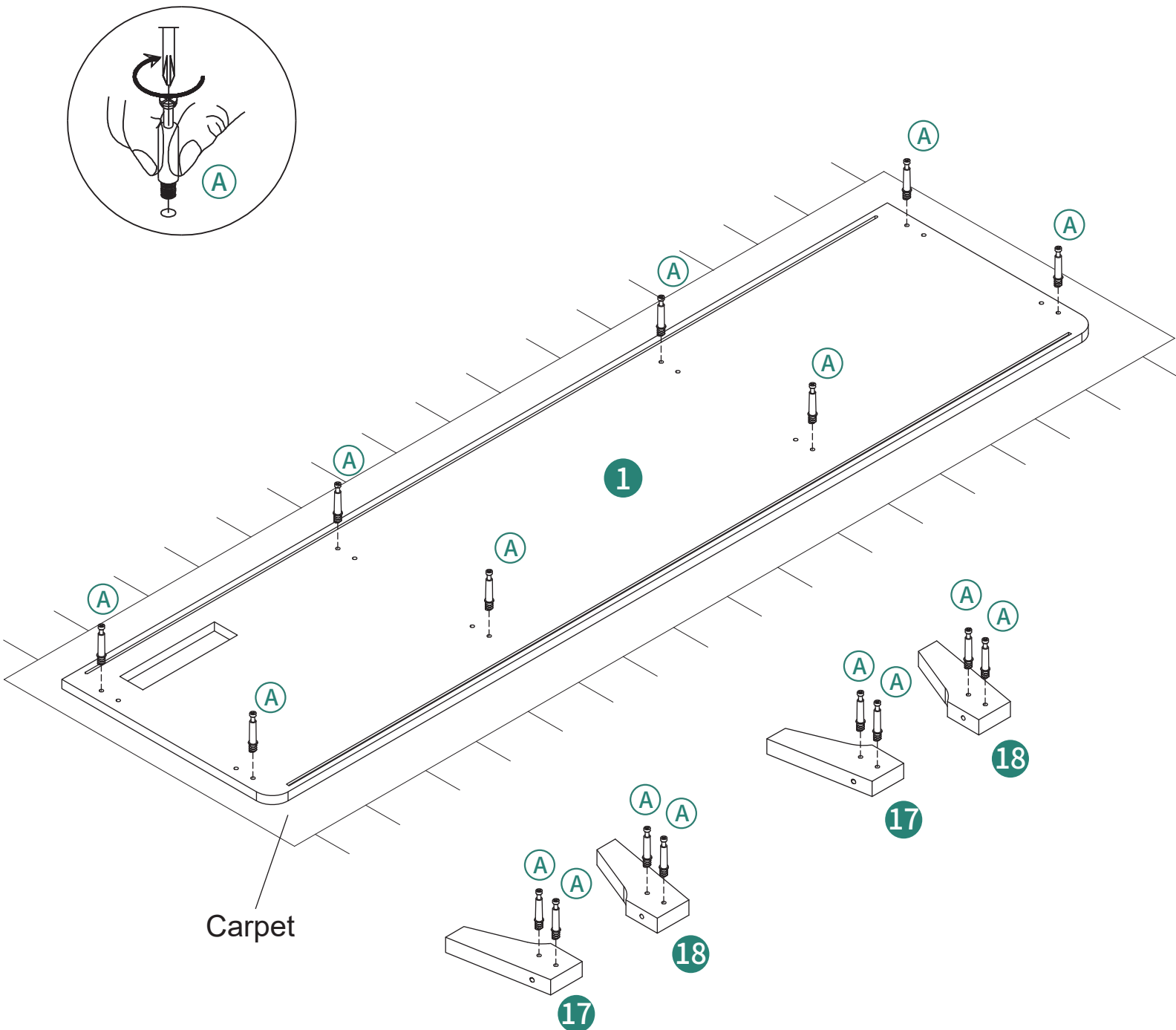
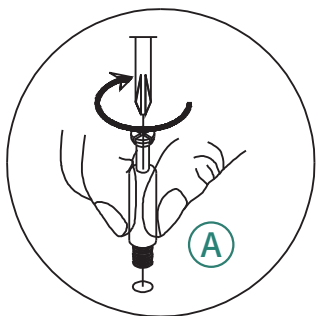
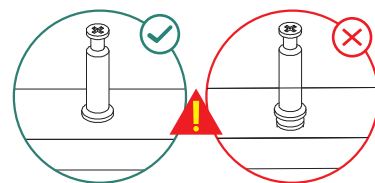

# 2

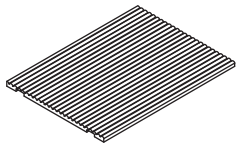

13 2pcs

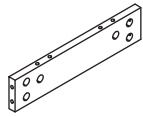

14 2pcs



B 8pcs

ST3X12mm



G 32pcs

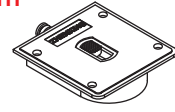

I 4pcs



J 4pcs

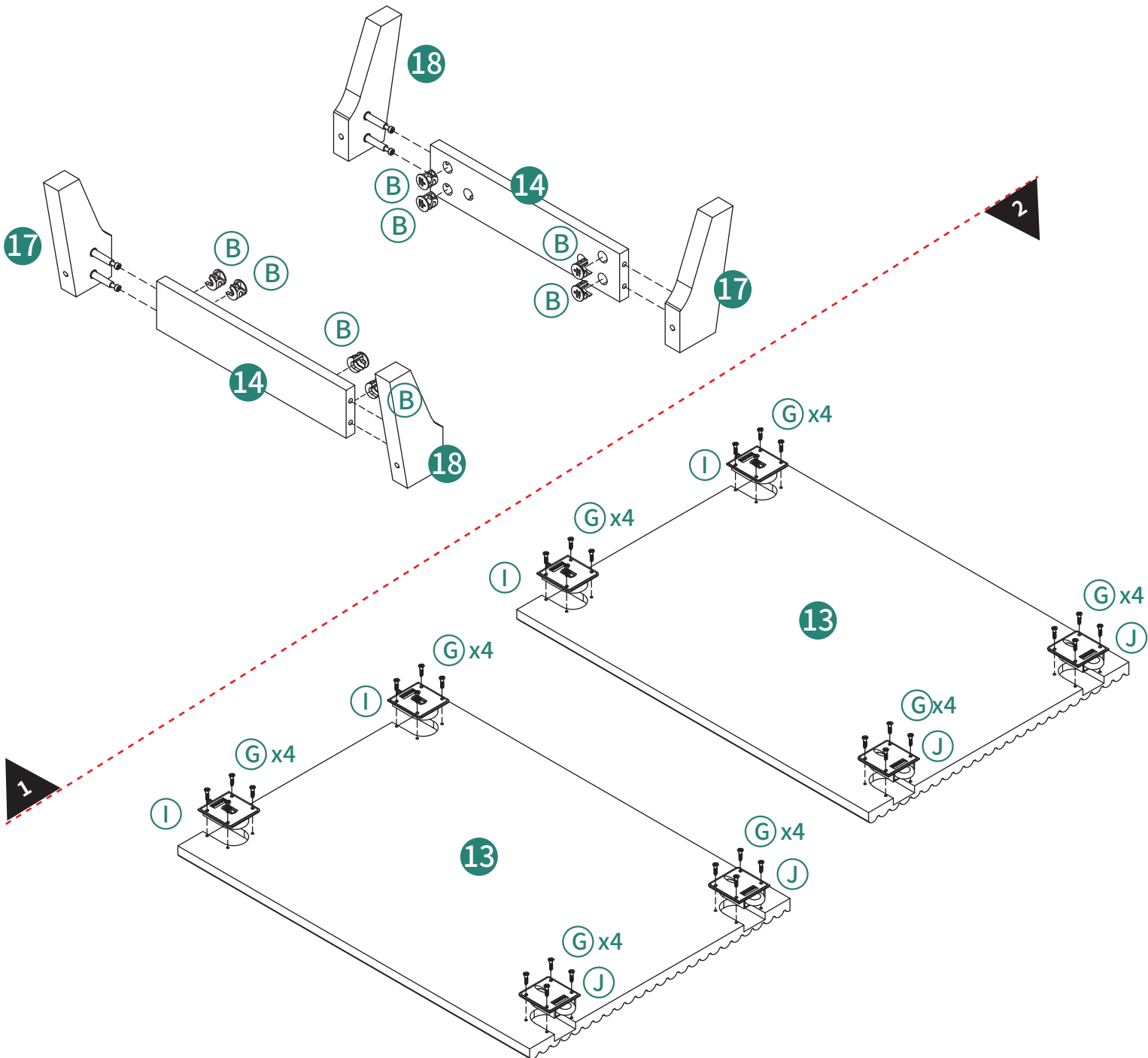

# 3

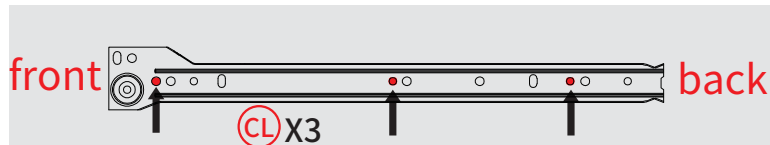
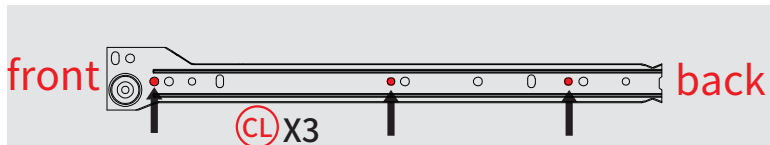
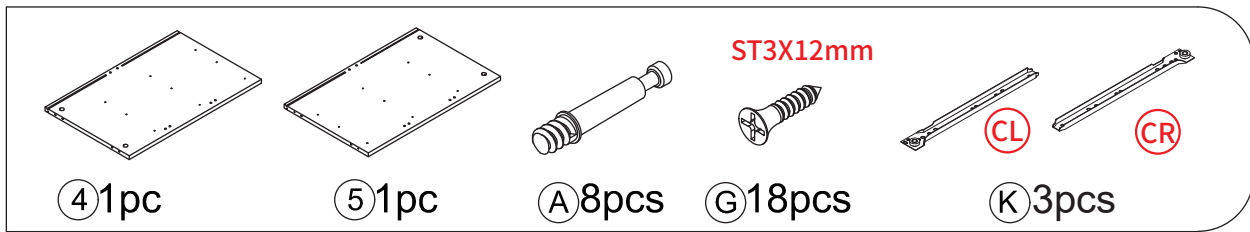

Align the screws with the center of the mounting hole of the guide rail.  
 Richten Sie die Schrauben mit der Mitte des Montagelochs der Führungsschiene aus.  
 Alignez les vis avec le centre du trou de montage du rail de guidage.  
 Allineare le viti con il centro del foro di montaggio della guida.  
 Alinee los tornillos con el centro del orificio de montaje de la guía.

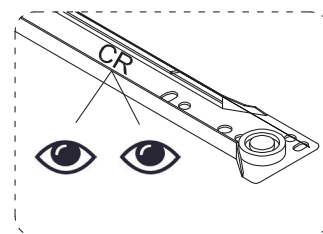
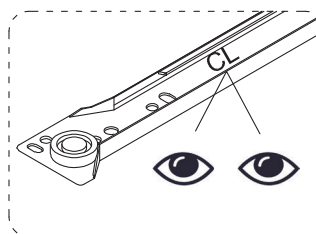
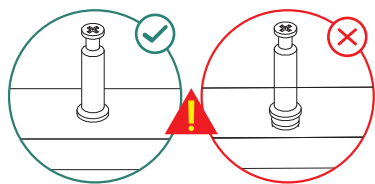
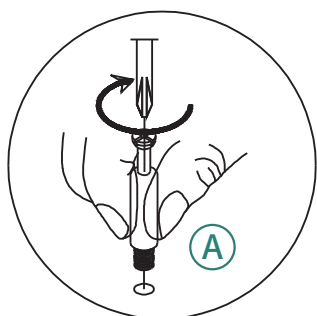
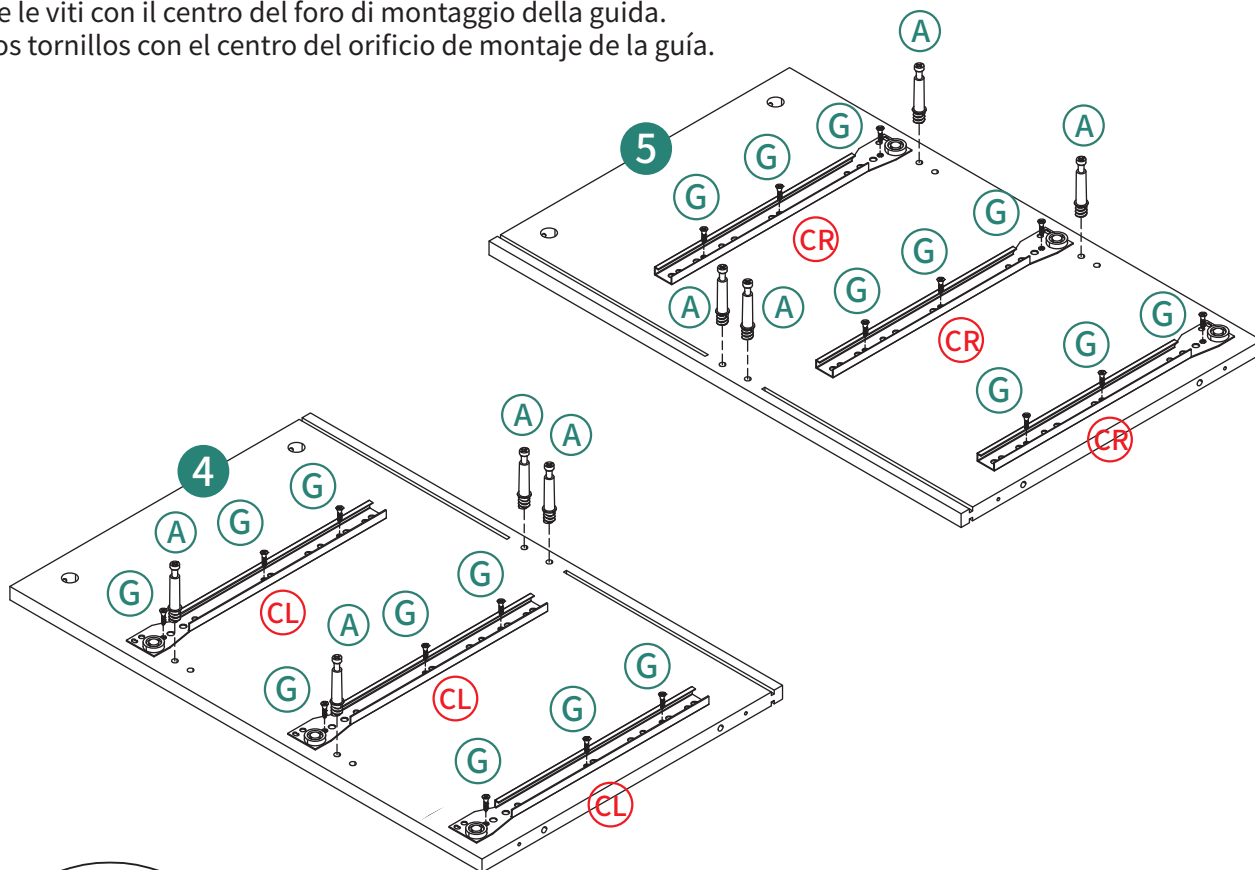

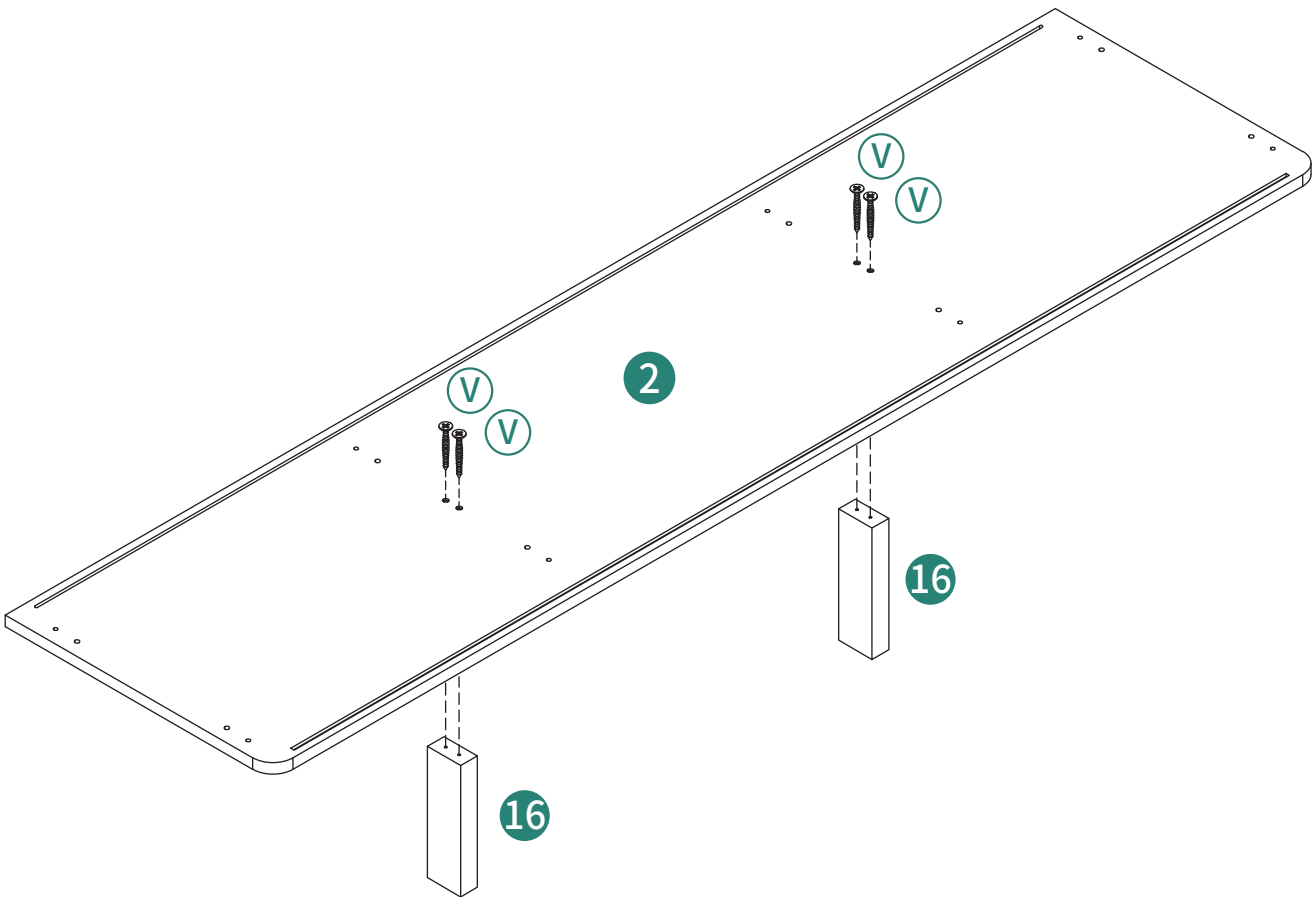
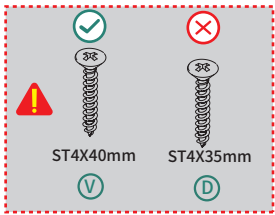
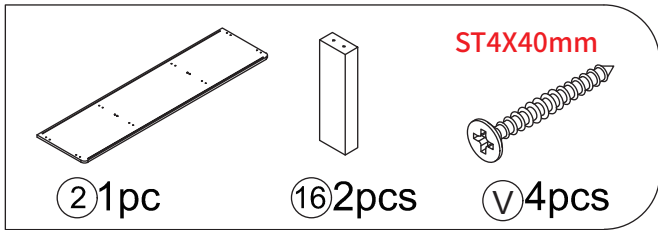

# 4

② 1pc      ①6 2pcs      ST4X40mm      ④ 4pcs

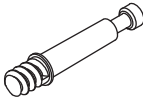

# 5

(A) 12pcs    (B) 4pcs    (C) 4pcs

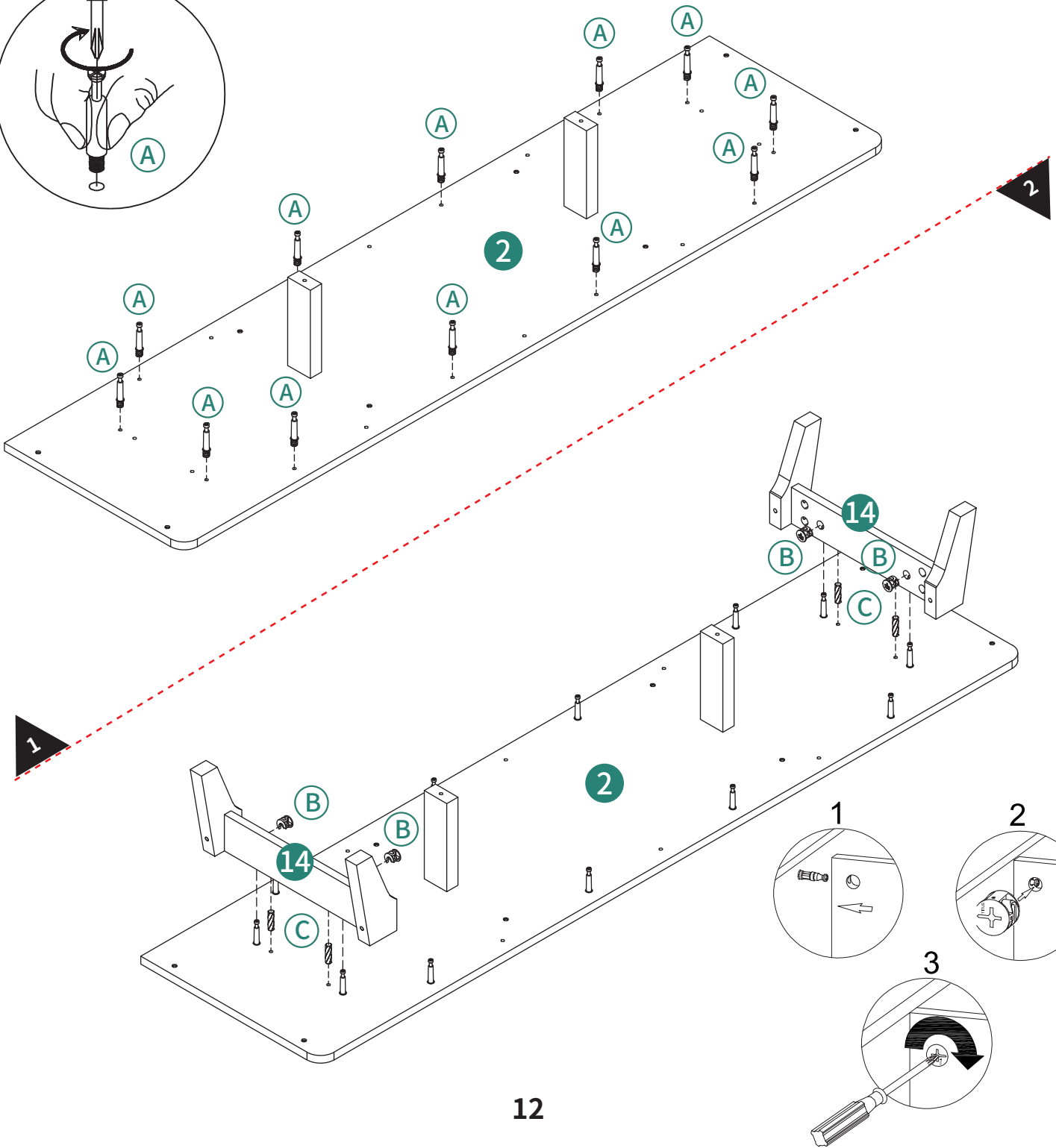
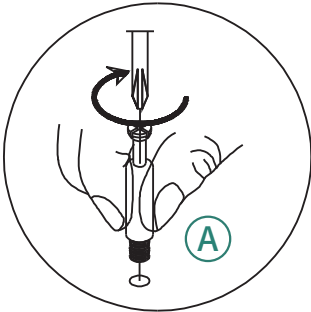
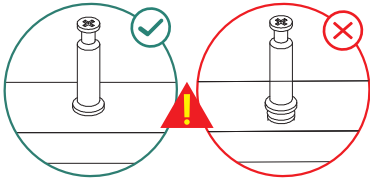

# 6

ST6X70mm



(B) 8pcs

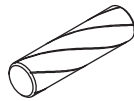

(C) 6pcs

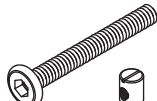

(F) 4pcs



(M) 2pcs

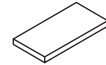

(L) 4pcs



(N) 4pcs

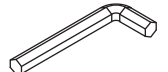

(Q) 1pc

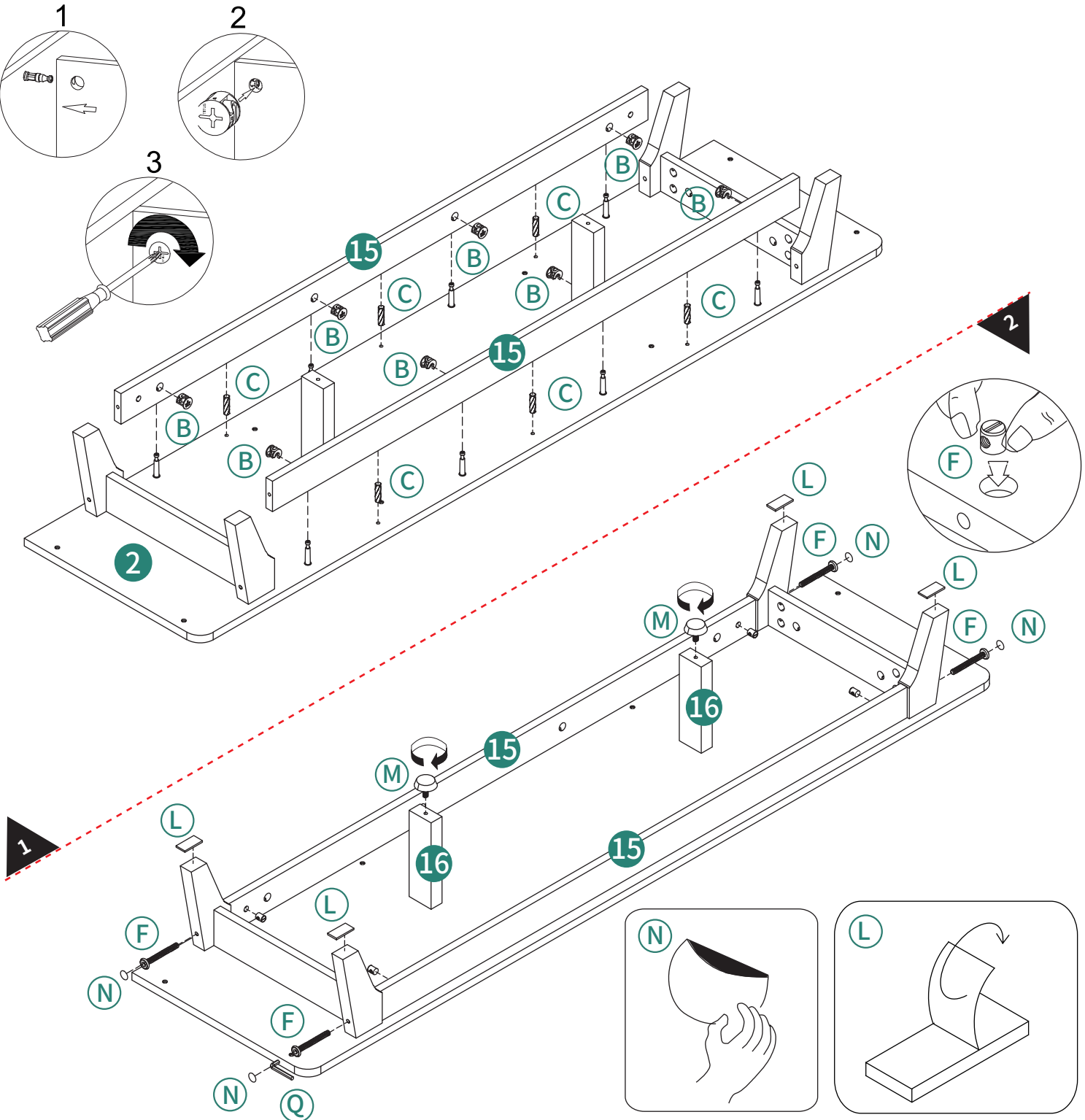
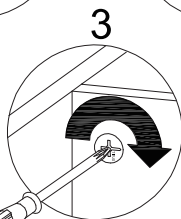
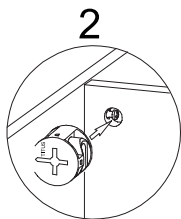
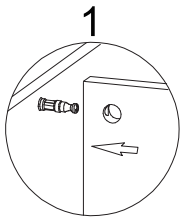

# 7

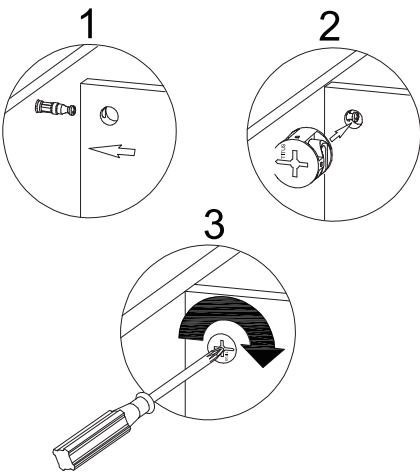
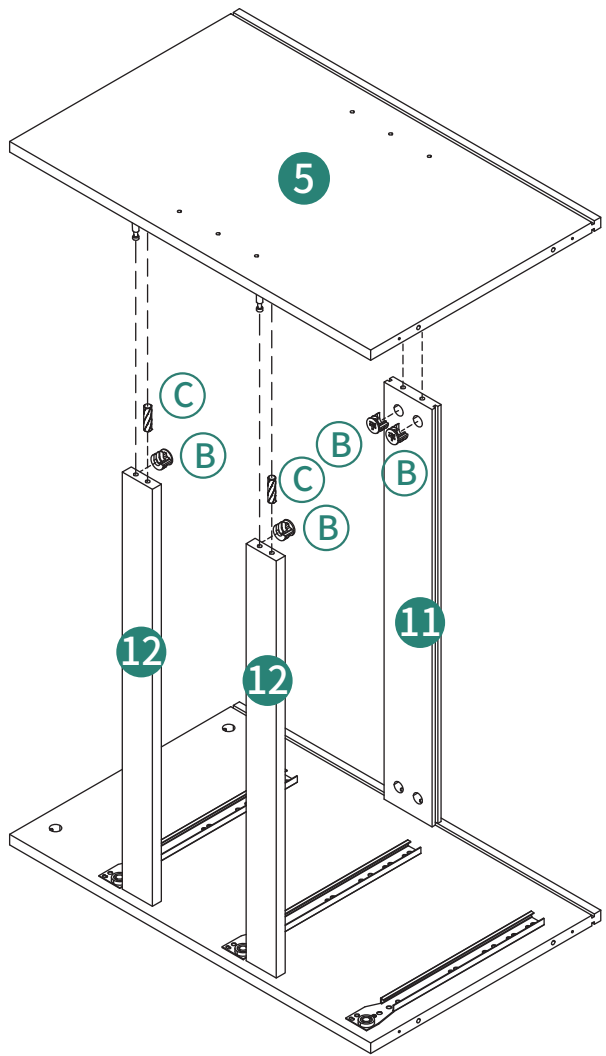
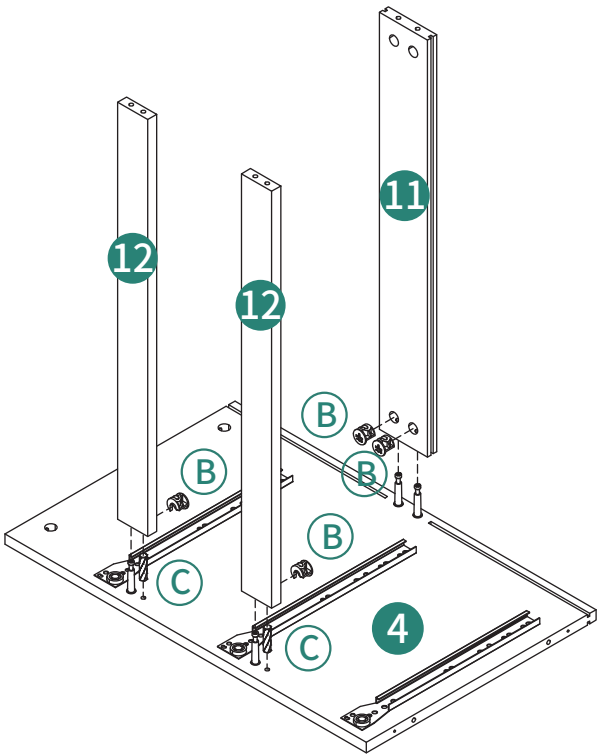

①1pc      ②2pcs      B 8pcs      C 4pcs

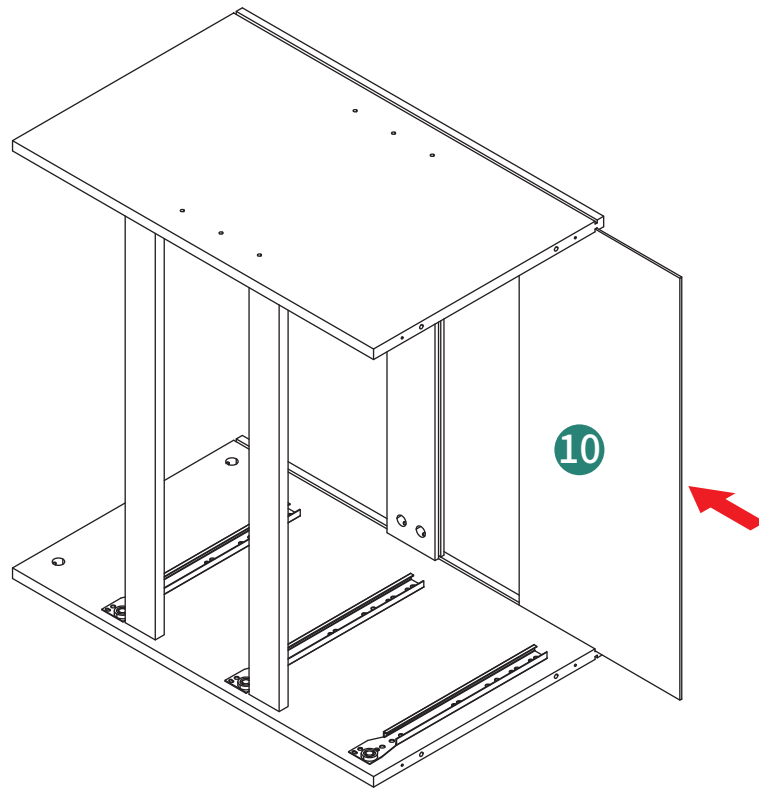
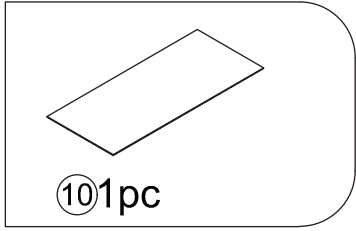

8

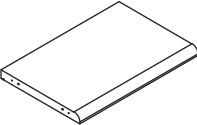
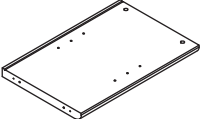
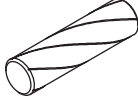

# 9

			 ST5X45mm
③1pc	⑥1pc	①C8pcs	①E8pcs

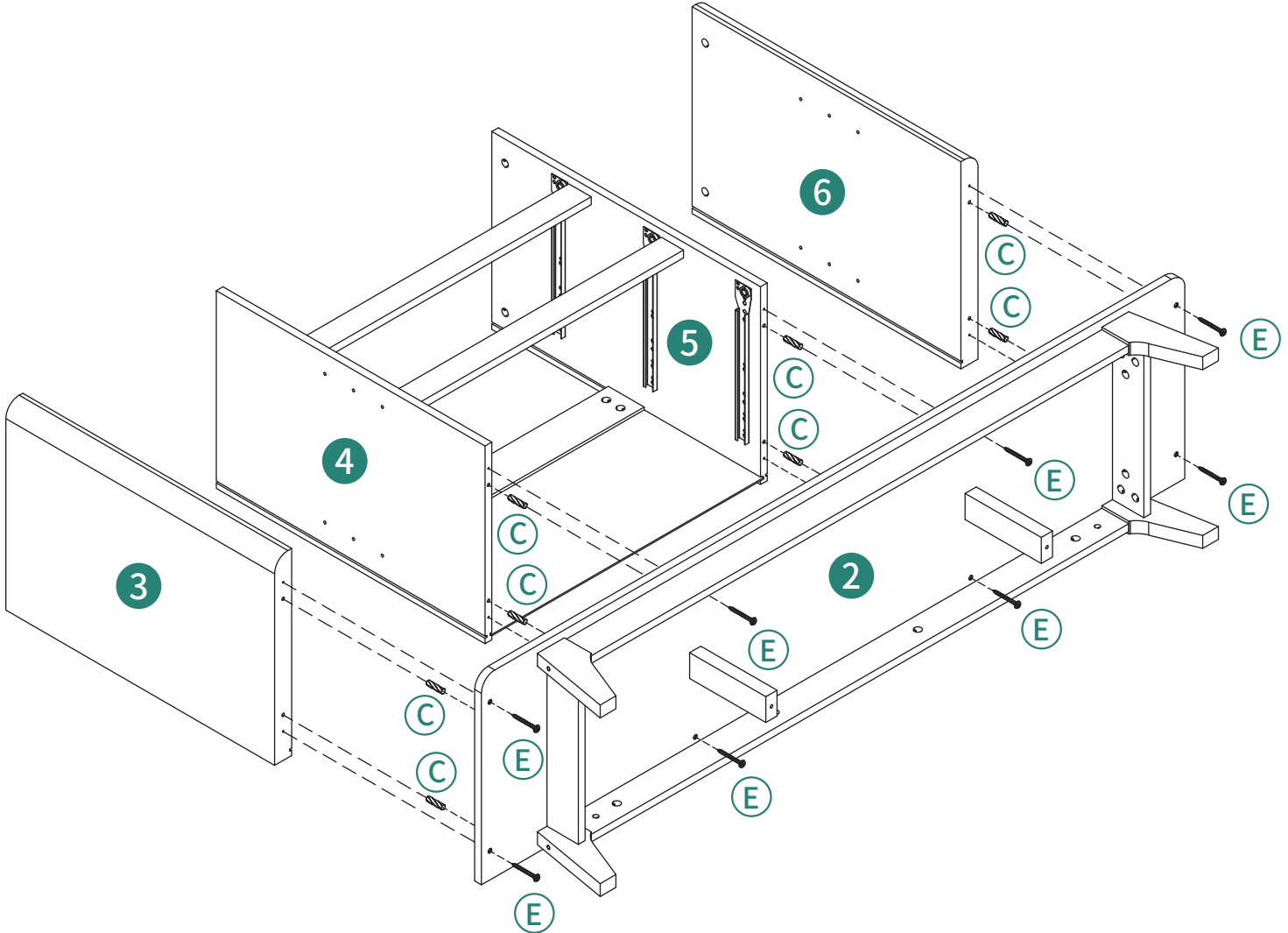

10

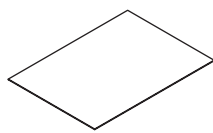

⑧1pc

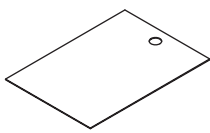

⑨1pc

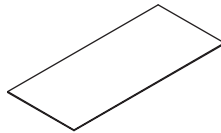

⑩1pc

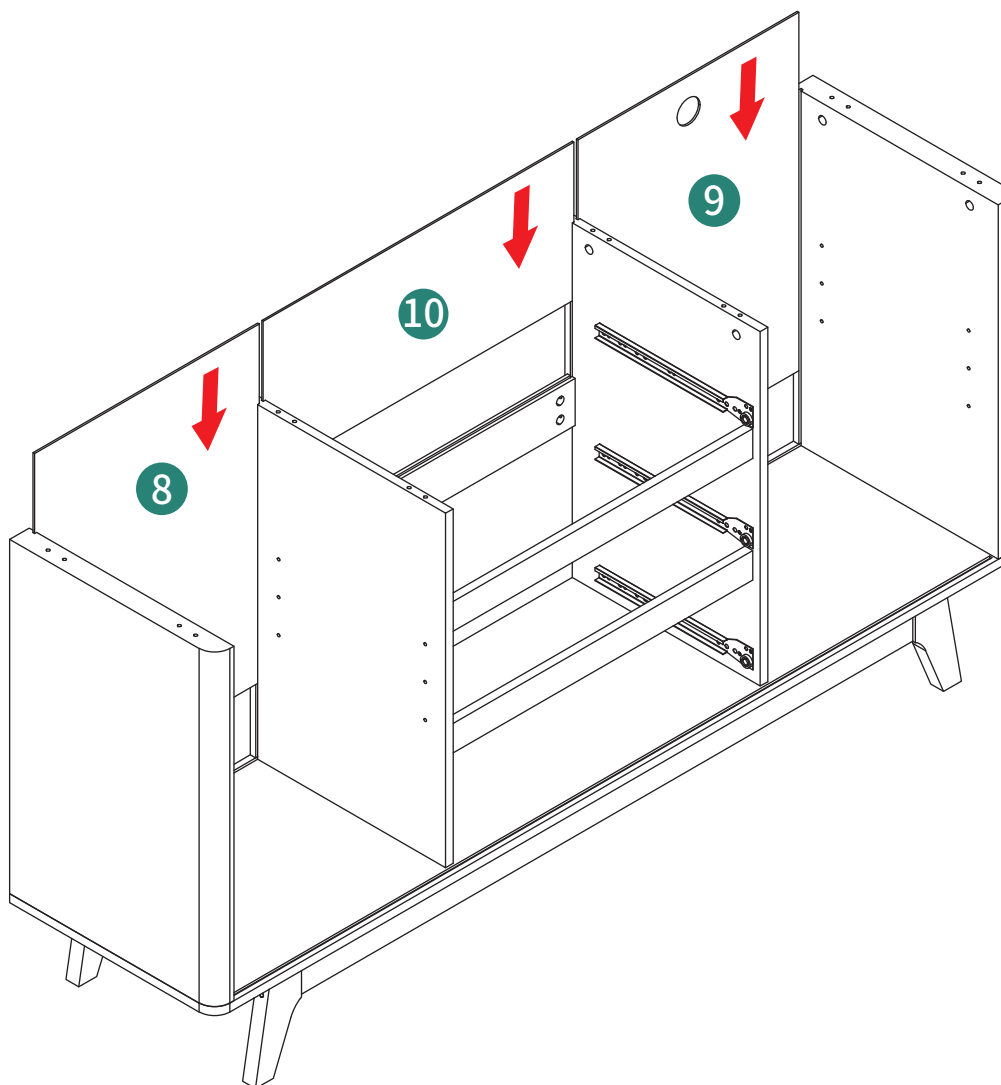

# 11

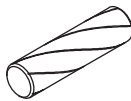
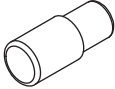
 **B** 8pcs       **C** 8pcs       **H** 8pcs

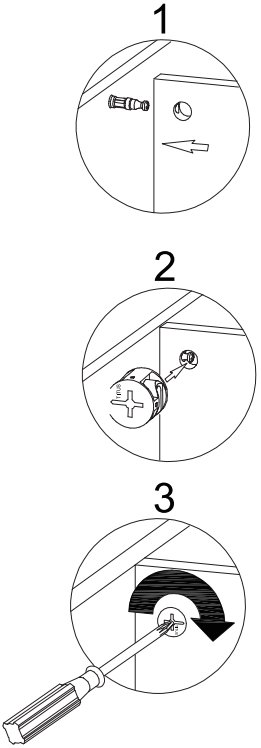
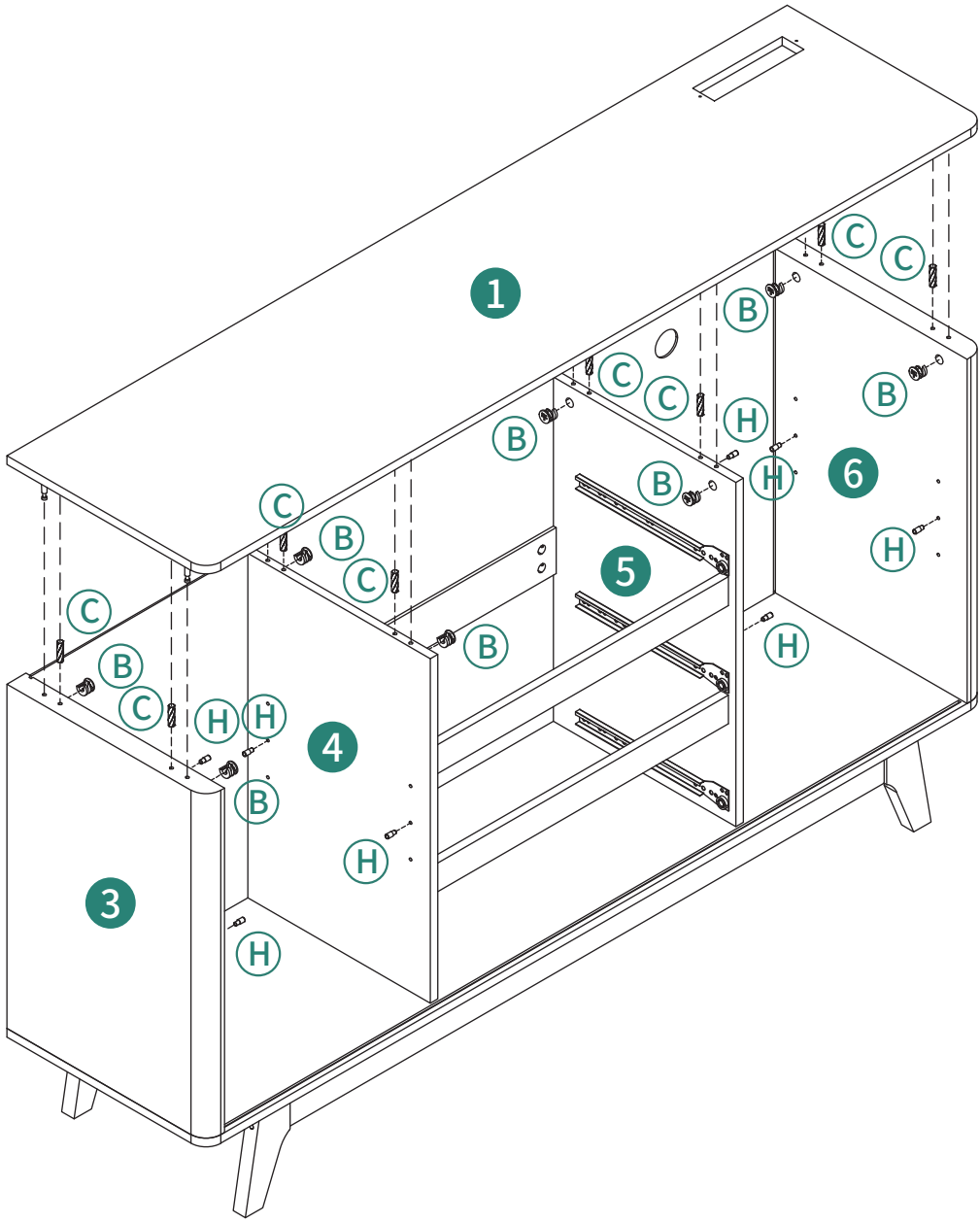

# 12

ST4X14mm

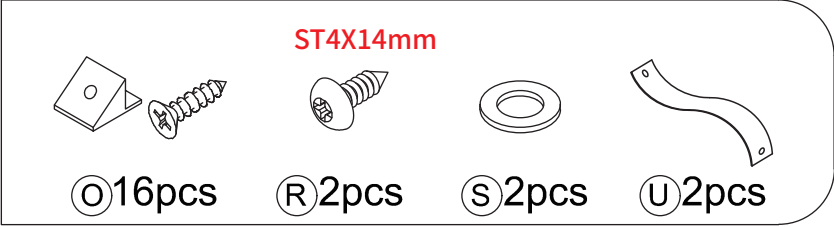

○16pcs    R2pcs    S2pcs    U2pcs

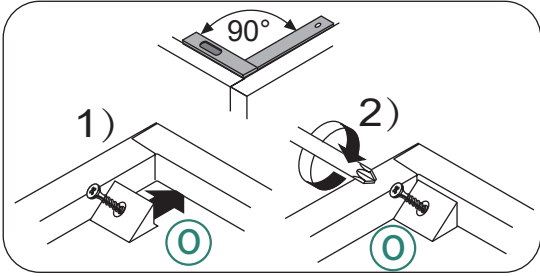
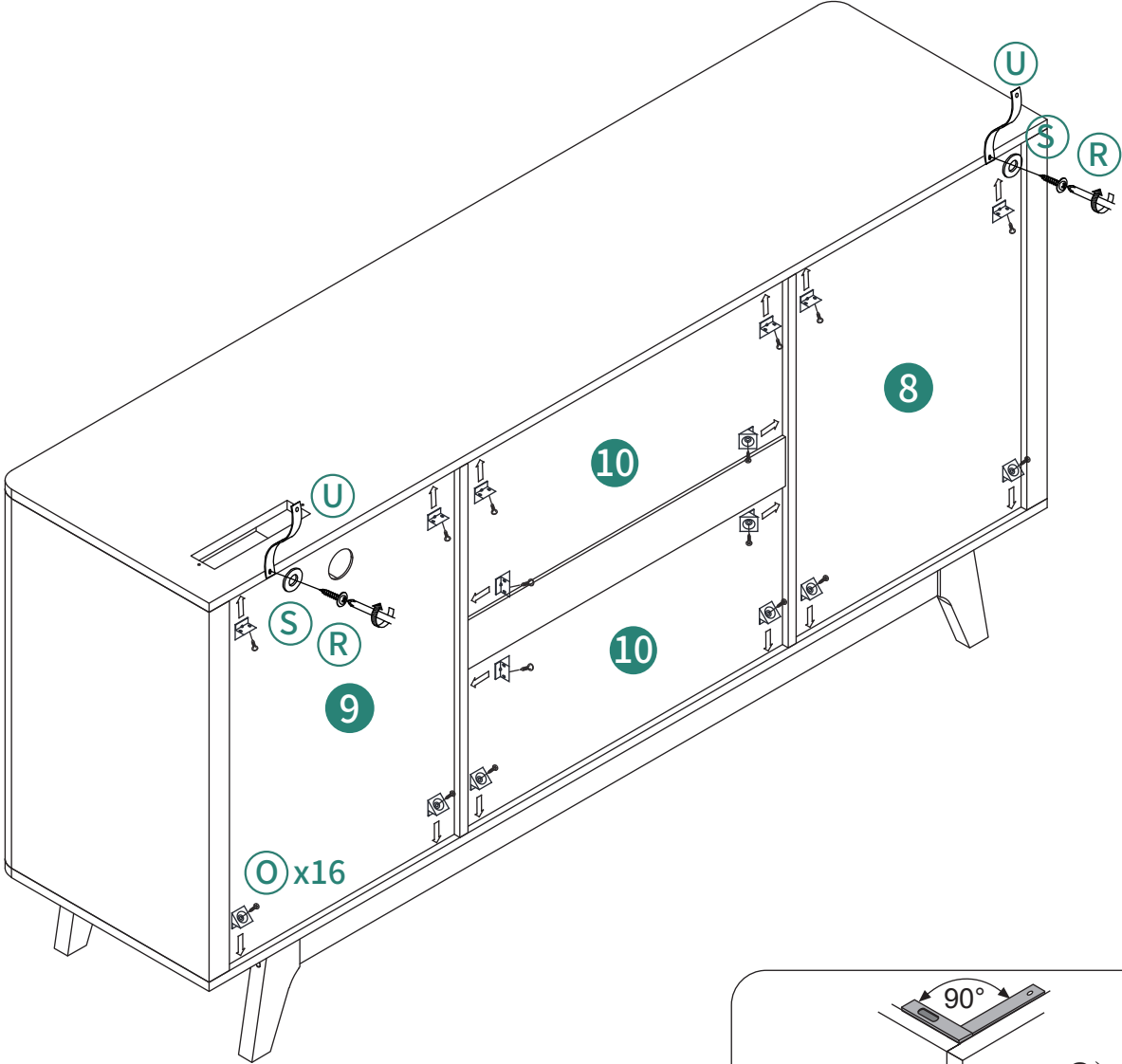

13

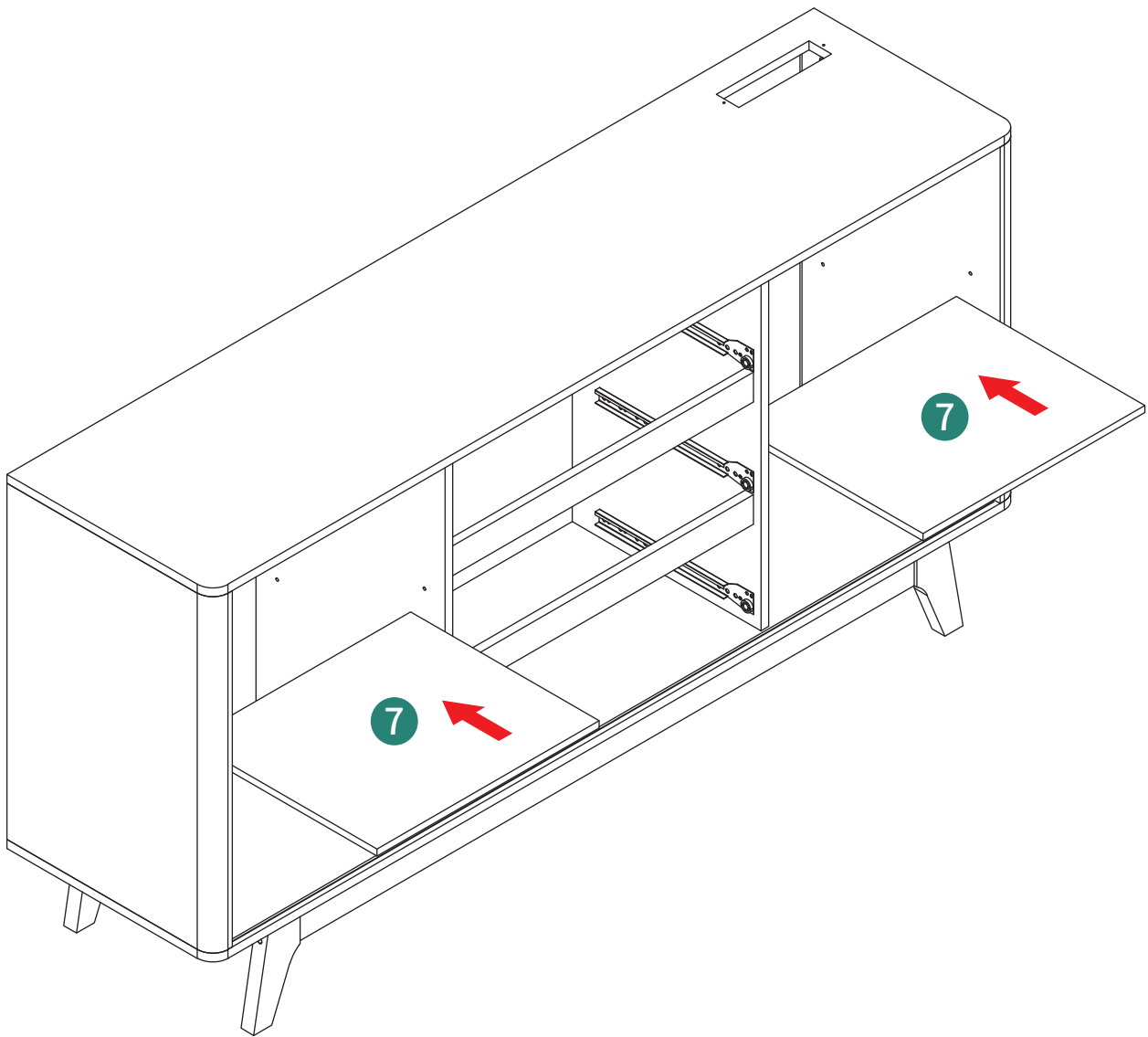
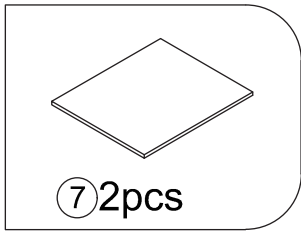

# 14

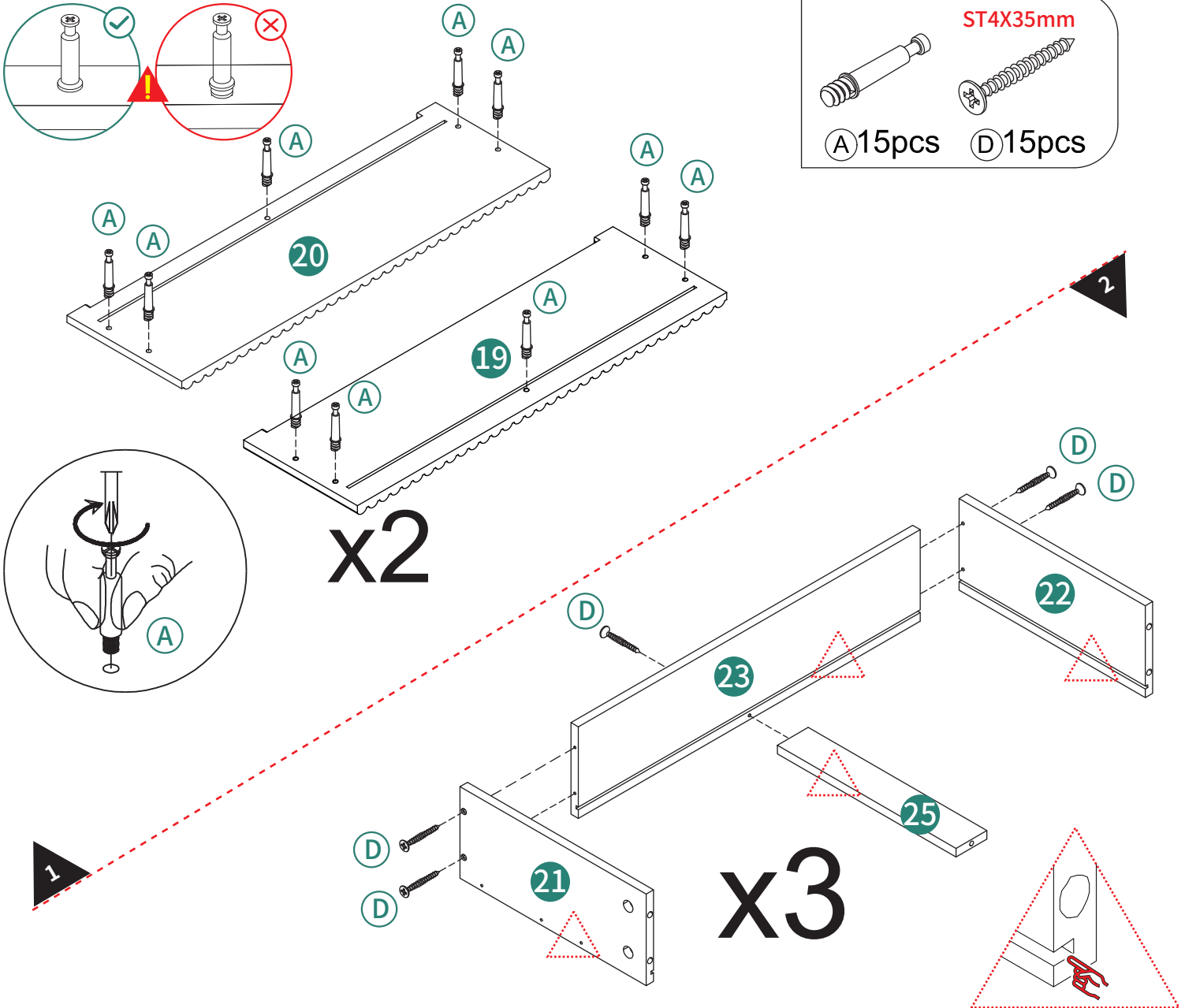
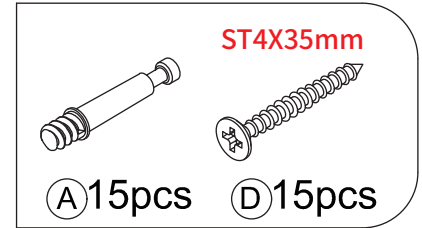
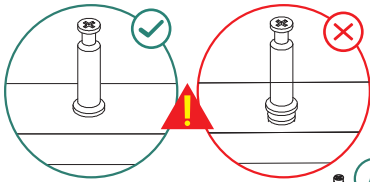
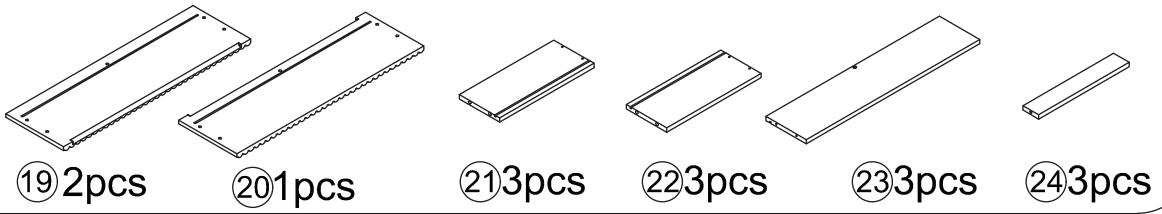

Note: Make sure the positions marked by triangles are facing the same direction.

Hinweis: Stellen Sie sicher, dass die Positionen, die durch Dreiecke markiert sind, in die gleiche Richtung zeigen.

Note : Assurez-vous que les positions marquées par des triangles sont orientées dans la même direction.

Nota: Assicurati che le posizioni contrassegnate da triangoli siano rivolte nella stessa direzione.

Nota: Asegúrate de que las posiciones marcadas con triángulos estén orientadas en la misma dirección.

**15**

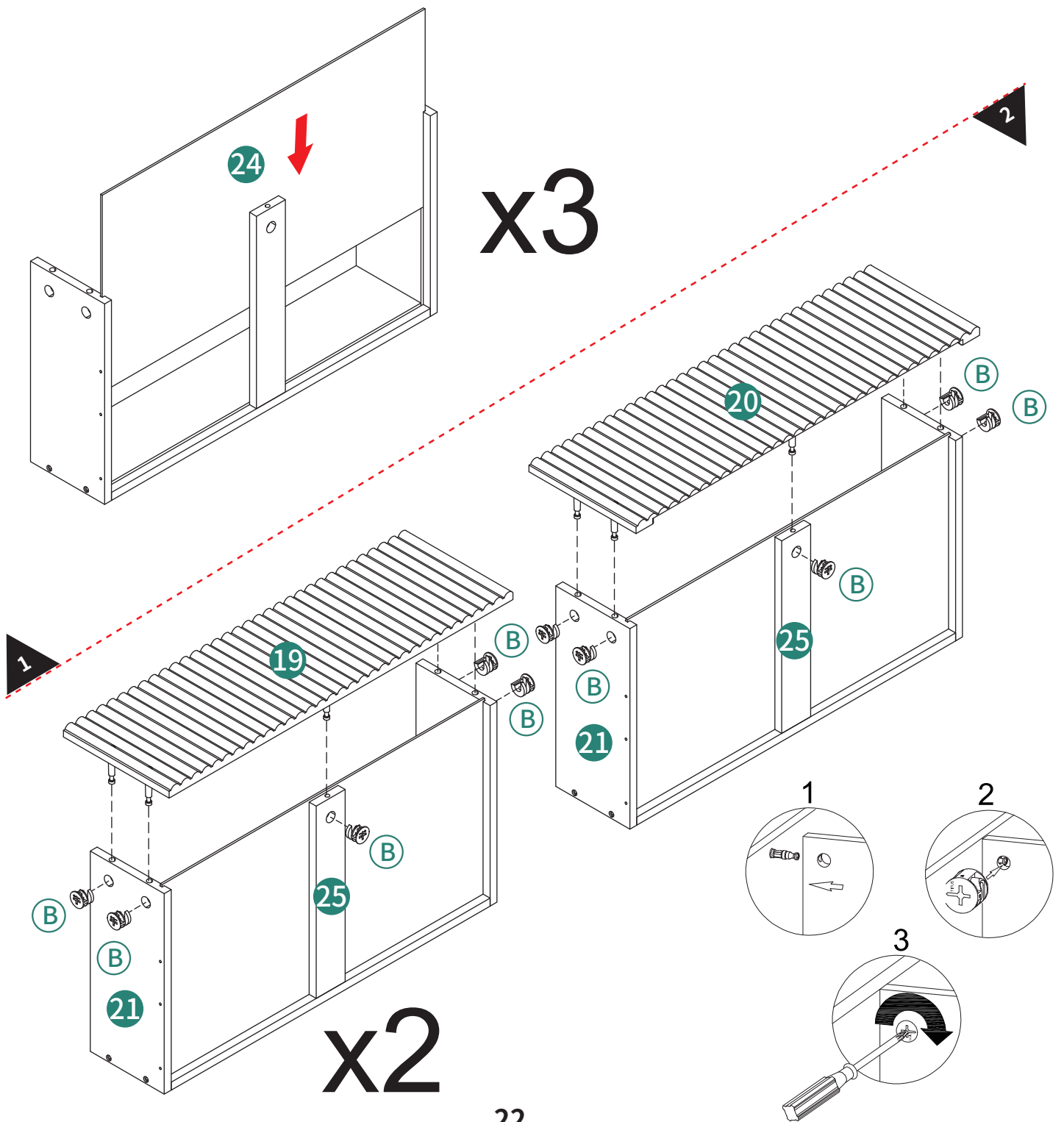
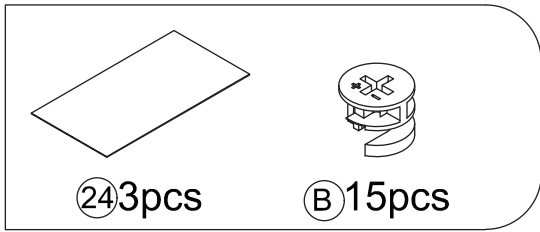

# 16

ST3X12mm

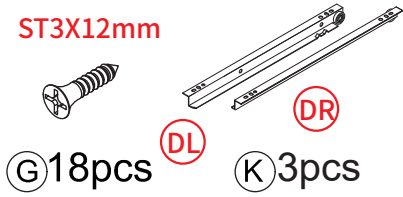

Align the screws with the center of the mounting hole of the guide rail.  
Richten Sie die Schrauben mit der Mitte des Montagelochs der Führungsschiene aus.  
Alignez les vis avec le centre du trou de montage du rail de guidage.  
Allineare le viti con il centro del foro di montaggio della guida.  
Alinee los tornillos con el centro del orificio de montaje de la guía.

x2

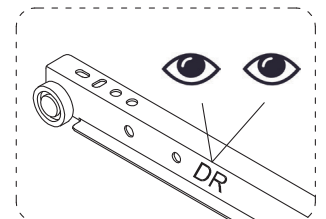
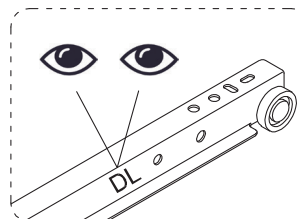
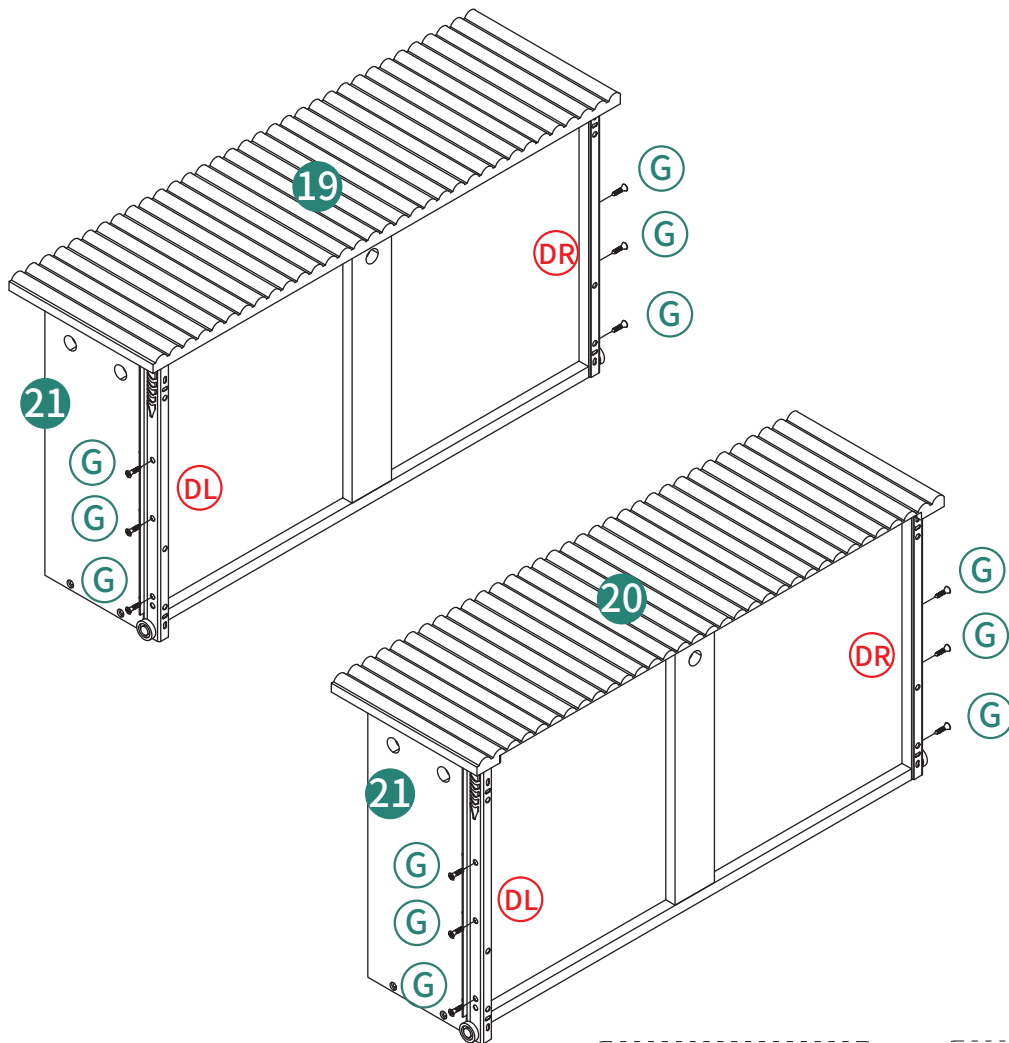

# 17

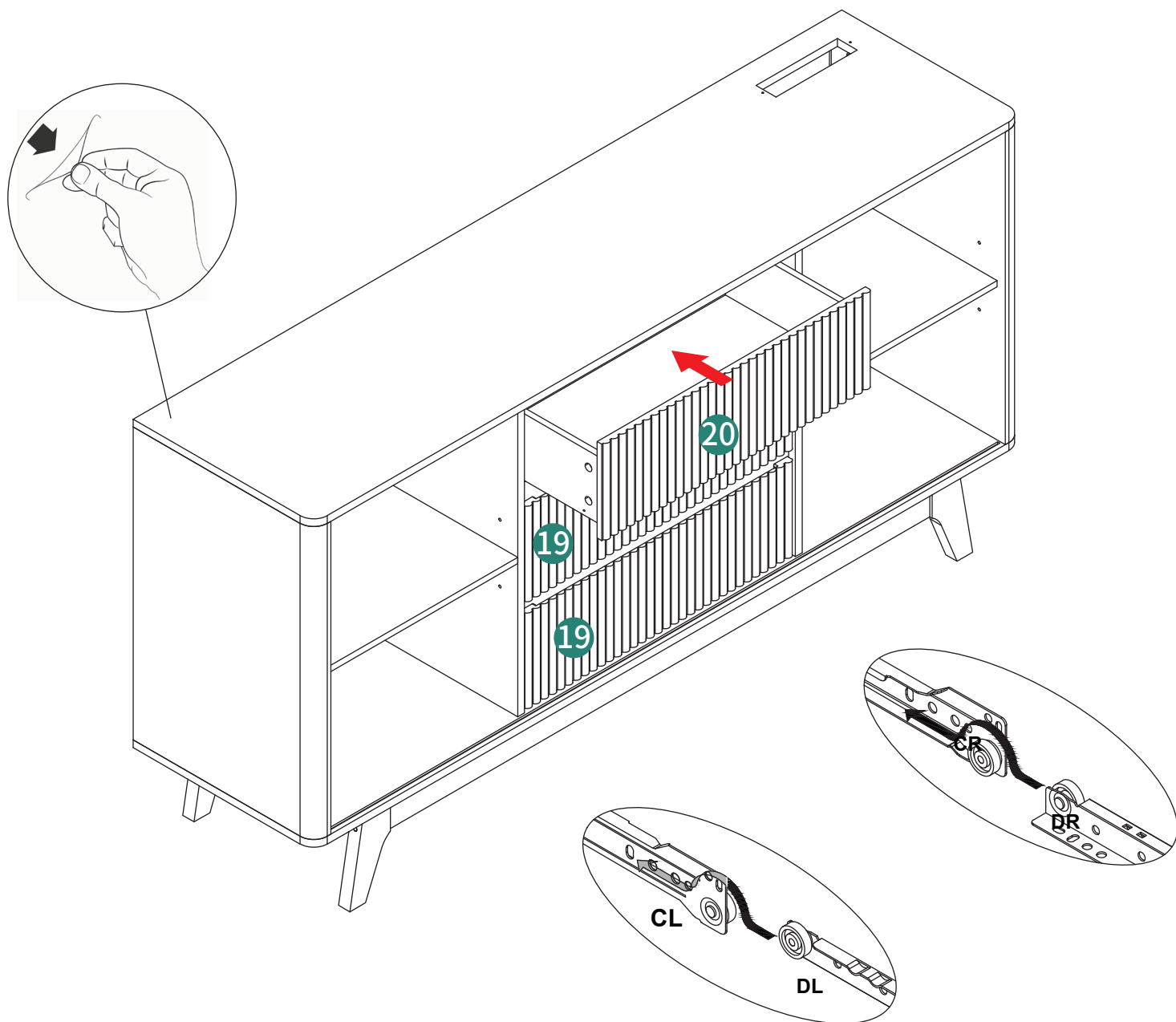

# 18

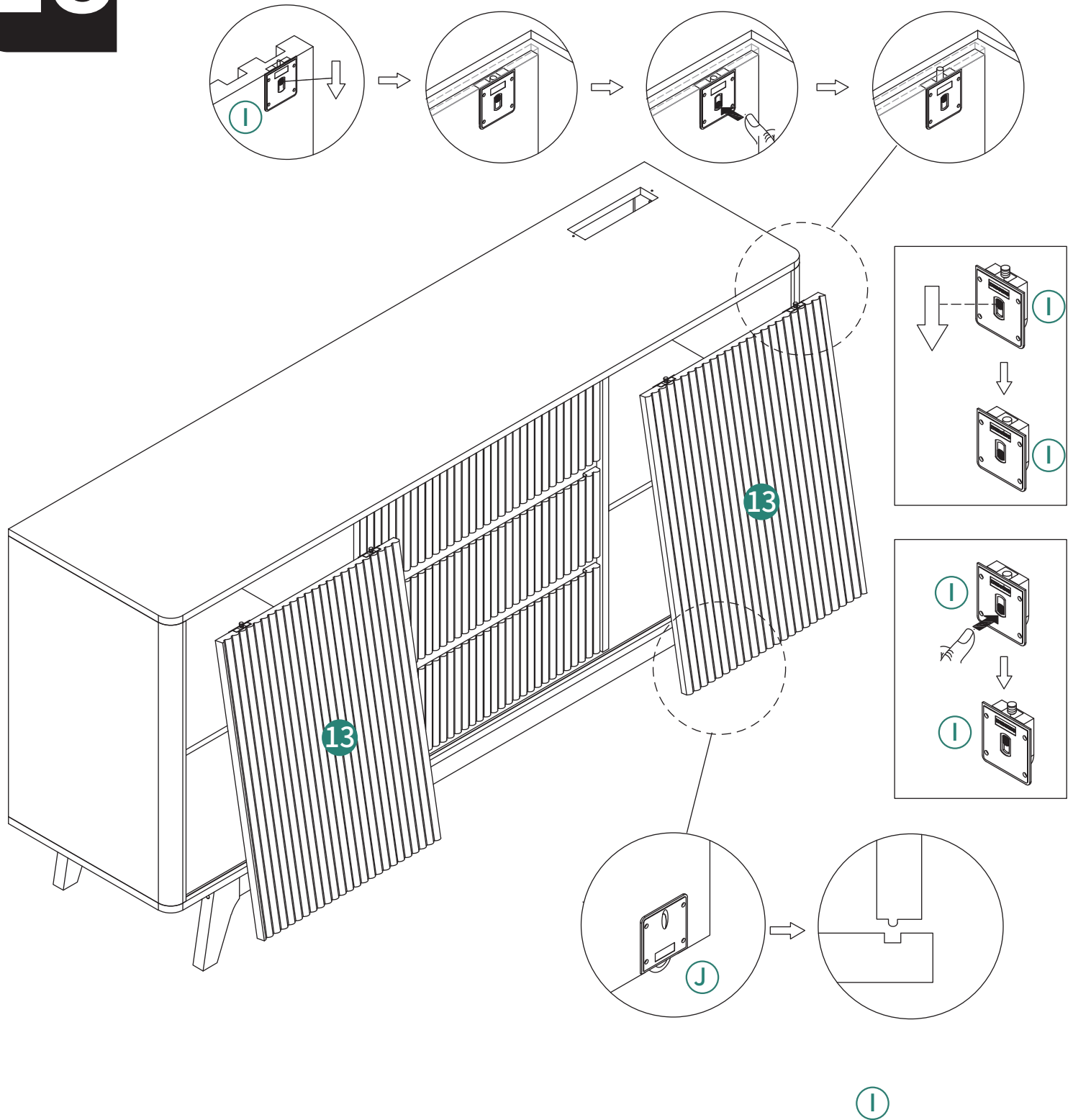

19

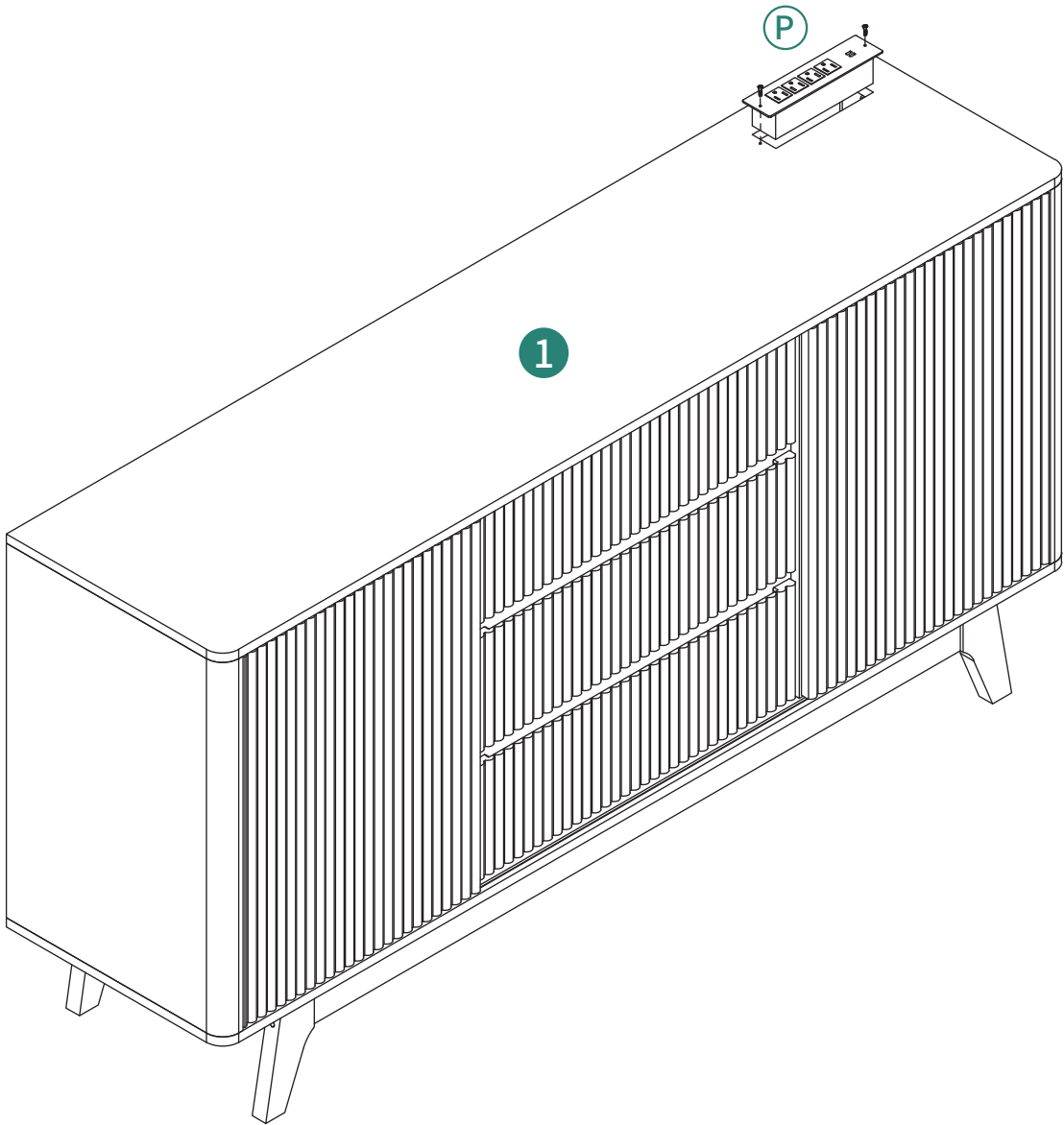
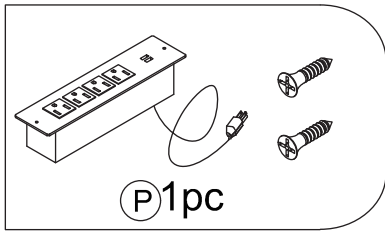

20

ST4X35mm

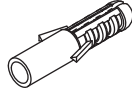
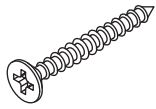

(D) 2pcs

(S) 2pcs

(T) 2pcs

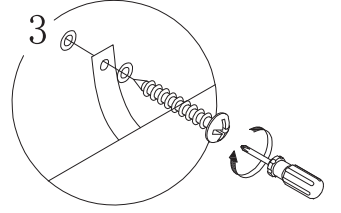
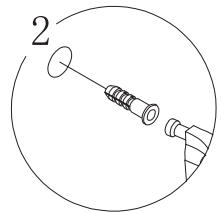
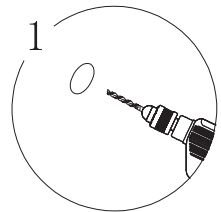
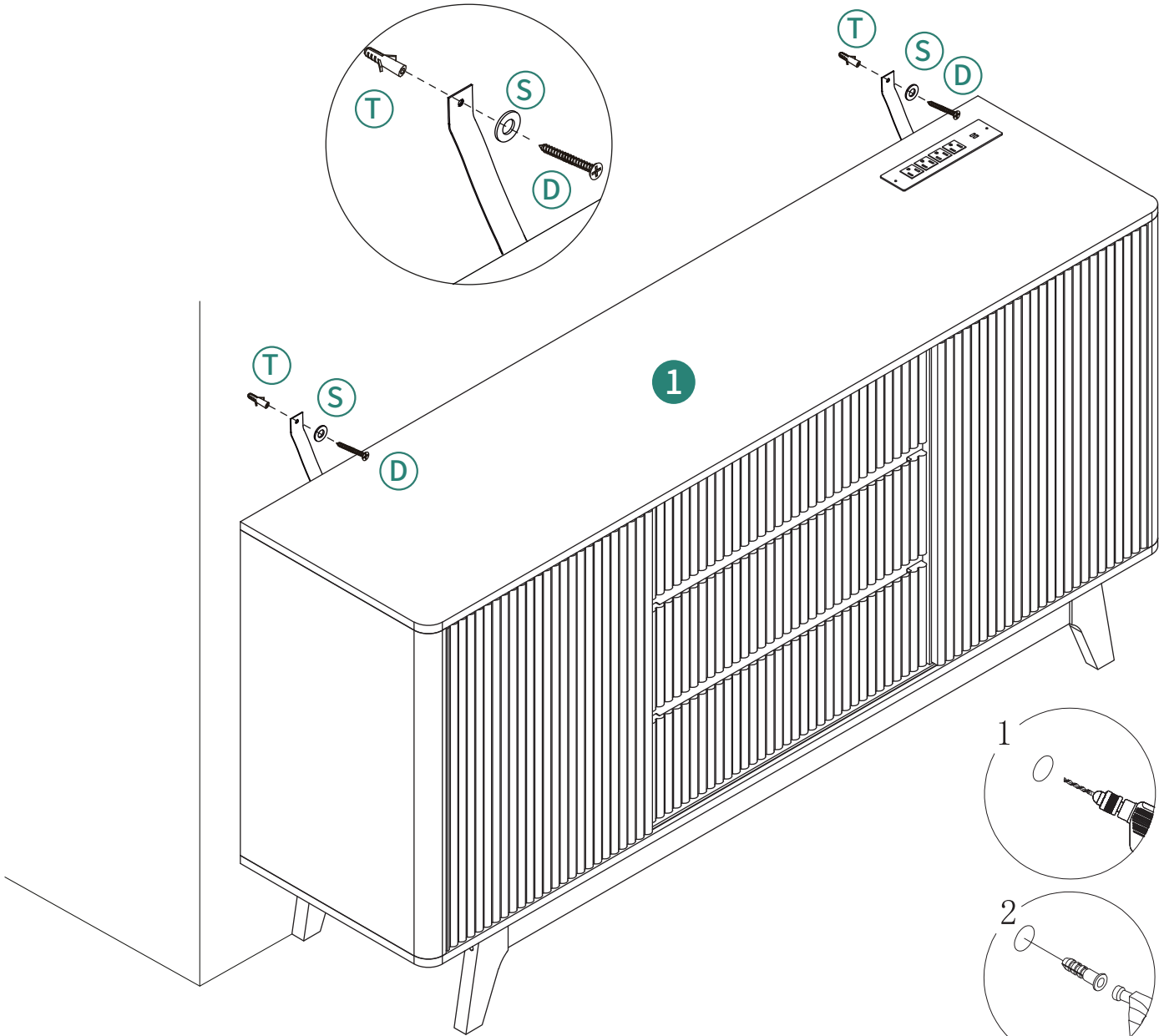
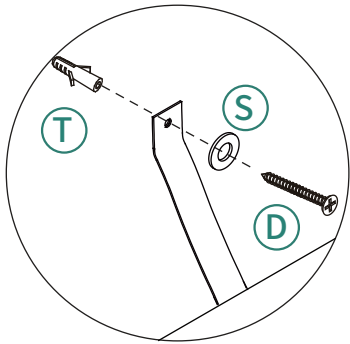

21

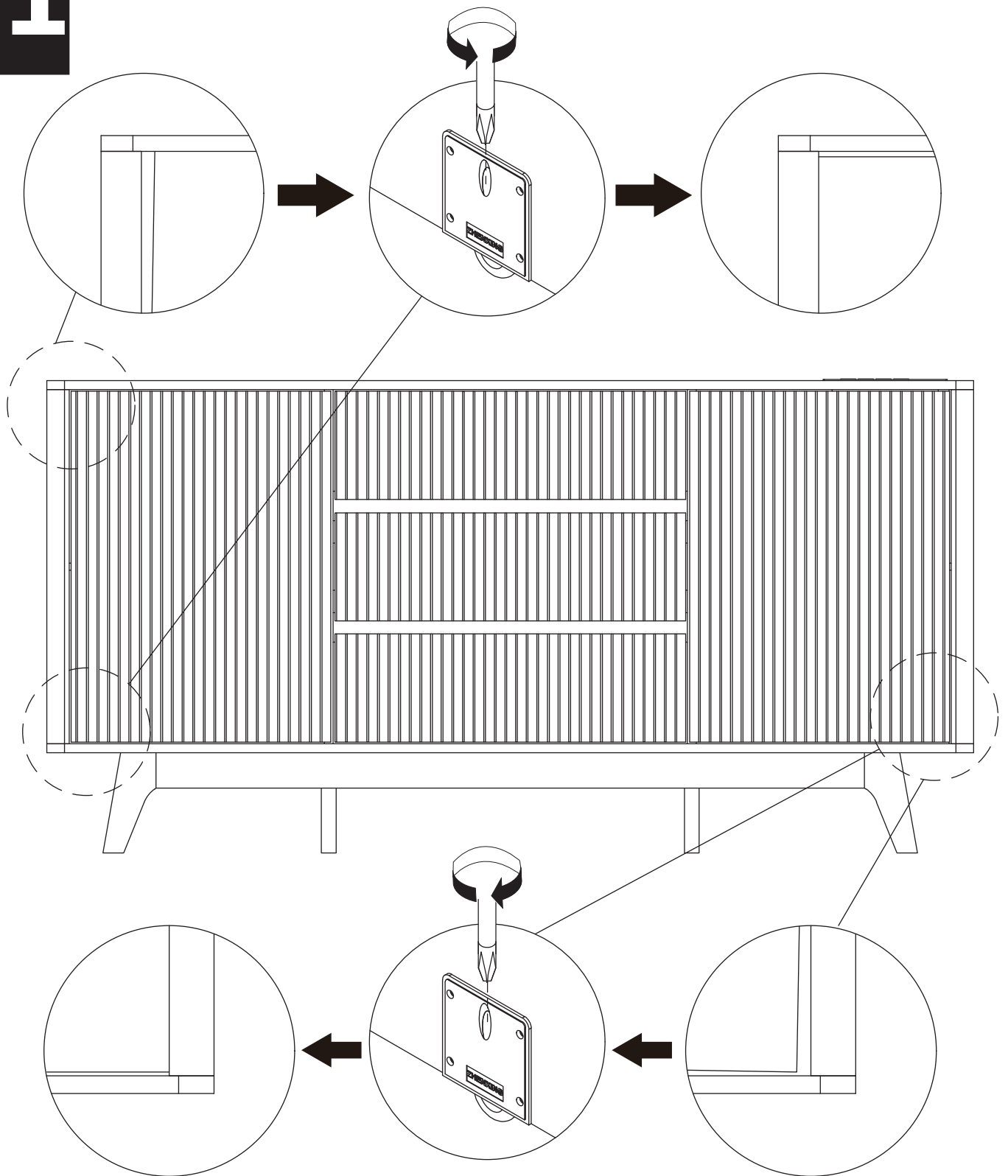

# HELP CENTER



Inquiry



Assembly issue



Missing parts



Returns&Refunds

If you encounter any difficulties during assembly, please contact us.[support@Yanosaku.com](mailto:support@Yanosaku.com)  
Wenn Sie während der Montage auf Schwierigkeiten stoßen, kontaktieren Sie uns bitte.[support@Yanosaku.com](mailto:support@Yanosaku.com)

Si vous rencontrez des difficultés lors du montage, veuillez nous contacter.[support@Yanosaku.com](mailto:support@Yanosaku.com)

Se incontri difficoltà durante il montaggio, ti preghiamo di contattarci.[support@Yanosaku.com](mailto:support@Yanosaku.com)  
Si encuentras alguna dificultad durante el ensamblaje, por favor contáctanos.[support@Yanosaku.com](mailto:support@Yanosaku.com)

# DISCLAIMER

Manufacturer and seller expressly disclaim any and all liability for personal injury, property damage or loss, whether direct, indirect, or incidental, resulting from the incorrect attachment, improper use, inadequate maintenance, unapproved modification, or neglect of this product.

Der Hersteller und Verkäufer lehnen ausdrücklich jegliche Haftung für Personenschäden, Sachschäden oder Verluste ab, egal ob direkt, indirekt oder zufällig, die durch falsche Anbringung, unsachgemäßen Gebrauch, unzureichende Wartung, nicht genehmigte Änderungen oder Vernachlässigung dieses Produkts entstehen.

El fabricante y vendedor renuncian expresamente a toda responsabilidad por lesiones personales, daños materiales o pérdidas, ya sean directos, indirectos o incidentales, derivados de la incorrecta colocación, uso inadecuado, mantenimiento insuficiente, modificación no aprobada o negligencia de este producto.

Il produttore e il venditore declinano espressamente ogni responsabilità per lesioni personali, danni materiali o perdite, dirette, indirette o incidentali, derivanti dall'errato fissaggio, uso improprio, manutenzione inadeguata, modifica non autorizzata o negligenza di questo prodotto.

Le fabricant et le vendeur déclinent expressément toute responsabilité en cas de blessures corporelles, de dommages matériels ou de pertes, qu'ils soient directs, indirects ou accessoires, résultant de la fixation incorrecte, de l'utilisation inappropriée, de l'entretien insuffisant, de la modification non approuvée ou de la négligence de ce produit.