

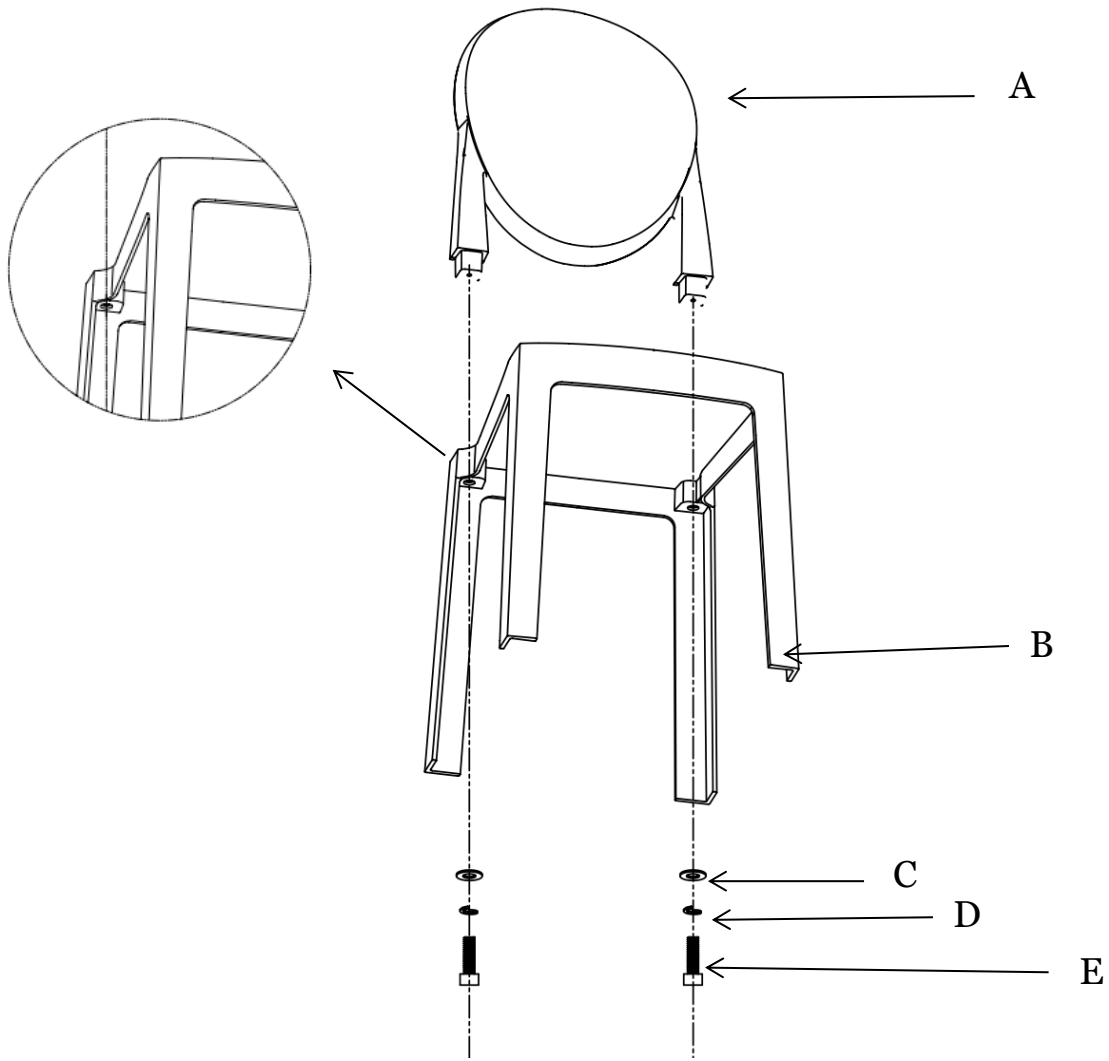





Assembly Instructions



					
A. 1PC	B. 1PC	C. 2PCS	D. 2PCS	E. 2PCS	F. 1PC