

### Features

- VibrAcoustic technology emits sound waves and offers a surround sound experience.
- Six transducers and a control amplifier with 25' (7.6 m) of wiring.
- User-friendly high-resolution color touch screen in polished chrome.
- Bask™ heated surface with three temperature settings.
- Molded lumbar support for comfort.
- Reversible drain.
- 66 " (1676 mm) x 42 " (1067 mm) x 22 " (559 mm)

### Material

- Acrylic

### Installation

- Drop-in installation.



### Codes/Standards











CSA B45.5/IAPMO Z124  
ASTM E162  
ASTM E662  
UL 1795  
CSA C22.2 No. 218.2

### KOHLER® One-Year Limited Warranty

See website for detailed warranty information.

### Available Color/Finishes

*Color tiles intended for reference only.*

Color	Code	Description
	0	White
	96	Biscuit
	47	Almond
	NY	Dune
	95	Ice™ Grey
	G9	Sandbar
	33	Mexican Sand™
	K4	Cashmere
	58	Thunder™ Grey
	7	Black Black™

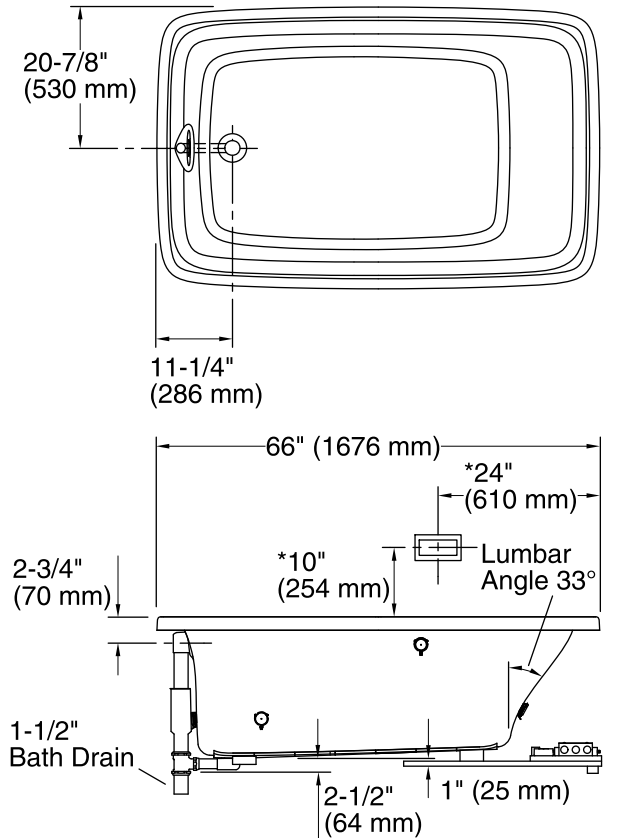

No change in measurements if connected with drain illustrated. (K-7161-AF)

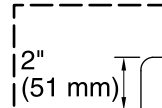

**Drop-in Rim Detail**

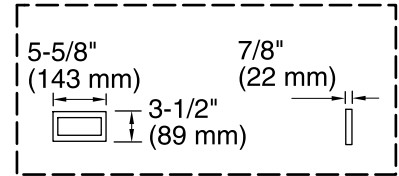

**User Interface**

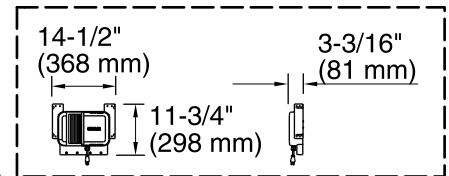

**Control Amplifier**

Access Panel  
30" (762 mm) W x  
15" (381 mm) H Min

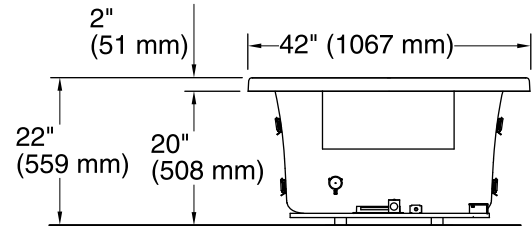

**\*Recommended User Interface Location**

### Required Electrical Service

One dedicated circuit required, protected with Class A Ground-Fault Circuit-Interrupter (GFCI) or Residual Current Device (RCD).

Amplifier, Heater: 120 V, 15 A, 50/60 Hz

### Technical Information

All product dimensions are nominal.

Installation:	Drop-in
Drain location:	Reversible
Basin area, bottom:	46" x 30" (1168 mm x 762 mm)
Basin area, top:	57" x 34" (1448 mm x 864 mm)
Weight:	96 lbs (43.5 kg)
Minimum floor load:	47.6 lbs/ft <sup>2</sup> (232.4 kg/m <sup>2</sup> )
Water depth:	16" (406 mm)
Water capacity:	95 gal (359.6 L)
Template:	Drop-in, 1043292-7, not required, not included
Electrical rating:	Amplifier: 120 V, 50/60 Hz, 15 W Heater: 120 V, 1.1 A, 60 Hz, 65 W

### Notes

Install this product according to the installation guide. Ensure that the interface, amplifier, and transducers are functional before completing the installation.

Control amplifier fits 16" (406 mm) center studs. 25' (7.6 m) cables are included.

Locate the bath within 24" (610 mm) of a GFCI-protected 120 V, 15 A grounded electrical outlet. A second grounded outlet within the wall framing must be within 24" (610 mm) of the planned control amplifier. One electrical service may be used for the entire bath and related electrical components.