

OWNER'S MANUAL

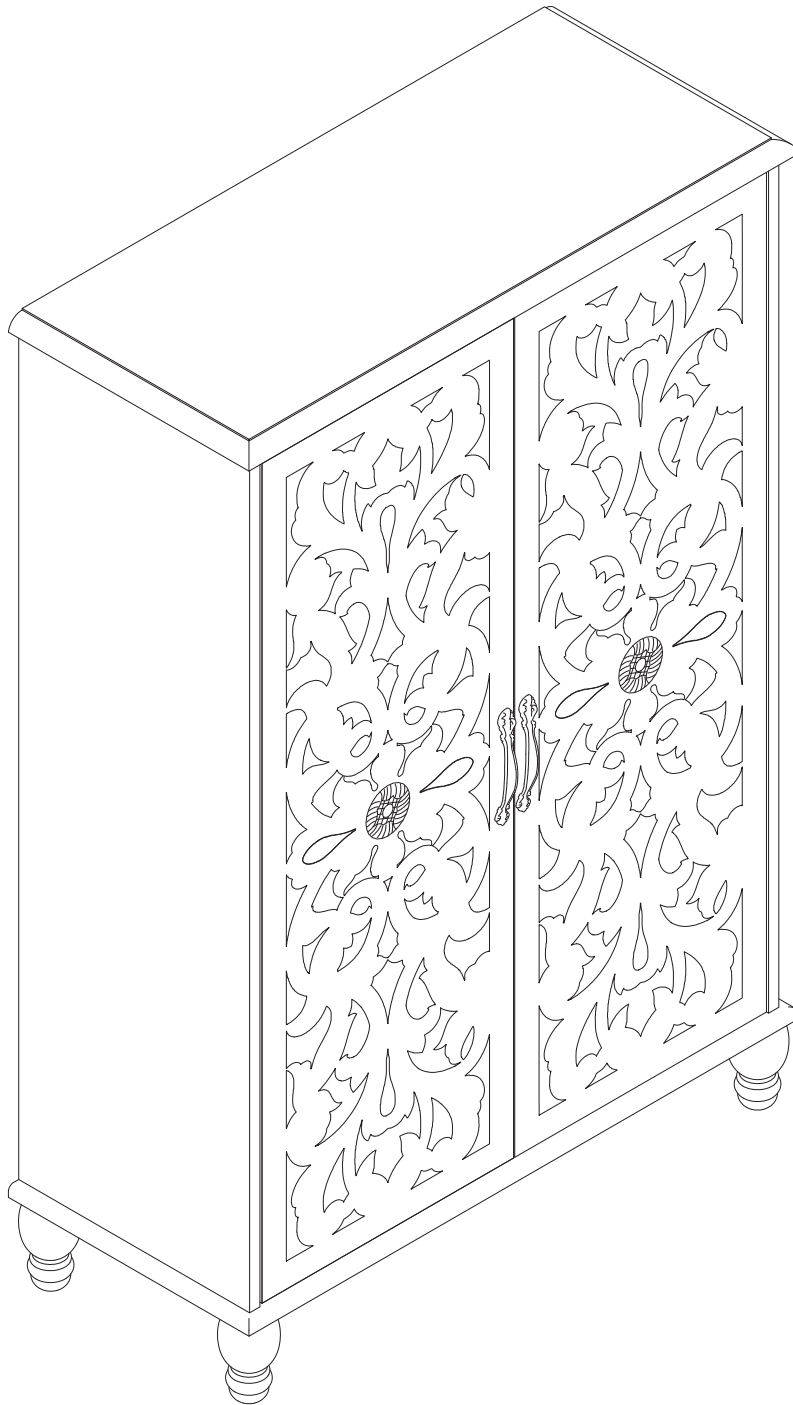

Contact Us

If you have any questions,
Please contact customer service.

Email: service@cozfurn.com

Scan the QR code to watch the installation video.



SAFETY PRECAUTIONS

Before You Start

- ★ Please take the time to carefully read through the whole of these instructions before you commence.
 - ★ Unpack, inspect and check off all of the contents. If there are any defective or missing parts after unpacking, please cease assembly and get in contact with us immediately.
 - ★ Separate and count all your parts and hardware.
 - ★ Have the following tools: Flat Head Screwdriver, #2 Phillips Head Screwdriver and Hammer
-

WARNING

- ★ Do not stand or sit on the product.
 - ★ Children and pets should be kept from your assembly area if possible. Supervise children and pets if they are in the assembly area.
 - ★ Never touch with sharp objects or corrosive chemicals, which may damage the surface of the item.
 - ★ Do not expose product to direct sunlight or rain; and do not put it in a humid place.
-

CAUTION

- ★ This item is heavy. Please handle with care. Two or more people are required for this assembly.
- ★ It would be sensible to lay a sheet or blanket on the floor where you intend to work to avoid scratching this product and to protect your floor.
- ★ Assemble the product as close to its intended final position in the room as possible.
- ★ There may be some odour after unpacking the parcel, please put this item in a ventilated place for a few days and the odour will dissipate.
- ★ If using a power drill or power screwdriver for screwing, please be aware of to slow down and stop when screw is tight.
- ★ Failure to do so may result in stripping the screw.

SAFETY PRECAUTIONS

Wall Mounting & Fixing Guide

NOTE: Supplied wall plugs are only suitable for use in masonry walls.

If you have any doubts about using the correct plug for your wall, please seek professional advice. Failure of the product due to using incorrect fixings is the responsibility of the installer.



IMPORTANT:

When drilling into walls, always check for hidden wires or pipes, etc.



Tips & Tricks

Make sure that the hardware used is suitable for supporting your unit.

Please consult a qualified tradesperson if unsure.

- ✓ If you are unsure, please select a larger screw and wall plug.
- ✓ Ensure that you use the recommended drill bit to match the wall plug and hole size.
- ✓ Take extra care when drilling high walls, ceiling and ceramic tiles. Ensure wall plugs are inserted beyond the thickness of the ceramic tiles to avoid splitting or cracking.
- ✓ Ensure that wall plugs are well fitted and are a tight fit in the drilled hole.

Types Of Walls

Use one of the following types of wall plug (not included) if your walls are made of brick, breeze block, concrete, stone or wood. Screws may be able to be fixed directly to solid wood walls as they will provide a secure anchor point.

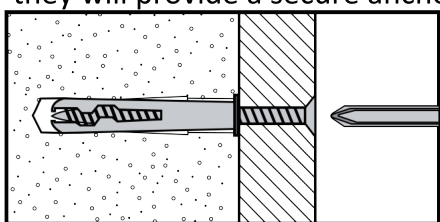

1. General Purpose Wall Plug

Generally, aerated blocks should not be used to support heavy loads, use a specialist fitting in this case. For light loads, general purpose wall plugs can be used.

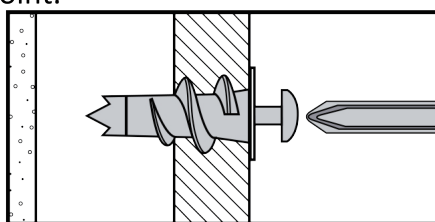

2. Plasterboard Wall Plug

For use when attaching light loads onto plasterboard partitions.

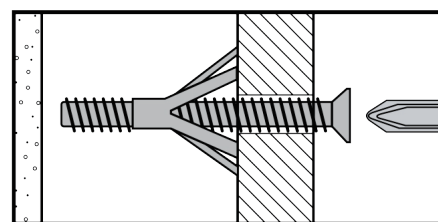

3. Cavity Fixing Wall Plug

For use with plasterboard partitions or hollow wooden doors.

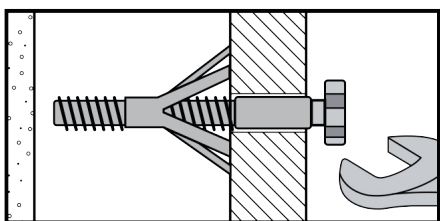

4. Cavity Fixing Heavy Duty Wall Plug

For use when fitting or supporting heavy loads such as shelving and wall cabinets.

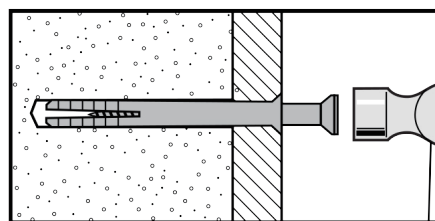

5. Hammer Fixing Wall Plug

For use with concrete block or brick walls, or walls stuck with plasterboard. The hammer fixing allows it to be fixed to the wall rather than the plasterboard. Always check the fixing is secure to the retaining wall.

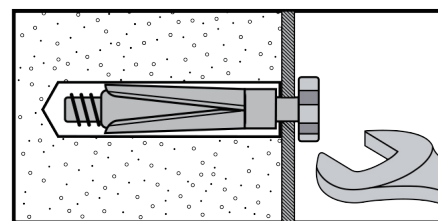

6. Shield Anchor Wall Plug Heavy Loads

For use with concrete or brick walls, or for use with heavier loads such as TV & HiFi speakers and satellite dishes, etc.

SAFETY PRECAUTIONS

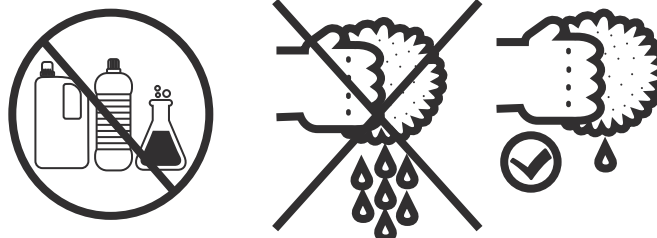
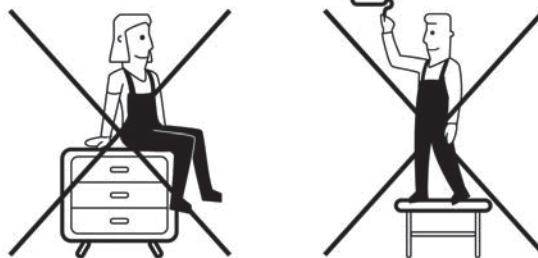
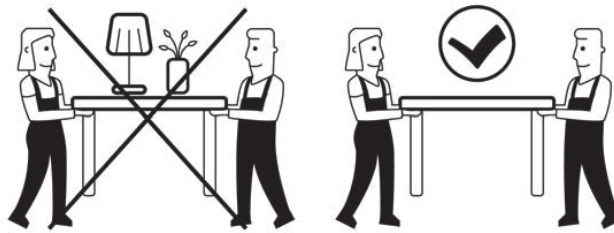
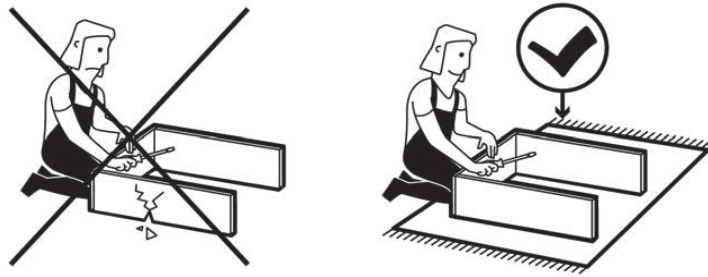
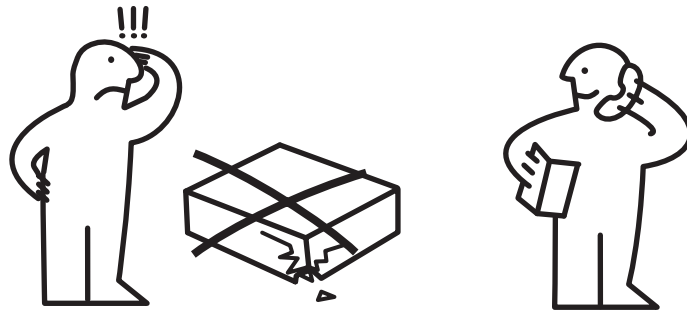

SAFETY PRECAUTIONS

ASSEMBLY TOOLS REQUIRED (NOT INCLUDED)

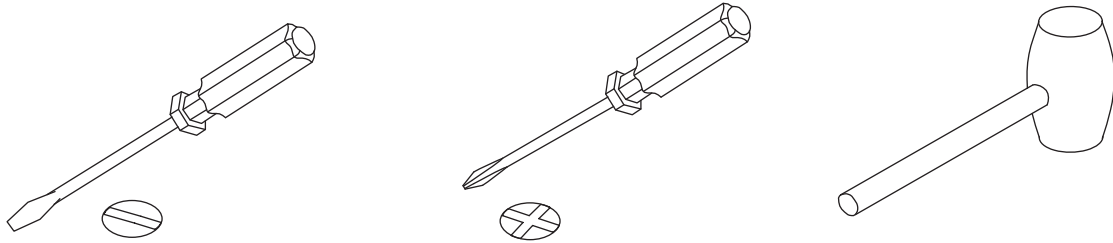

- * Before discarding packing materials, please check all parts and hardware are presented.
- * Please follow the instructions closely.
- * After few days of initial assembly, the product may have acclimated to new environment, please tighten all hardware again.

Dowel Installation

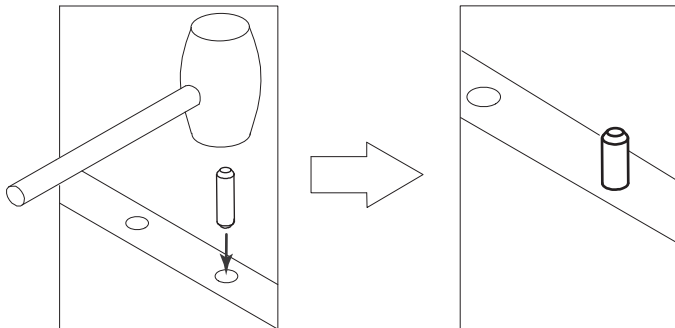

Gently tap dowel into hole with rubber mallet.

CAM-LOCK

Tighten until shoulder is flush with panel. Do not overtighten or undertighten

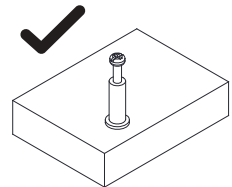
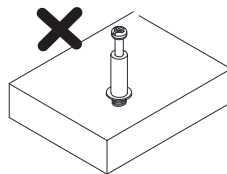
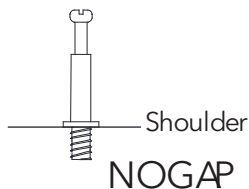

WHEN FITTING CAMS

ENSURE STARTING POSITION IS CORRECT
BEFORE YOU INSERT CONNECTING CAM-PILLAR
TURN CLOCKWISE UNTIL SECURE

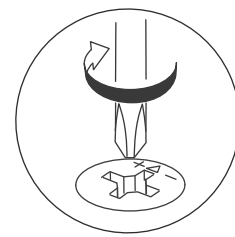
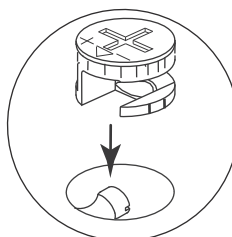
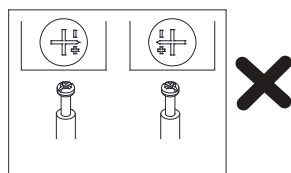
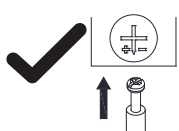

PRODUCT WARRANTY INSTRUCTION



Free Warranty Period:

The free warranty period starts from the product receipt date and lasts one year.



Coverage during the Free Warranty Period:

1. If any components of the purchased product are damaged due to non-human-induced reasons natural wear and tear excluded corresponding new parts will be replaced free of charge.

2. If the entire purchased product is damaged due to non-human-induced reasons natural wear and tear excluded and cannot be further used, corresponding parts or a brand-new product will be replaced free of charge.



Coverage after the Free Warranty Period:

After the warranty period expires, replacement components will be provided to customers at cost price for continued service.



Additional Services:

After purchasing the product, customers can consult our staff for any product-related inquiries.



Contact Email : Service@cozfurn.com

ACCESSORIES DISPLAY

Laying out all the parts and hardware and identifying each part as shown below. It may help you when you assemble the item.

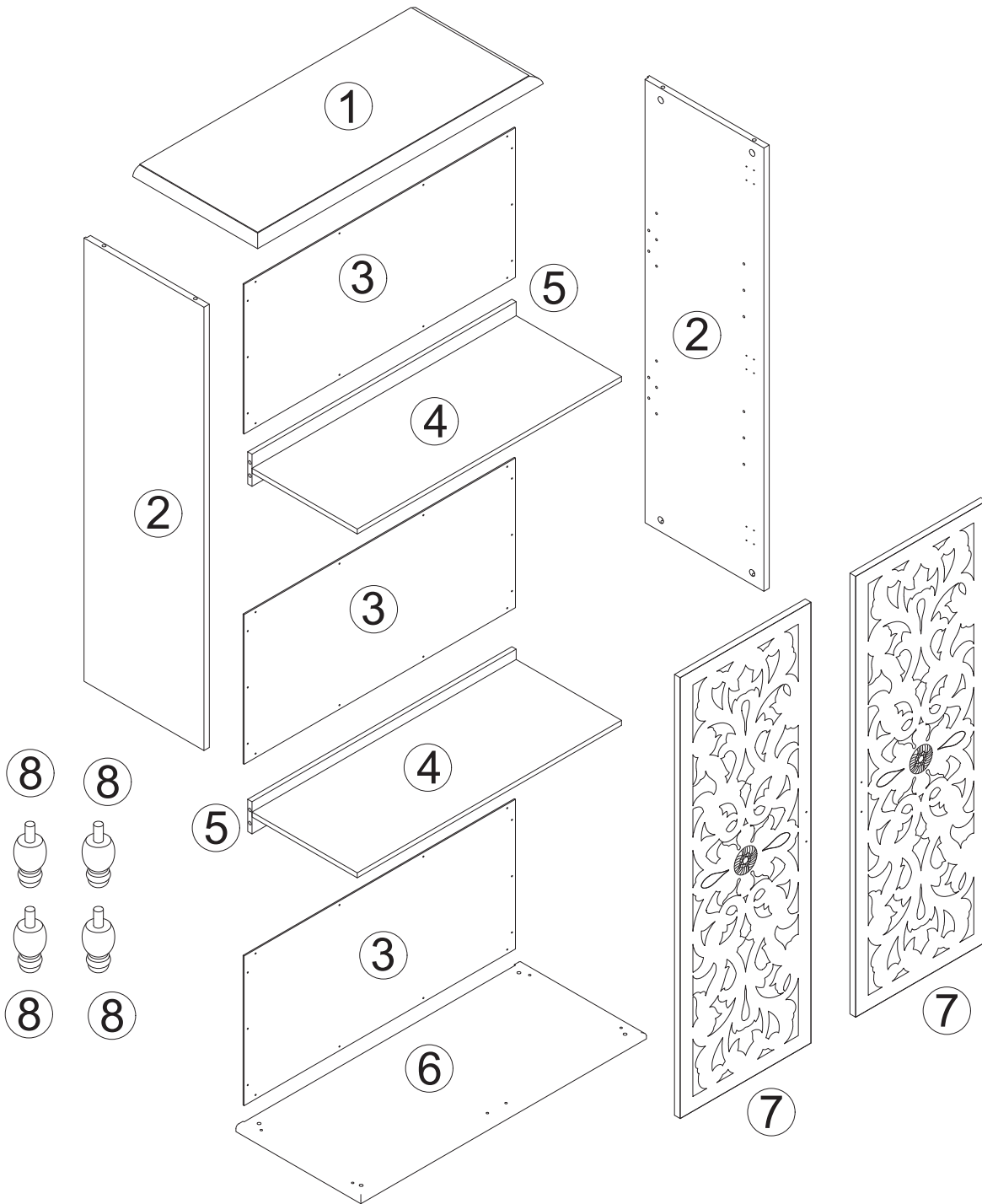

① × 1	② × 2	③ × 3	④ × 2	⑤ × 2	⑥ × 1	⑦ × 2	⑧ × 4
-------	-------	-------	-------	-------	-------	-------	-------

PRODUCT ASSEMBLY

STEP 1

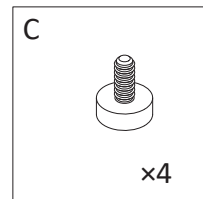
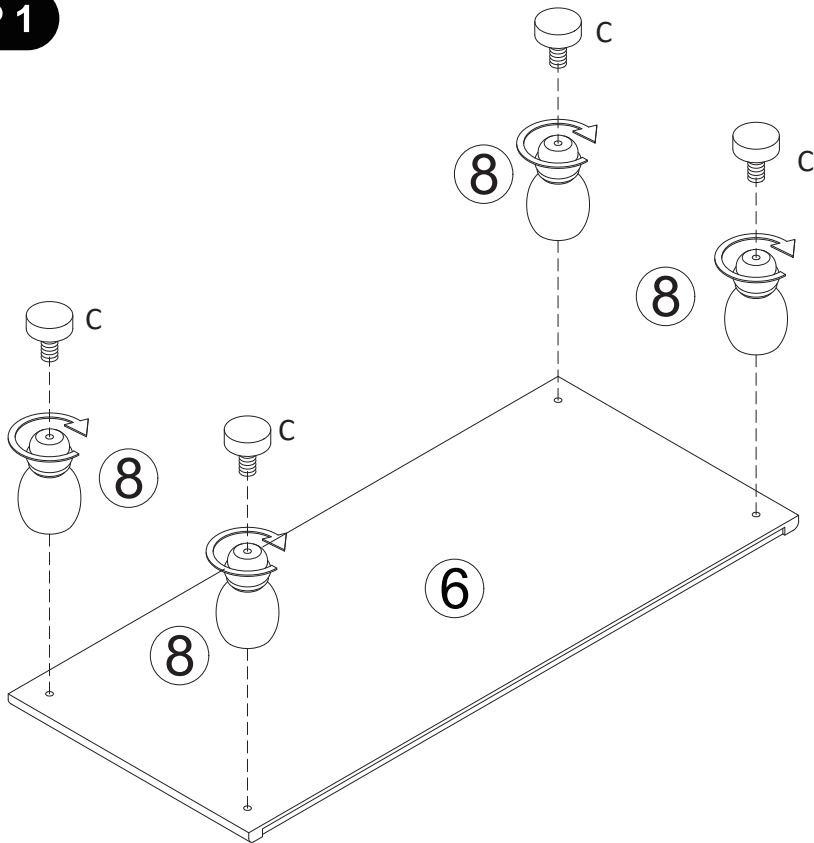

STEP 2

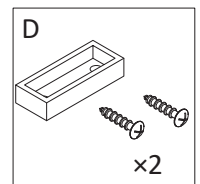
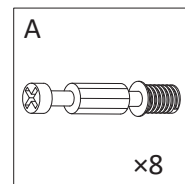
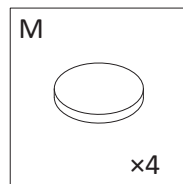
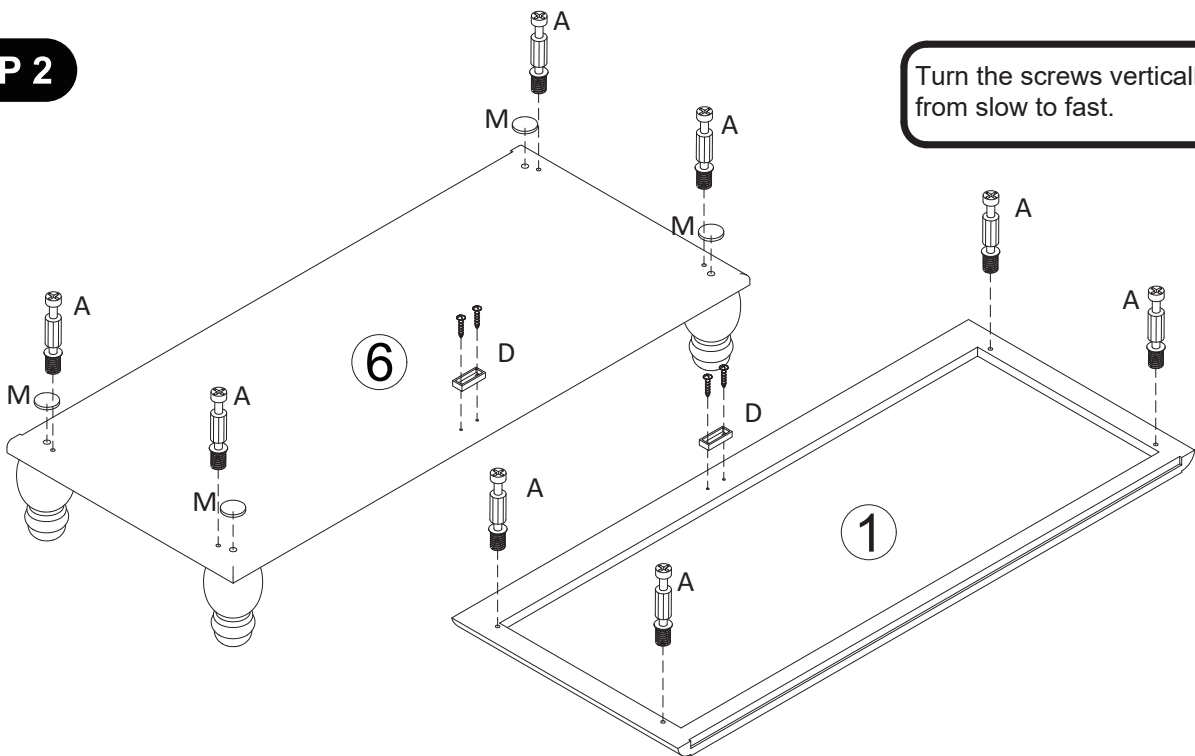

PRODUCT ASSEMBLY

STEP 3

Turn the screws vertically from slow to fast.

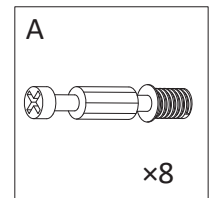
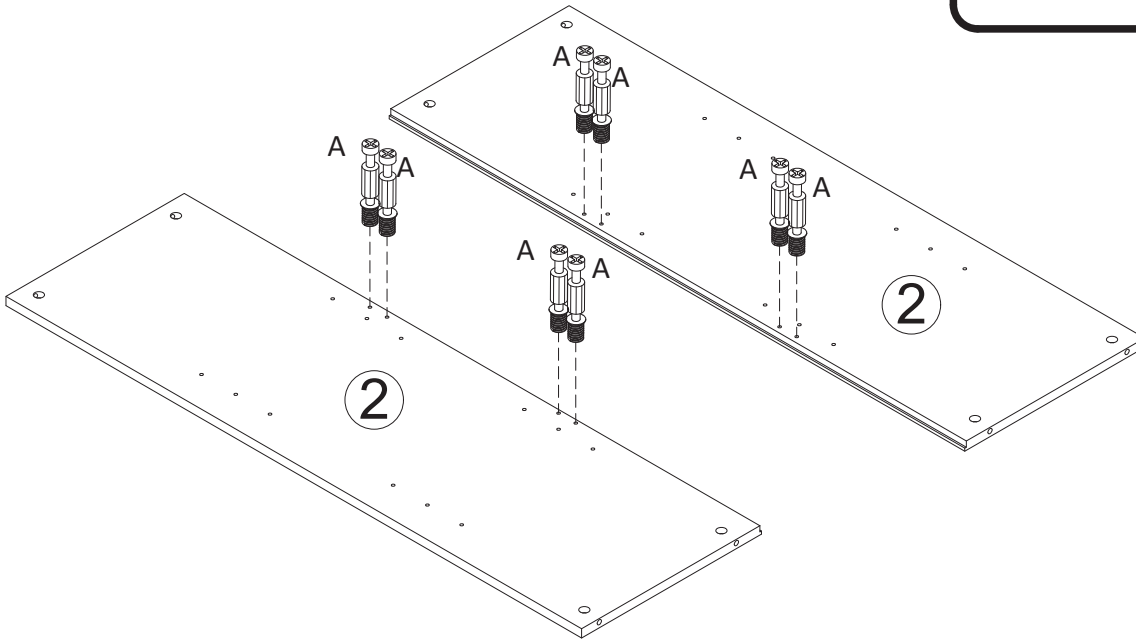

STEP 4

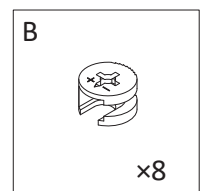
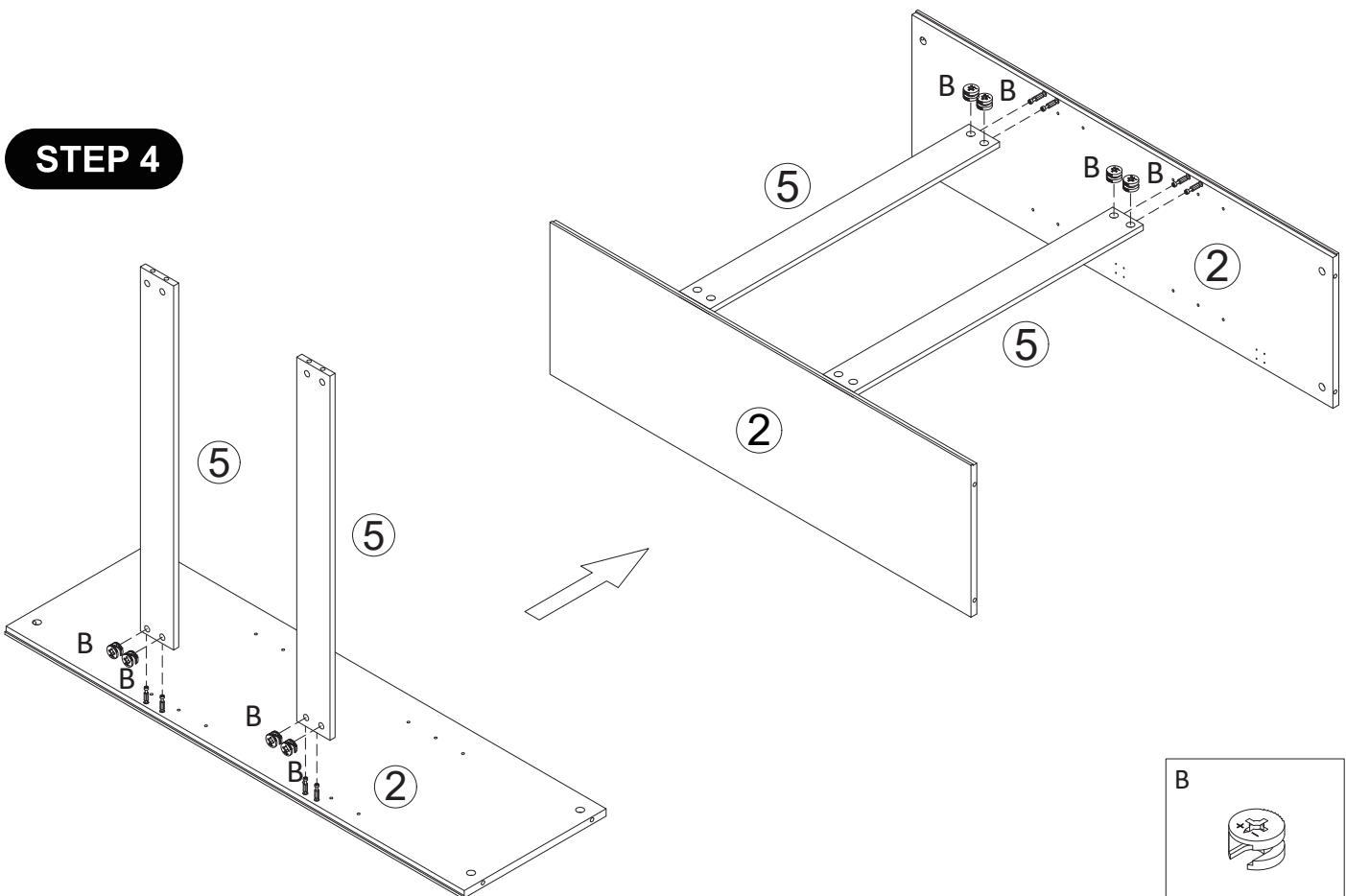

PRODUCT ASSEMBLY

STEP 5

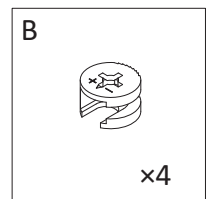
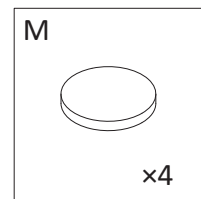
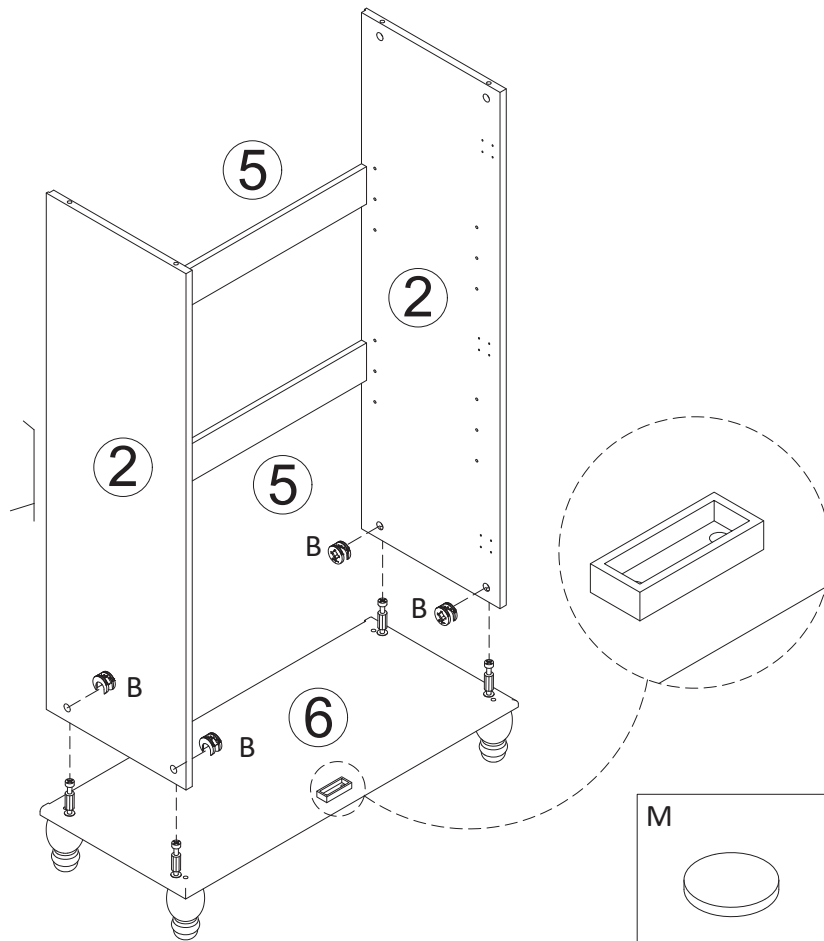
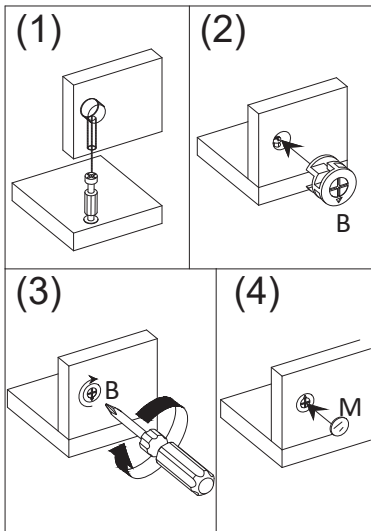

STEP 6

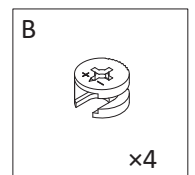
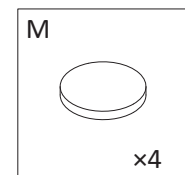
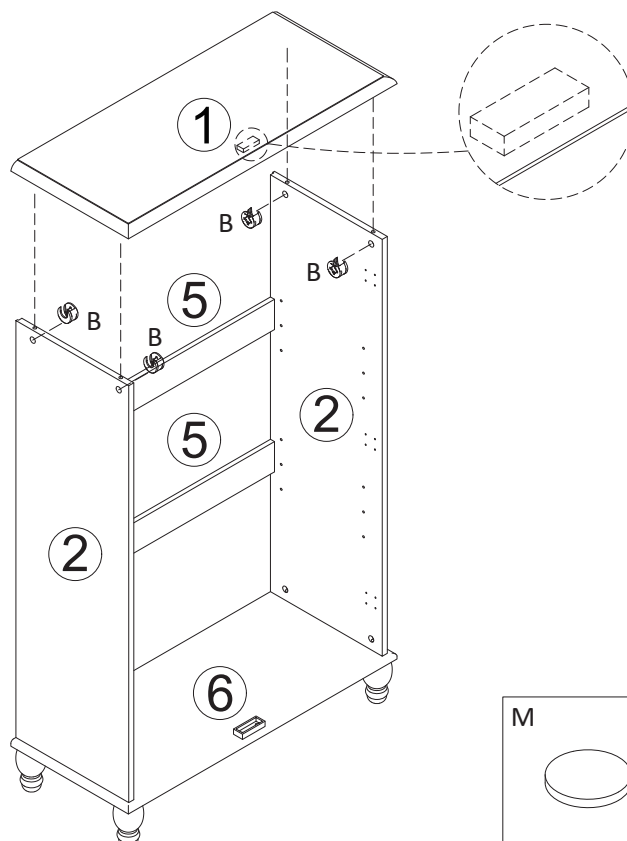
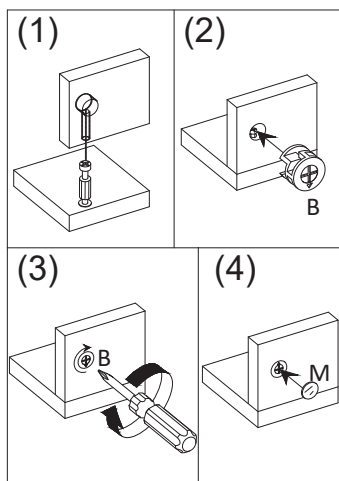

PRODUCT ASSEMBLY

STEP 7

Turn the screws vertically from slow to fast.

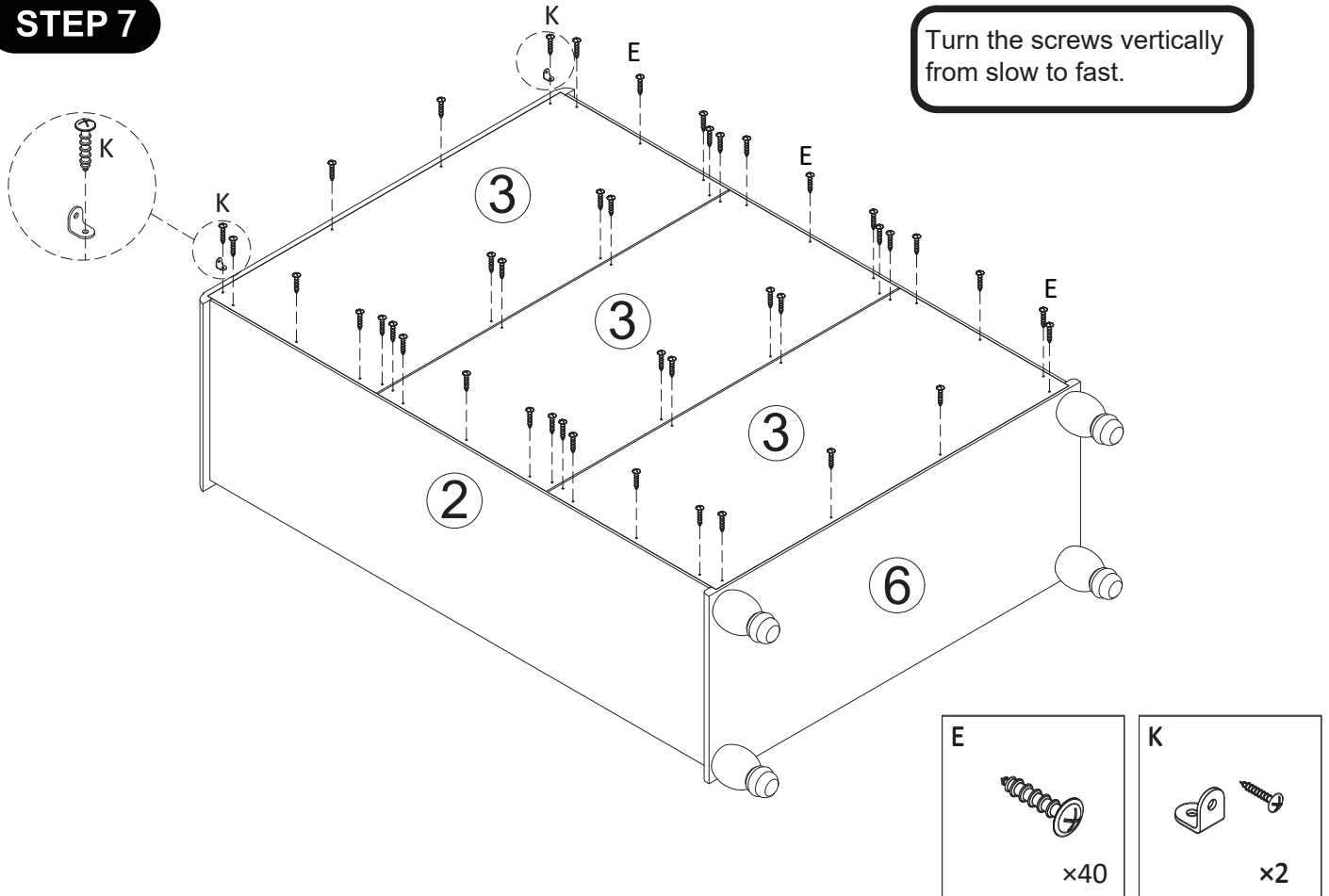

STEP 8

Turn the screws vertically from slow to fast.

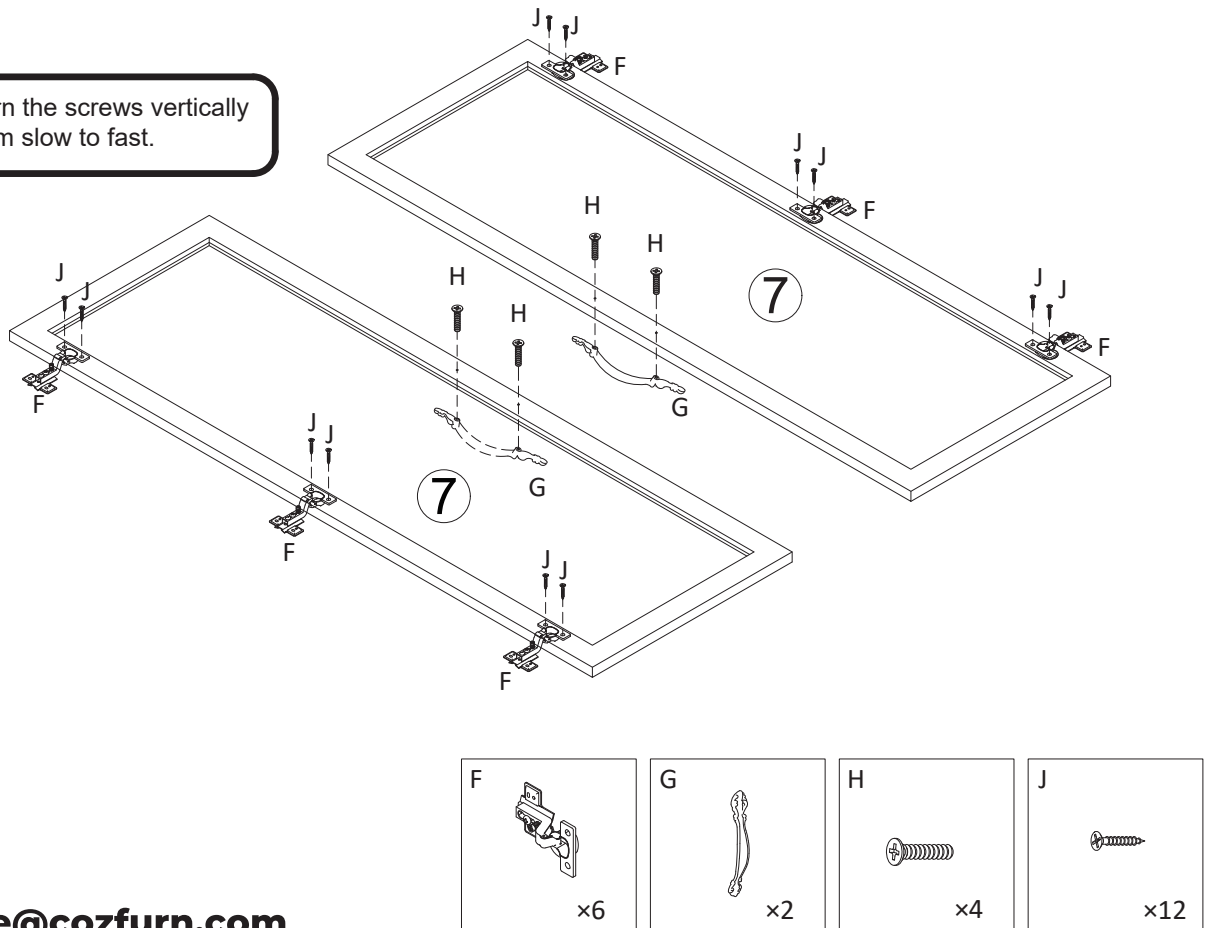

PRODUCT ASSEMBLY

STEP 9

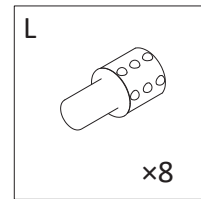
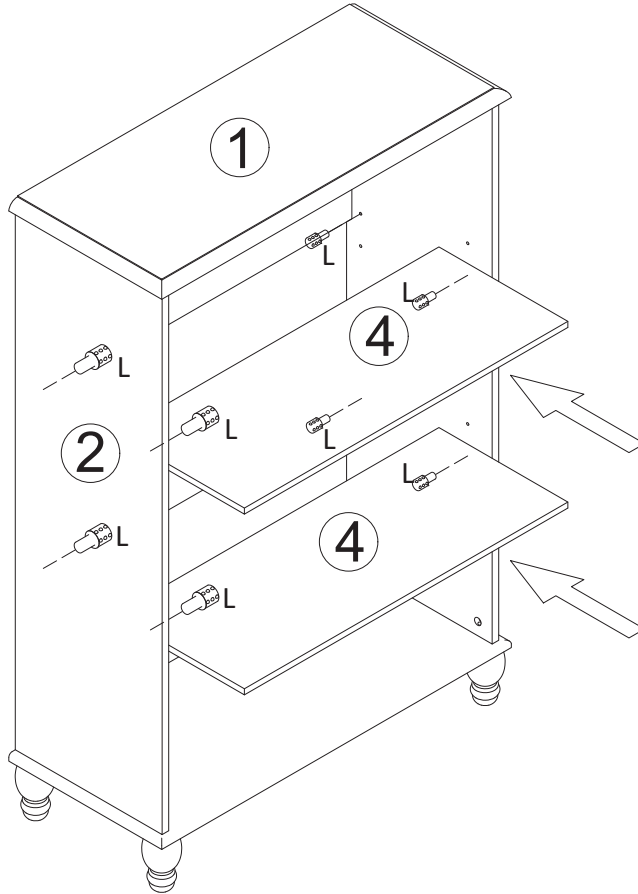

PRODUCT ASSEMBLY

STEP 10

STEP (1)

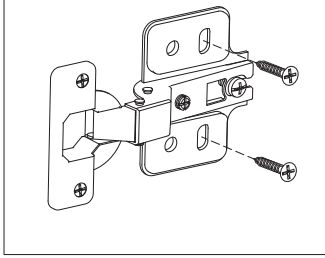

Tips: Turning the screw to approx 50% tightness, don't be fully tight.

STEP (2)

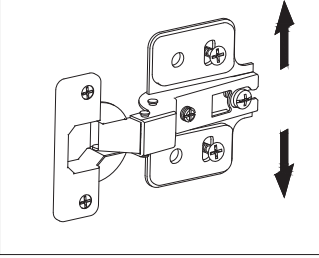

Tips: Moving the hinges up or down appropriately to adjust the gap between the door with the cabinet top and bottom.

STEP (3)

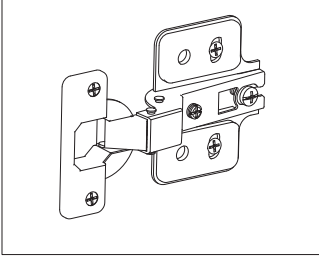

Tips: Tightening the screws completely.

STEP (4)

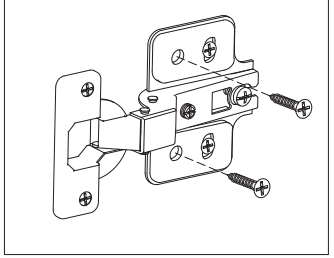

Tips: Tightening the other screws completely.

Turn the screws vertically from slow to fast.

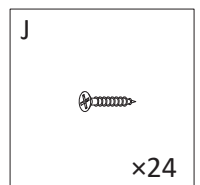
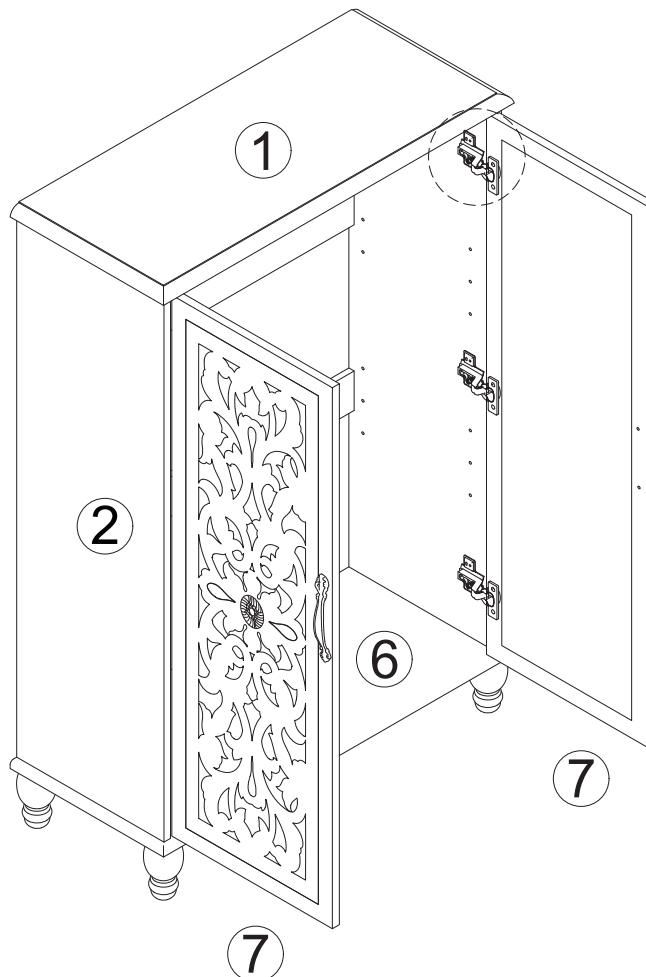
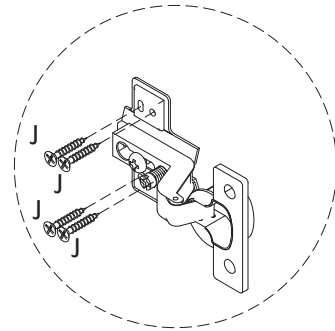

PRODUCT ASSEMBLY

STEP 11

Tips: If the gap between two doors is too far or close, please turning the screw as shown below.

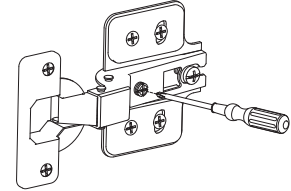
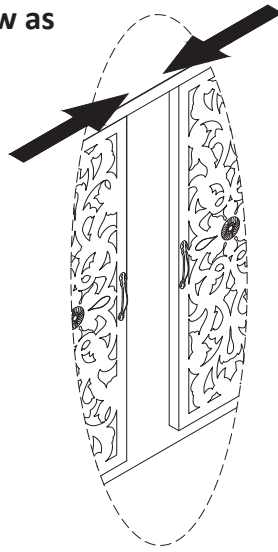
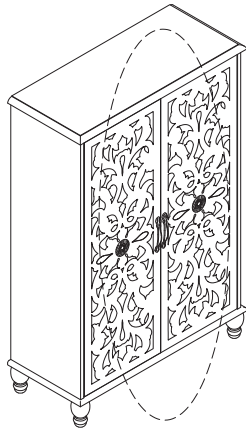

Tips: Adjusting the screw as shown in the following picture can make the door move forward or backward.

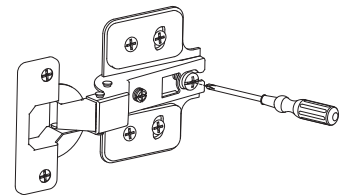
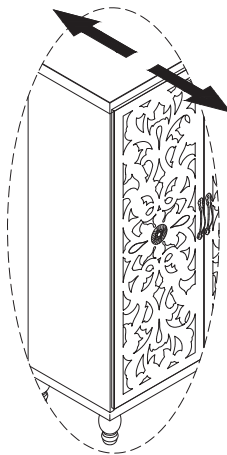
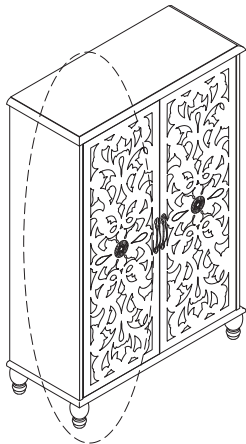

Tips: Adjusting the levelers appropriately underneath the bottom of the foot can make the gaps between the door and frames of cabinet even.

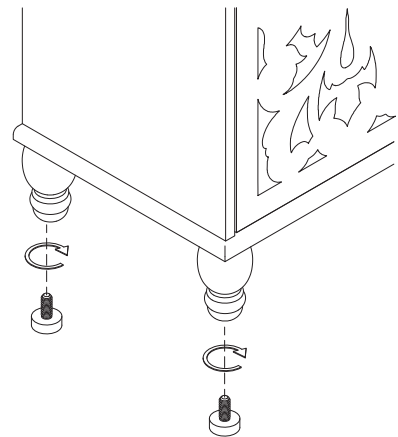
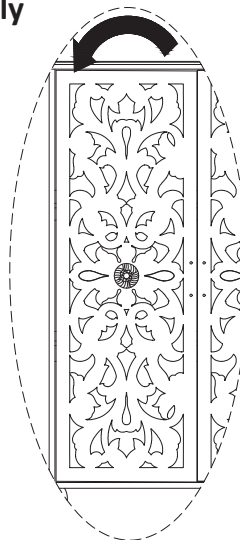
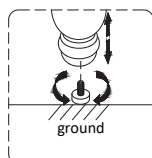
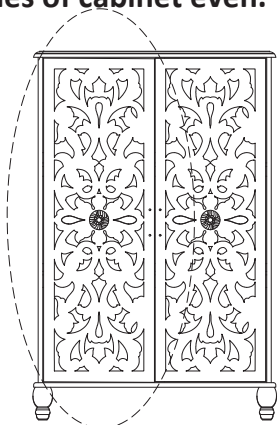

PRODUCT ASSEMBLY

STEP 12

