

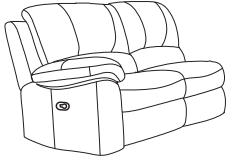

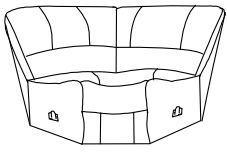

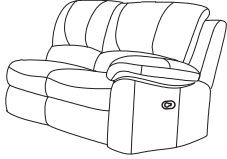
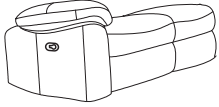
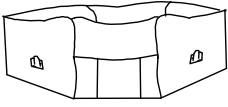
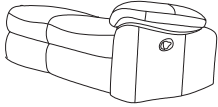

Assembly Instruction

Thank you for purchasing this quality product! Make sure all components and small hardware parts are included in the package before you start to assemble the product.

Left Arm			Wedge			Right Arm		
								
Part No.	Description and Drawing	Qty.	Part No.	Description and Drawing	Qty.	Part No.	Description and Drawing	Qty.
A	Left Arm Base 	1	D	Wedge Base 	1	G	Right Arm Base 	1
B	Left Arm Back Left 	1	E	Wedge Back Left 	1	H	Right Arm Back Left 	1
C	Left Arm Back Right 	1	F	Wedge Back Right 	1	I	Right Arm Back Right 	1

*Please keep these instructions and have the product model # and part # available when requesting a service.

Step 1:

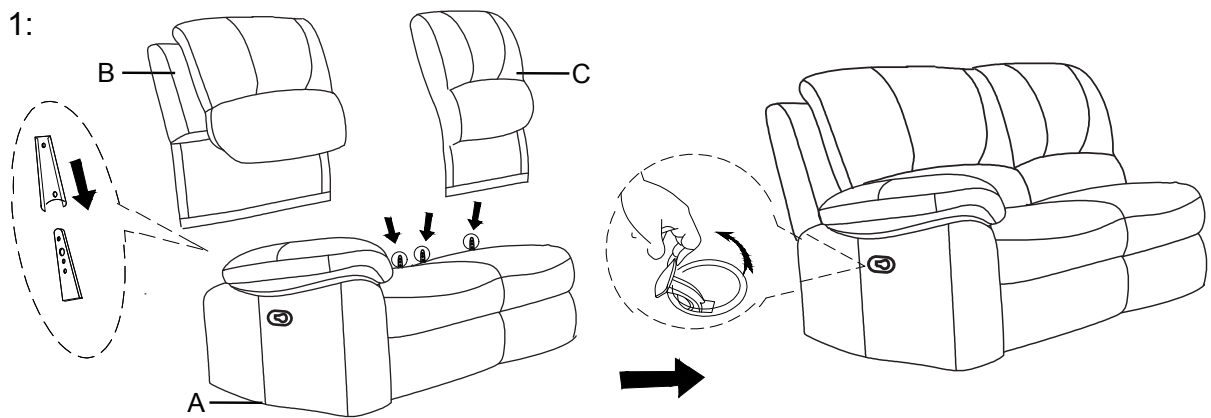

Step 2:

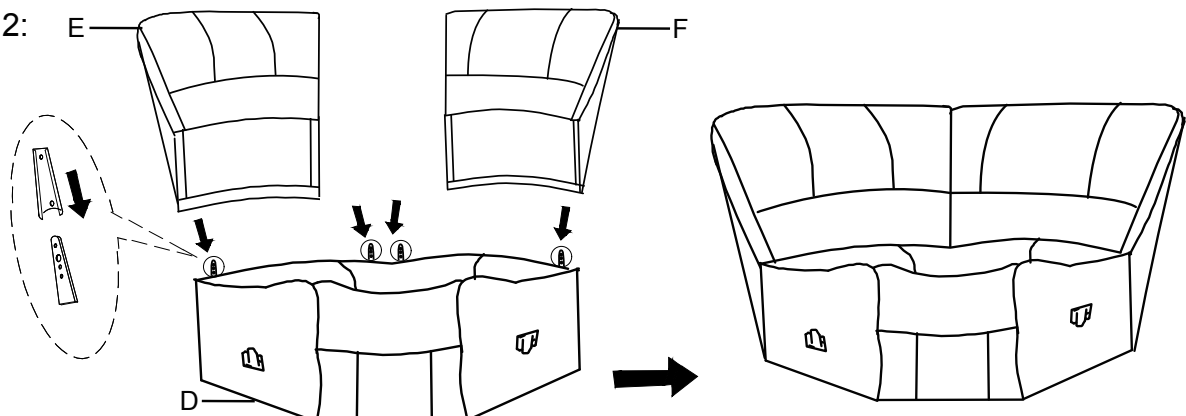

Step 3:

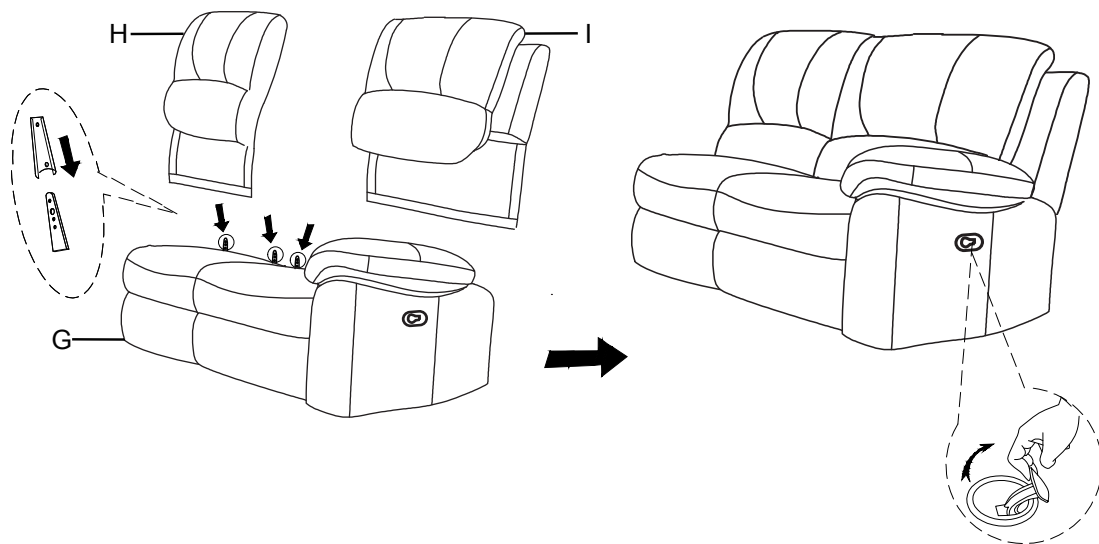

Step 4:

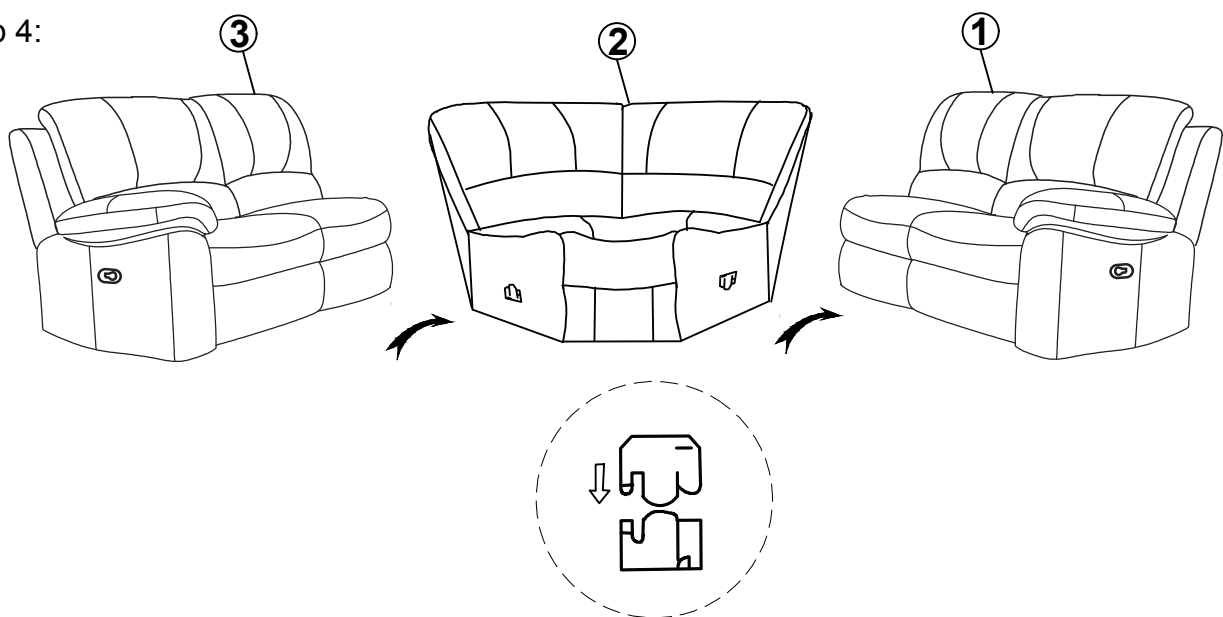

To connect your sectional pieces, start with the piece on the right side (#1) when facing the sectional. Hook the male connector of the right facing side of the wedge #2 into the female connector on the bottom of item #1, continue connecting the remaining sectional piece in order. To disconnect, go in the reverse direction, in the drawing below you would begin with #3.

Completed

