

KitchenCraft	
Brand:	INDUSTRIAL KITCHEN
Code:	INDCEILRACK INSTRUCTIONS
Dimensions:	A4: (W)210mm x (H)297mm
Cutter:	— (do not print), - - - - - (fold line, do not print)
Material:	100gms
Finish:	Matt laminate
Colours:	CMYK

COPYRIGHT ©
KITCHENCRAFT (THOMAS PLANT, BIRMINGHAM LTD)
2016

FRONT



CONTENTS

A | LONG BOLT B | SHORT BOLT C | DOME NUT
D | CEILING HOOK E | LINK F | BRACKET G | HANGING HOOK
H | NUT I | UPRIGHT BAR J | RACK K | SUPPORT BAR

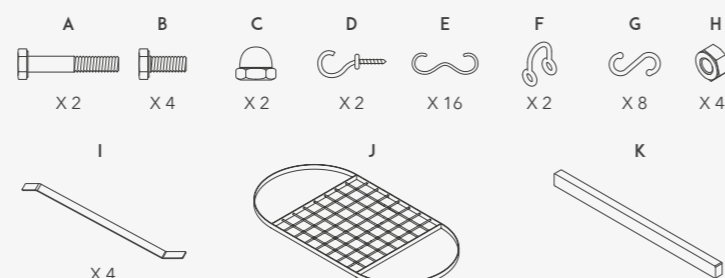

HOW TO ASSEMBLE

- 1 | ENSURE THE HANGING HOOKS ARE SCREWED FULLY INTO THE CEILING JOISTS
 - 2 | USING THE BRACKETS, FASTEN THE UPRIGHT BARS WITH LONG BOLT AND NUT TO BOTH ENDS OF THE WOODEN SUPPORT BAR
 - 3 | FASTEN THE UPRIGHT BARS TO ALL FOUR CORNERS OF THE SQUARE SECTION OF THE RACK, USING THE SHORT BOLT AND NUT
 - 4 | USE THE APPROPRIATE NUMBER OF LINKS ON EACH OF THE HANGING HOOKS SO THAT THE RACK HANGS AT THE APPROPRIATE HEIGHT FOR YOUR NEEDS
- EXTRA HOOKS ARE AVAILABLE SEPARATELY
IF ANY PARTS ARE MISSING, PLEASE CONTACT CUSTOMER SERVICE AT WWW.KITCHENCRAFT.CO.UK

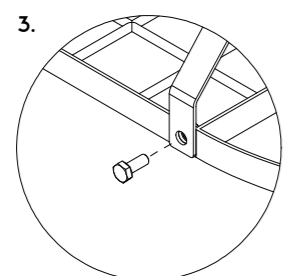
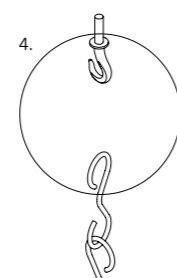
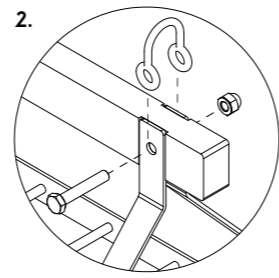
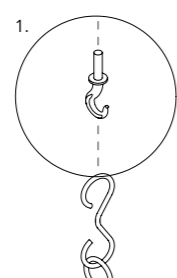
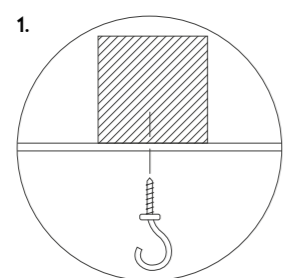

3.

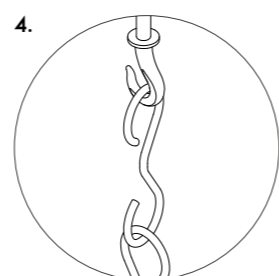

4.

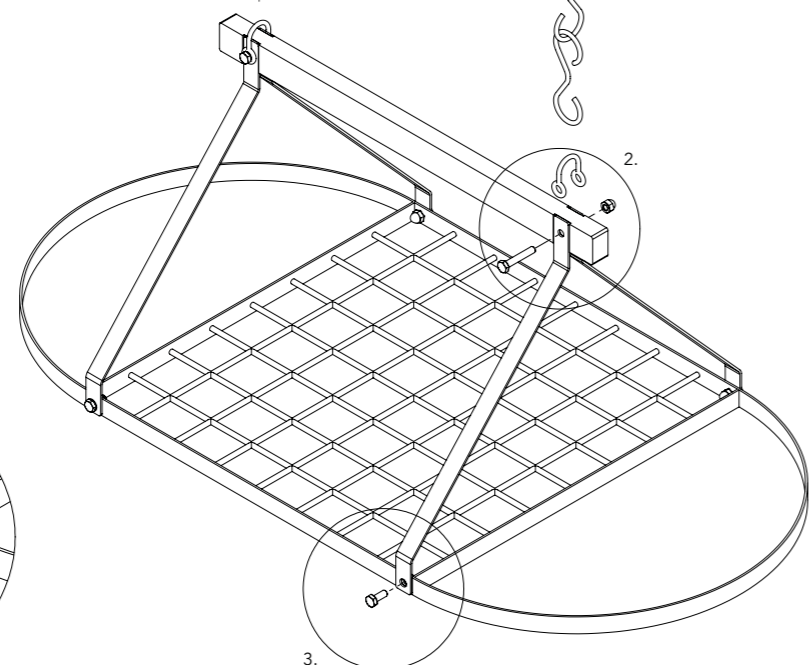

BACK

F | PORTE-CASSEROLES SUSPENDU

CONTENU

A | BOULON LONG B | BOULON COURT C | ECROU ROND
D | CROCHET DE SUSPENSION E | MAILLON F | ATTACHE G | CROCHET DE
SUSPENSION H | ECROU I | BARRE MONTANTE J | RÂTELIER K | BARRE DE
SUPPORT

INSTRUCTIONS D'ASSEMBLAGE

- 1 | ASSUREZ-VOUS QUE LES CROCHETS DE SUSPENSION SONT BIEN VISSÉS DANS LES SOLIVES DU PLAFOND
 - 2 | À L'AIDE DES ATTACHES, FIXEZ LES BARRÉS MONTANTES AVEC LE BOULON LONG ET L'ECROU AUX DEUX EXTRÉMITÉS DE LA BARRE DE SUPPORT EN BOIS
 - 3 | FIXEZ LES BARRÉS MONTANTES À CHACUN DES QUATRE COINS DE LA PARTIE CARRÉE DU RÂTELIER, À L'AIDE DU BOULON COURT ET DE L'ECROU
 - 4 | UTILISEZ LE NOMBRE ADÉQUAT DE MAILLONS SUR CHACUN DES CROCHETS DE SUSPENSION DE MANIÈRE À CE QUE LE RÂTELIER SOIT SUSPENDU À LA BONNE HAUTEUR POUR VOS BESOINS
- DES CROCHETS SUPPLÉMENTAIRES SONT DISPONIBLES SÉPARÉMENT
S'IL MANQUE DES PIÈCES, VEUILLEZ CONTACTER LE SERVICE CLIENTÈLE CHEZ WWW.KITCHENCRAFT.CO.UK

D | DECKENREGAL

INHALT

A | LANGE SCHRAUBE B | KURZE SCHRAUBE C | RUNDMUTTER
D | SCHRAUBHAKEN E | HÄNGEGLIED F | HALTBÜGEL G | WANDSTREBE
H | MUTTER I | HALTESTREBE J | REGALBORD K | GESTELLTRÄGER

MONTAGE

- 1 | SICHERSTELLEN, DASS DIE SCHRAUBHAKEN VOLL IN DIE DECKENBALKEN EINGESCHRAUBT SIND
 - 2 | JEWEILS ZWEI HALTESTREBEN AN BEIDEN ENDEN DES HÖLZERNEN GESTELLTRÄGERS ENTSPRECHEND PLATZIEREN, HALTBÜGEL DARÜBER SCHIEBEN UND LANGE SCHRAUBE VOLL DURCHSTECKEN AUF FREIES SCHREIBENDE AUFSTECKEN UND MUTTER DARAN FESTSCHRAUBEN
 - 3 | MIT DEN VIER KURZEN SCHRAUBEN UND MUTTERN DIE HALTESTREBEN AN ALLEN VIER GITTERECKEN DES GESTELLTRÄGERS BEFESTIGEN
 - 4 | SO VIELE HÄNGEGLIEDER AN BEIDEN SCHRAUBHAKEN BEFESTIGEN, DASS NACH DEM ANBRINGEN DER JEWEILS UNTERSTEN GLIEDER AN DEN HALTBÜGELN DAS REGAL IN DER GEWÜNSCHTEN HÖHE HÄNGT
- ZUSÄTZLICHE HÄNGEGLIEDER SIND SEPARAT ERHÄLTICH
FALLS IRGENDWELCHE TEILE FEHLEN SOLLTEN, KONTAKTIEREN SIE BITTE DEN KUNDENDIENST (CUSTOMER SERVICE) BEI WWW.KITCHENCRAFT.CO.UK

E | COLGADOR DE TECHO

CONTENIDO

A | PERNO LARGO B | PERNO CORTO C | TUERCA REDONDA
D | GANCHO DE COLGAR E | UNIÓN F | APLIQUE G | GANCHO DE COLGAR
H | TUERCA I | BARRA RECTA J | COLGADOR K | BARRA SOPORTE

MONTAJE

- 1 | ASEGÚRESE DE QUE LOS GANCHOS DE COLGAR ESTÉN COMPLETAMENTE ATORNILLADOS A LAS VIGAS DEL TECHO
 - 2 | UTILIZANDO LOS APLIQUES, SUJETE LAS BARRAS RECTAS CON LOS PERNOS LARGOS Y TUERCAS A AMBOS EXTREMOS DE LA BARRA SOPORTE DE MADERA
 - 3 | SUJETE LAS BARRAS RECTAS A LAS CUATRO ESQUINAS DE LA SECCIÓN CUADRADA DEL COLGADOR, UTILIZANDO LOS PERNOS CORTOS Y TUERCAS
 - 4 | UTILICE EL NÚMERO APROPIADO DE ENLACES EN CADA UNO DE LOS GANCHOS DE COLGAR, PARA QUE EL COLGADOR CUELGA A LA ALTURA APROPIADA PARA SUS NECESIDADES
- SE PUEDEN OBTENER GANCHOS ADICIONALES POR SEPARADO
SI FALTARAN PIEZAS, POR FAVOR, PÓNGASE EN CONTACTO CON SERVICIO AL CLIENTE DE WWW.KITCHENCRAFT.CO.UK

I | RASTRELLIERA DA SOFFITTO

CONTENUTO

A | BULLONE LUNGO B | BULLONE CORTO C | DADO ROTONDO
D | GANCIO DI SOSPENSIONE E | STAFFA F | RACCORDO G | GANCIO
H | DADO I | BARRA MONTANTE J | RASTRELLIERA K | BARRA DI SUPPORTO

ASSEMBLAGGIO

- 1 | ASSICURARSI DI AVVITARE COMPLETAMENTE I GANCI DI SOSPENSIONE NELLE TRAVI DEL SOFFITTO
 - 2 | AVVALENDOSI DELLE STAFFE, FISSARE LE BARRE MONTANTI AD ENTRAMBE LE ESTREMITÀ DELLA BARRA DI SUPPORTO IN LEGNO CON IL BULLONE LUNGO E IL DADO
 - 3 | FISSARE LE BARRE MONTANTI AI QUATTRO ANGOLI DELLA SEZIONE QUADRATA DELLA RASTRELLIERA, UTILIZZANDO IL BULLONE CORTO E IL DADO
 - 4 | UTILIZZARE IL NUMERO DI RACCORDI NECESSARIO PER OGNI GANCIO DI SOSPENSIONE IN MODO CHE LA RASTRELLIERA SI TROVI ALL'ALTEZZA DESIDERATA DALL'UTENTE
- I GANCI AGGIUNTIVI SONO DISPONIBILI SEPARATAMENTE
QUALORA CI FOSSERO PEZZI MANCANTI, RIVOLGERSI AL SERVIZIO CLIENTI WWW.KITCHENCRAFT.CO.UK

P | SUPORTE PARA PANELAS

CONTEUDO

A | PARAFUSO COMPRIDO B | PARAFUSO CURTO C | PORCA REDONDA
D | GANCHO PARA PENDURAR E ELO E | SUPORTE F | SUPORTE J | GANCHO DE
SUSPENSÃO H | PORCA I | BARRA VERTICAL J | SUPORTE K | BARRA DE SUPORTE

MONTAGEM

- 1 | VERIFIQUE QUE OS GANCHOS PARA PENDURAR ESTÃO DEVIDAMENTE FIXOS NO TETO
 - 2 | COM OS SUPORTES, APORTE AS BARRAS VERTICAIS COM O PARAFUSO COMPRIDO E PORCA ÀS EXTREMIDADES DA BARRA DE SUPORTE.
 - 3 | APORTE AS BARRAS VERTICAIS AOS QUATRO CANTOS DA PARTE QUADRADA DO SUPORTE, UTILIZANDO O PARAFUSO CURTO E PORCA
 - 4 | UTILIZE OS ELOS NECESSÁRIOS EM CADA GANCHO DE PENDURAR PARA QUE O SUPORTE FIQUE PENDURADO À SUA ALTURA DESEJADA
- PODE OBTER GANCHOS EXTRA. SE FALTAR QUALQUER PEÇA, CONTACTE O SERVIÇO DE APOIO AO CLIENTE DA WWW.KITCHENCRAFT.CO.UK

297mm



KitchenCraft
a Lifetime Brands company

BIRMINGHAM, B6 7EU, GB
WWW.KITCHENCRAFT.CO.UK

MADE IN INDIA

KITCHEN IMAGE PROVIDED BY SNAIDERO

210mm