

Owner Manual

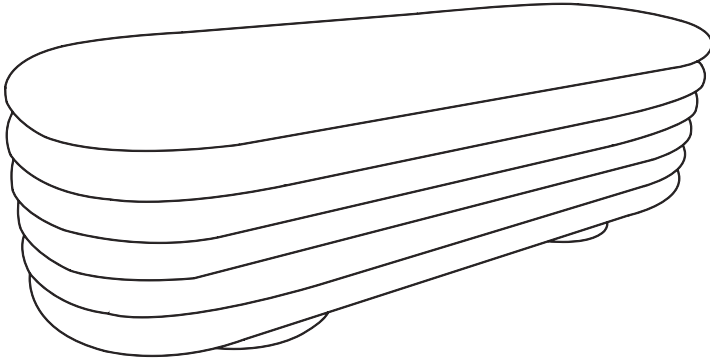

Per Seat Weight Limitation

500 LBS

Thank You For Choosing Our Furniture

▾ If you have any questions or concerns,
don't hesitate to reach out to us. ▴

NOTE:







This brochure contains
IMPORTANT safety info.
Please read and keep it
for future reference.

MAINTENANCE AND WARNINGS



Before You Start

Please follow the steps below:



-  Un box the package and check if all parts and accessories are complete.
-  Place the parts of the chair on a flat surface.
-  Ensure the chair is placed on a stable, flat surface to prevent it from tilting.
-  Avoid placing sharp or heavy objects directly on the chair to prevent tears or deformation.
-  Clean the installation area in advance and ensure the ground is level and there is enough space to avoid damaging the furniture or making installation difficult.
-  Lay a protective mat on the ground to prevent scratching the floor during installation.

After-Sales Service

- If you encounter any issues or need technical support during use, please contact our after-sales team. We offer long-term maintenance and warranty services.





Precautions

-  This chair is for indoor use only. Do not expose it to outdoor elements or high-humidity environments.
-  Keep the product away from high heat or open flames to prevent fire hazards.
-  Do not allow children or pets to play on the chair unsupervised to avoid accidents.



Safety Warnings

-  If you notice any loose or damaged parts, stop using the sofa immediately and contact customer service.
-  Do not attempt to disassemble or replace any components yourself, as this may affect the stability and safety of the product.



Daily Maintenance

- Regularly clean the surface of the sofa with a chair cloth to prevent dust accumulation.
- For fabric chairs, it is recommended to vacuum weekly and clean the fabric as needed.
- For leather chairs, use a leather cleaner regularly to clean and maintain the material. Avoid direct sunlight to prevent leather aging.
- In case of spills, immediately blot the area with a clean, dry cloth

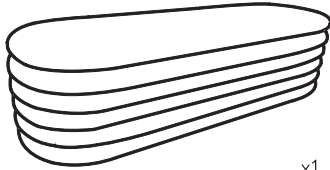
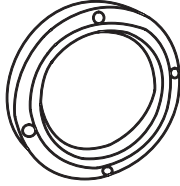

Parts List

<p>A</p>  <p>x1</p> <p>Seat Frame</p>	<p>B</p>  <p>x2</p> <p>At the tommom of A Round Leg</p>
---	---

Hardware List

<p>1 X4</p>  <p>Bolt</p> <p>Ø6x30mm</p>	<p>2 X1</p>  <p>Allen Key</p> <p>M6</p>	<p>3 X4</p>  <p>Flat Washer</p>
---	---	---

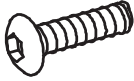
Hardware Spare List

<p>1 X1</p>  <p>Bolt</p> <p>Ø6x30mm</p>	<p>3 X1</p>  <p>Gaskets</p>	
---	---	--

3



Installation:
15minutes.



Two Person

Step 1

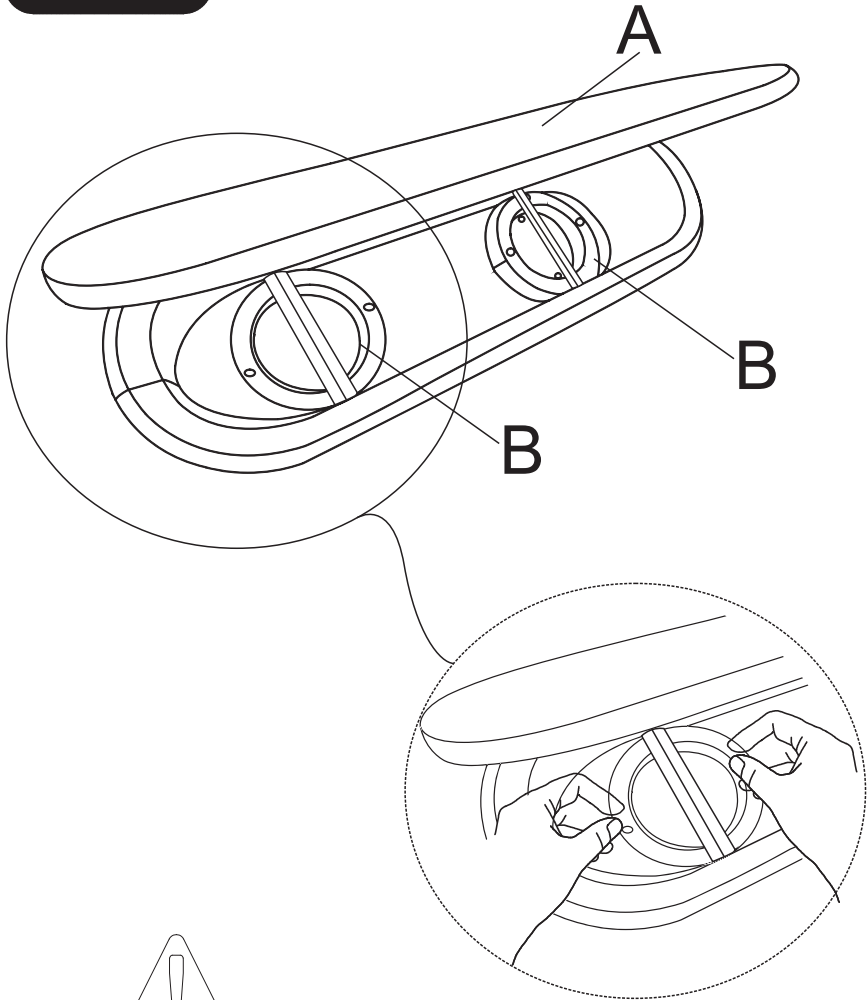

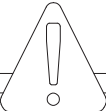

**Pull the drawstring,
and take out part B**

Step 2

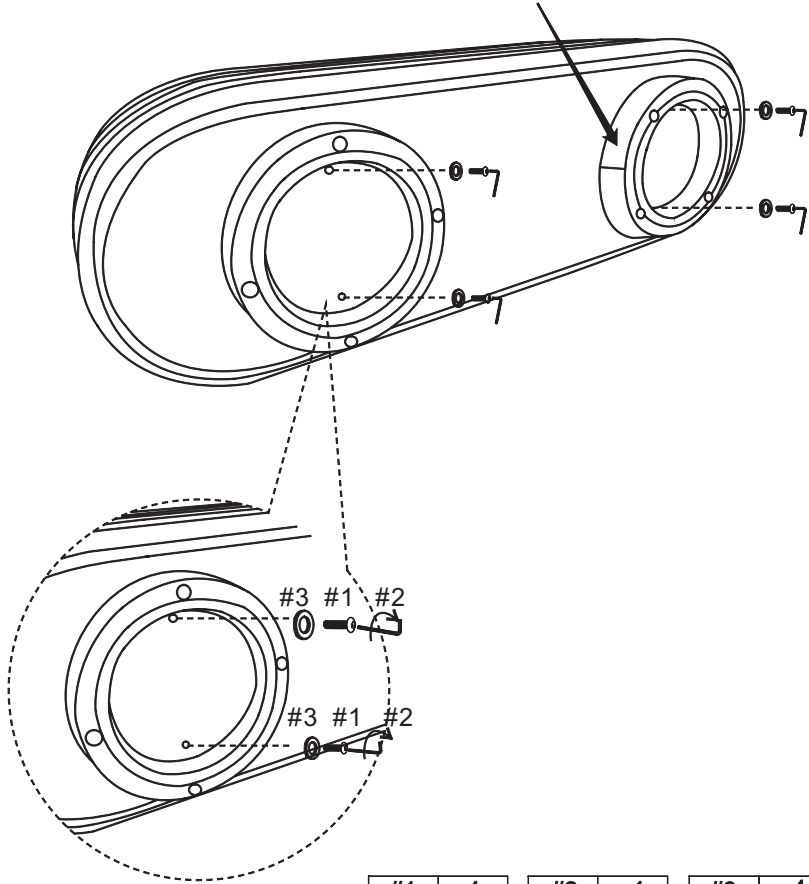
Note that the mental joint is facing inward



#1	x4
	
Ø 6x30mm	

#2	x1
	
M6	

#3	x4
	

Step 3

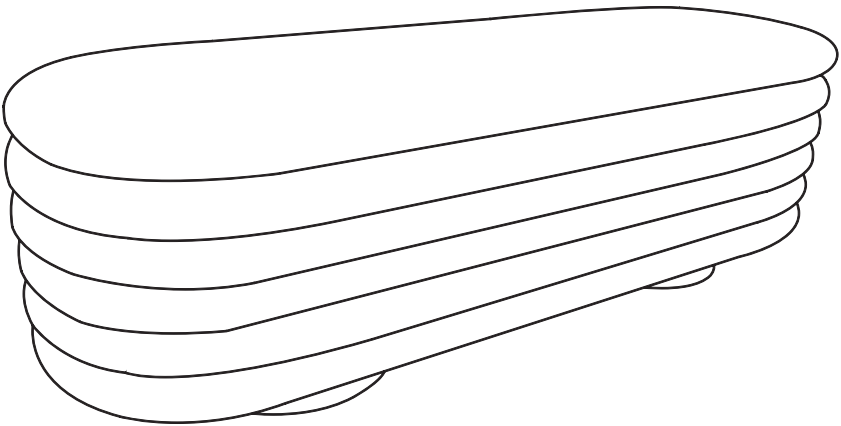

Assembly completed.

Step 4

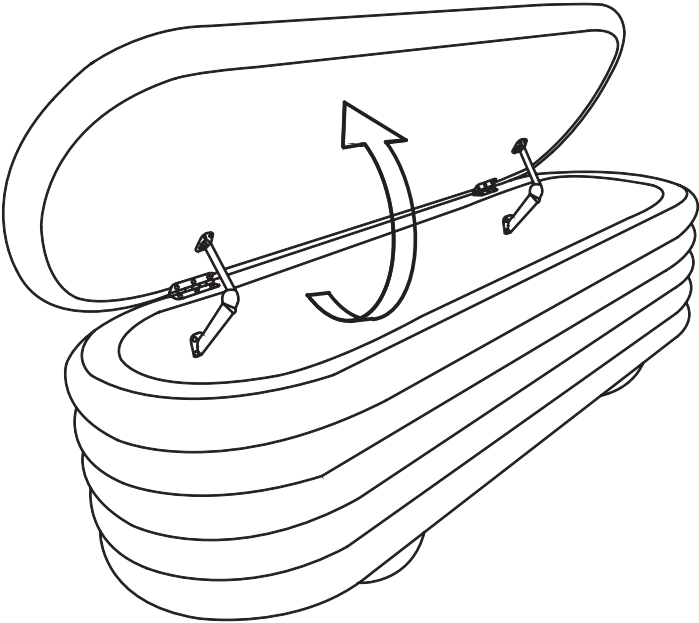

WARRANTY

- We strive to offer quality products, and we also try our best to satisfy every customer who orders from us with products or services as needed.
- We provide 30 days warranty starting from the time you receive the item. Each customer must provide a record of their orders such as the order number, or item receipt for any items that are out of the warranty period you may also still receive.
- Replacement parts by purchasing them from our company if they are available.
- For return, please check the return policy with the retailer or market place you bought from.

**Appreciate your purchasing from us.
Pop up your life by our furniture piece!**