

# Dehumidifier

## Instruction Manual

AS-CSJ72XK-2WT-0L

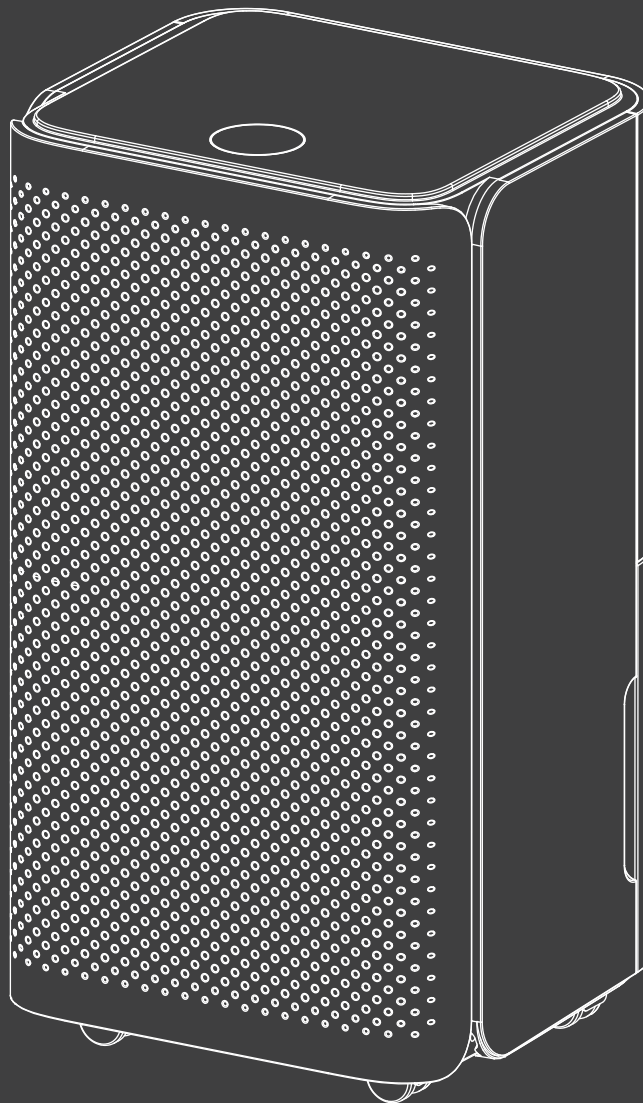
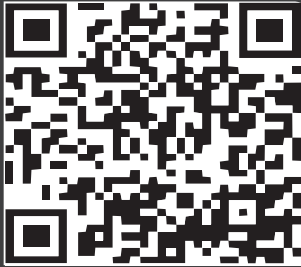

✉ [HJ-Customer-Service@outlook.com](mailto:HJ-Customer-Service@outlook.com)

☎ (909)637-7665 | (909)637-7593

EST 9:00AM--17:00PM

# TABLE OF CONTENTS

1. BEFORE YOU BEGIN .....	1
2. FOR YOUR SAFETY .....	2-4
3. FEATURES .....	4
4. PRODUCT DIAGRAM.....	5
5. OPERATIONS .....	5-8
6. MAINTENANCE .....	9
7. TROUBLESHOOTING .....	9-10
8. STORAGE .....	11
9. DISPOSAL .....	11

**Please retain this manual for further reference! Thank you for choosing our dehumidifier. Please read this manual carefully before using the dehumidifier. If you encounter any issues, please contact our after-sales service for assistance.**

## **1. BEFORE YOU BEGIN**



### **1.1 Product Overview**

The dehumidifier is designed to remove excess moisture from the air. This reduction in relative humidity helps protect buildings and their contents from the harmful effects of high humidity.

This unit contains the environmentally friendly refrigerant R290, which has no ozone depletion potential (ODP) and a negligible global warming potential (GWP). Its high energy efficiency makes it well-suited for this application. **Due to its flammability, special precautions must be observed.**

**Let the unit stand upright for 12 hours before first use.**

### **1.2 Symbols on the Unit and in the User Manual**

	This unit contains a flammable refrigerant. If the refrigerant leaks and comes into contact with an open flame or hot surface, it may produce harmful gases and pose a fire hazard.
	Read this User Manual carefully before operating the unit.
	Service personnel must read this User Manual thoroughly before performing any work on the unit.



**WARNING: Please read this manual carefully and fully understand before operating this dehumidifier.**

## **2. FOR YOUR SAFETY**

### **2.1 Always observe the following safety instructions**

#### **WARNING**

- This unit can be used by children aged 8 years and above and by persons with reduced physical, sensory, or mental capabilities, or lack of experience and knowledge, only if they have been given supervision or instruction on safe use of the unit and understand the hazards involved.
- Children must not play with the unit.
- Cleaning and user maintenance must not be carried out by children.
- This unit is designed to operate only with **R-290 (propane)** as the designated refrigerant.
- The refrigerant circuit is sealed. Servicing must be performed only by qualified technicians.
- Do not discharge the refrigerant into the atmosphere.
- R-290 (propane) is flammable and heavier than air. It can accumulate in low-lying areas (such as near the floor or in basements) and may be circulated by air movement.
- If refrigerant leakage is suspected, do not allow untrained personnel to investigate.
- R290 is odorless. The absence of smell does not guarantee the absence of leaked gas.
- If a leak is detected, immediately evacuate all persons from the area, ventilate the room, and notify the local fire department that an R290 leak has occurred.
- Do not re-enter the area until a qualified service technician has confirmed it is safe.
- Do not use open flames, cigarettes, or any other sources of ignition near the unit.

#### **CAUTION**

- This unit is intended for household and similar applications, including use in offices, shops, light commercial environments, and farms.
- All component parts are designed for use with R290 refrigerant and are non-sparking. Replace components only with identical parts approved by the manufacturer.



**FAILURE TO FOLLOW THE ABOVE WARNINGS AND CAUTIONS COULD RESULT IN EXPLOSION, SERIOUS INJURY, DEATH, OR PROPERTY DAMAGE.**

## 2.2 OPERATIONAL PRECAUTIONS

### **WARNING: To reduce the risk of fire, electric shock, injury to persons, or damage to property:**

- If the power supply cord is damaged, immediately stop using the unit and have it replaced by the manufacturer or a similarly qualified person to avoid a hazard.
- Disconnect the unit from the power source before servicing.
- Always operate the unit only with a power source of the same voltage, frequency, and rating as indicated on the product identification plate.
- Always use a properly grounded power outlet.
- Do not use an extension cord or an adapter plug, as this may cause overheating or fire hazard.
- Unplug the unit when cleaning or when not in use, and do not unplug by pulling on the power cord.
- Do not operate the unit with wet hands.
- Prevent water from spilling onto the unit.
- Do not immerse or expose the unit to rain, moisture, or any other liquids.
- Do not leave the unit running unattended.
- Do not tilt or turn over the unit.
- Do not operate the unit if it is dropped, damaged, or showing signs of malfunction.
- Do not climb on or sit on the unit.
- Do not insert fingers or any objects into the air outlet.
- Do not touch the air inlet or the aluminum fins of the unit.
- Do not clean the unit with any chemicals.
- Do not use any method to accelerate the defrosting process or to clean the unit other than those recommended by the manufacturer.
- Keep the unit away from fire, flammable, or explosive materials.
- Install the unit in accordance with national wiring regulations.
- Store the unit in a room free from continuous sources of heat or open flames, such as operating gas appliances or operating electric heaters.
- Store the unit in a way that prevents mechanical damage.
- Do not pierce or burn the unit, even if it is discarded or no longer in use.
- Store the unit in a well-ventilated area, where the room size meets the minimum requirements specified for operation.
- Refrigerant may be odorless; absence of smell does not indicate absence of leakage.

- Protect all pipe-work from physical damage and do not install it in an unventilated space smaller than 4 m<sup>2</sup>.
- Comply with national gas regulations where applicable.
- Keep all required ventilation openings clear of obstruction.

 <b>WARNING</b>	<p>Any person working on or servicing a refrigerant circuit must hold a valid, current certificate from an industry-accredited assessment authority, authorizing their competence to handle refrigerants safely in accordance with an industry-recognized assessment specification.</p>
 <b>WARNING</b>	<p>Servicing must be performed only as recommended by the equipment manufacturer. Maintenance and repairs that require assistance from other skilled personnel must be carried out under the supervision of a person competent in handling flammable refrigerants.</p>

If you have any questions regarding the operation or safety of this dehumidifier, please contact our after-sales service for assistance.

### 3. FEATURES

- Powerful moisture removal.
- Humidity display shows current humidity.
- Auto mode adjusts humidity levels.
- 24-hour timer for operation.
- Removes moisture and dust from the air.
- Low power consumption, energy-efficient.
- Quiet fan with two speed settings.
- Automatic defrost at low temperatures.
- Automatic shut-off and restart.
- Electronic controls.
- Laundry drying function.
- Nylon filter.
- Two drainage options: continuous drainage via drain hose or 2 L water tank.
- Air purification with ionizer.

## 4. PRODUCT DIAGRAM

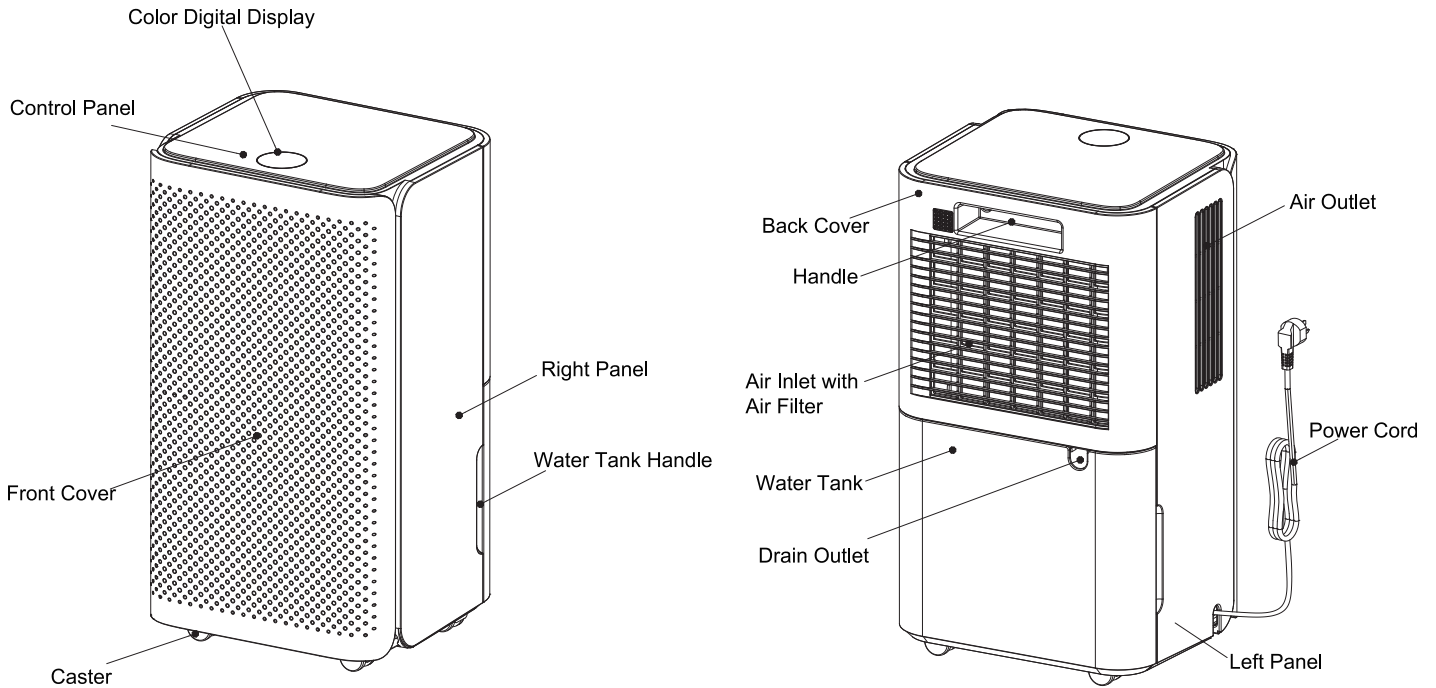

## 5. OPERATIONS

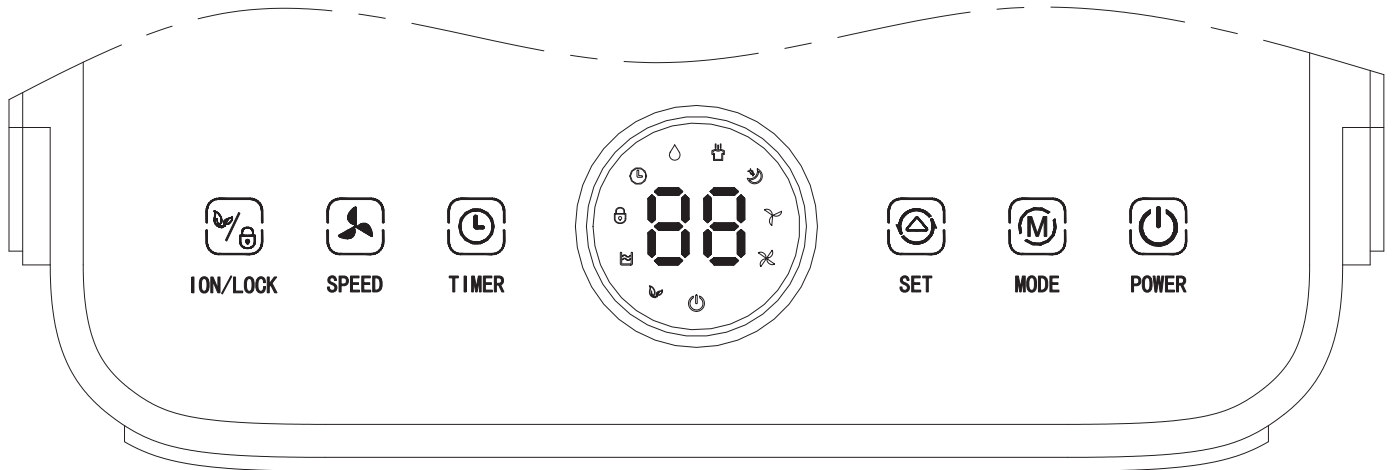

### POWER

When the unit is connected to power, a beep will sound and the display will light up, showing the current ambient humidity level. The unit will then enter standby mode with the display remaining on. Press this button to start operation. The unit will run in Auto mode with a default target humidity of 50% RH and high fan speed.



## SET

Use this button to adjust the target humidity level from 30% to 80%, increasing by 5% with each press.









After pressing the TIMER button , use this button to set the timer from 00 to 24 hours, increasing by 1 hour with each press.

Long press this button to display the current ambient temperature. After about 5 seconds, the screen will automatically return to displaying the current humidity.



## MODE

Press this button to toggle between Auto mode and Continuous Drying mode. Press and hold for about 5 seconds to enter Sleep mode. The corresponding mode icon appears on the display to indicate the selected mode.

- **Auto mode:** In this mode, the  icon lights up. When the ambient relative humidity (RH) is  $\geq$  the set target RH + 3%, the fan starts immediately and the compressor starts after a 3-second delay. When the ambient RH is  $\leq$  the set target RH - 3%, the compressor stops and the fan stops after a 30-second delay. You can press the SET button  to adjust the target humidity level from 30% to 80%, and press the SPEED button  to adjust the fan speed (Low/High).
- **Continuously Drying mode:** In this mode, the  icon lights up. The compressor keeps working regardless of the humidity level. You can adjust the fan speed with the SPEED button , but the target humidity level cannot be adjusted with the SET button .
- **Sleep mode:** Long press the MODE button  to enter Sleep mode. In this mode, the target humidity remains the same as in the previously selected mode. About 10 seconds after activation, the display will turn off all icons and digits except for the Power icon  and the Sleep icon . Pressing any button will wake up the display. At the same time, the fan speed will automatically switch to Low. In this mode, you can also use the SET button to adjust the target humidity level, but the SPEED button cannot be used to change the fan speed.



## TIMER

After pressing the TIMER button, press the set button to set the timer from 00 to 24 hours, increasing by 1 hour with each press.

In operating mode, the timer can be used to schedule automatic shutdown.

In standby mode, the timer can be used to schedule automatic startup.

Setting the timer to "00" cancels the function.



## SPEED

In Auto and Continuous Drying modes, press this button to toggle between Low and High fan speeds. The corresponding fan icon will light up. In Sleep mode, the fan speed is fixed to Low, and this button is disabled.



## Child Lock /Air Purification

Press and hold this button to turn the child lock on or off and the corresponding icon (🔒) will appear on the display.

In operating mode, press this button to activate the Air Purification (Ionizer Function).

In standby mode, press and hold the SPEED button (🌀) to enable the Air Purification (Ionizer Function) independently (the compressor will not operate). The corresponding icon will appear on the display.

## Ambient Humidity Display Ring:

a) The ring on the display changes color according to the ambient humidity:

Humidity < 44% → Blue

44% ≤ Humidity ≤ 46% → Maintain previous color (Blue or Green)

46% < Humidity < 64% → Green

64% ≤ Humidity ≤ 66% → Maintain previous color (Green or Red)

Humidity > 66% → Red

b) The ring turns red when a fault occurs.

c) When the unit is off, the ring is not illuminated.

d) The ring is always on by default during operation (except in Sleep mode) and does retain the previous color from the last setting.

## EMPTYING THE WATER TANK:

When the water tank is full, the unit will sound an alarm and the water-full icon (🌊) will appear on the display.

1. Press the POWER button to turn off the unit.
2. Remove the water tank.
3. Empty the water into a drain or a suitable outdoor area.
4. Clean both the inside and outside of the water tank.
5. Replace the empty tank back into the unit.
6. Press the POWER button to resume operation.
7. If the water-full icon (🌊) remains on, check that the float is properly seated.

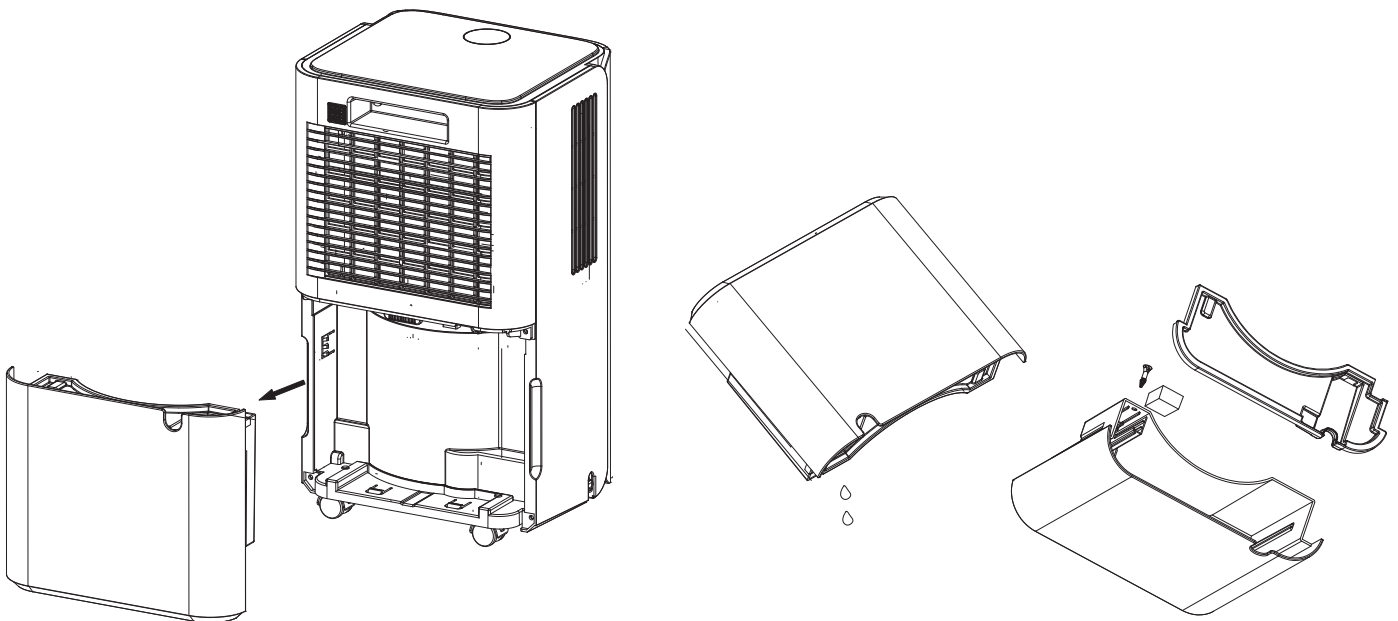

## WARNING:

Do not discard the water tank magnets, plastic rivets, and float. If removed, the unit will not automatically stop when the water tank is full, and the condensate may overflow, potentially damaging the floor.

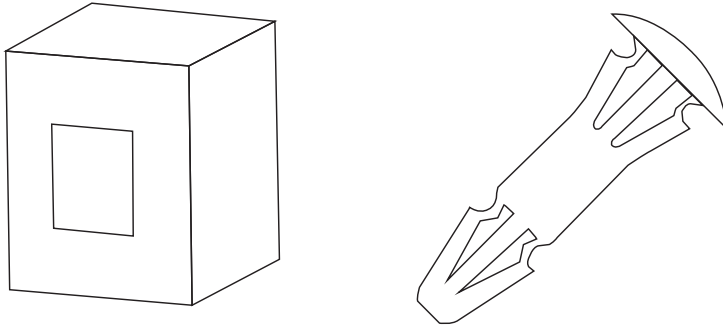

Always empty the water tank before changing the operating mode of the unit. If the water tank is dirty, rinse it with clean water. Do not use detergents, steel balls, chemical cleaners, diesel, benzene, thinners, or other solvents, as they may damage the tank or cause leaks. Replace the empty tank back into the unit. Otherwise, the water-full icon on the display may remain on, and the unit may not restart.

## CONTINUOUS DRAINING

For continuous operation or unattended dehumidification, connect the attached drain hose to the unit. The condensate can automatically flow into a bucket or drain by gravity.

Straighten the drain hose.

Insert one end of the hose into the drain outlet of the unit, and place the other end into a bathroom drain, outdoor drain, bucket-like container, or other approved drainage area.

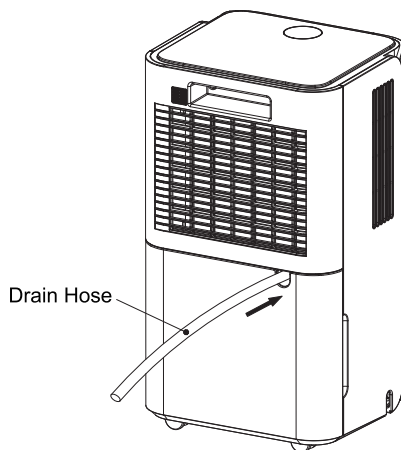

## WARNING:

Do not block the drain or drain hose. If blockage occurs, condensate may flow back into the water tank. Do not bend the drain hose. The end of the drain hose must be lower than the unit's drain outlet. Ensure the drain hose is securely connected to the drain outlet of the unit.

## 6. MAINTENANCE

**Note:** Before cleaning or performing maintenance on the unit, turn off the unit and unplug it to prevent electric shock.

### 6.1 Cleaning the Air Filter (every two weeks)

- Dust accumulates on the air filter, restricting airflow and reducing the system's efficiency. If the filter becomes blocked, it may damage the unit.
- The air filter requires regular cleaning and is designed to be easily removed. Never operate the unit without the air filter installed, as this may contaminate the evaporator.

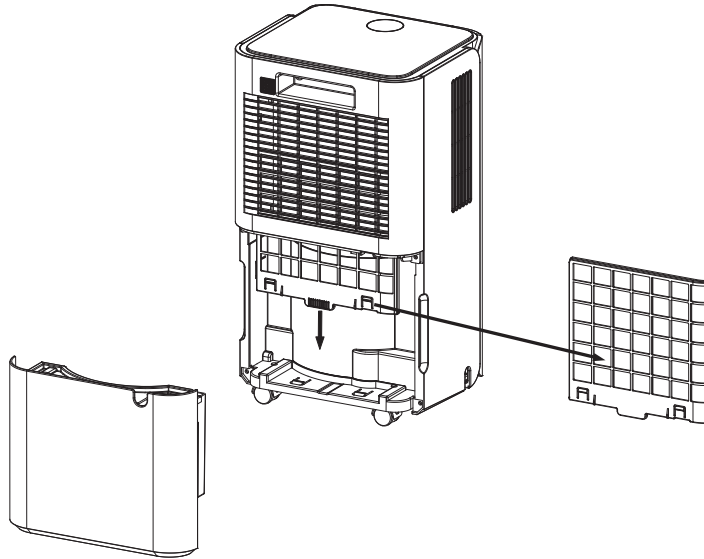

1. Remove the water tank from the body, then pull out the filter from inside the back cover.

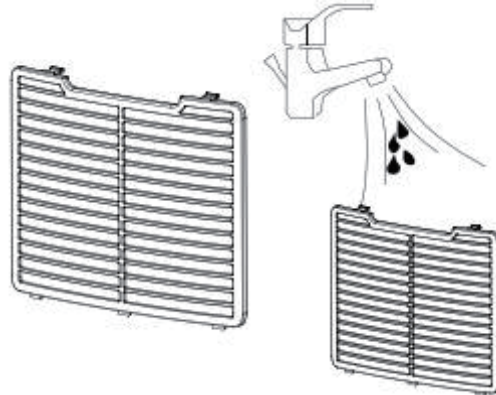

2. Use a vacuum cleaner to gently remove dust from the surface. If the filter is heavily soiled, wash it with water and a mild detergent, and make sure it is completely dry before reinstalling.

3. Reinstall the filter.



## 7. TROUBLESHOOTING

### 7.1 Operating Temperature

$5^{\circ}\text{C} \leq \text{Ambient Temp.} \leq 38^{\circ}\text{C}$

The dehumidifier will stop operating if the ambient temperature is outside this range.

## 7.2 Automatic Defrost Function

When frost is detected on the evaporator after a period of operation, the unit automatically enters defrost mode. During defrosting, the corresponding icon (  or  , depending on the selected mode) will flash on the display.

## 7.3 Before Requesting Service

Before contacting customer service, review the troubleshooting list for common situations that are not caused by defects in materials or workmanship.

<b>Problem</b>	<b>Possible Cause</b>	<b>Solution</b>
Unit not working	No power supply	Plug the unit into a working outlet and switch it on.
	The water tank is full	Empty the water tank and reinstall it correctly. Ensure the float is properly seated. If using the drain hose, check for blockage and keep the tank installed.
	Ambient temperature outside the operating range (5-38 °C)	Ensure the unit is used in an environment where the ambient temperature is within the specified operating range. The unit will resume operation automatically once the temperature returns to normal.
Poor performance	Air filter clogged	Clean/wash the air filter as instructed.
	Air inlet or outlet obstructed	Remove obstructions. Keep required clearances around the unit.
No/weak airflow	Air filter clogged	Clean/wash the air filter as instructed.
Loud noise during operation	Unit not placed on a flat, level surface	Place the unit on a flat, stable surface.
	Air filter clogged	Clean/wash the air filter as instructed.
Code: FL	Water tank full	Empty the water tank and reinstall it; ensure the float is properly seated.
Code: EF	DC motor fault	Turn off and unplug the unit. Contact after-sales service.
Code: E1/E2	Sensor fault	Change a sensor
Display: 20%RH	Ambient humidity is below 20% RH (out of measurement range)	The unit shuts down for self-protection
Display: 90%RH	Ambient humidity is above 90% RH (out of measurement range)	
Code: CL	Low-temperature protection (< 5 °C)	
Code: CH	High-temperature protection (≥ 39 °C)	

## 8. STORAGE

Long-term storage: If you will not be using the unit for an extended period of time (more than a few weeks), it is best to clean the unit and dry it out completely. Please store the unit following these steps:

1. Press the power button to switch off and unplug the unit.
2. Drain the remaining water from the unit.
3. Clean the filter and let it dry completely in a shaded area.
4. Secure the power cord to the holder near the water tank.
5. Reinstall the filter in its original position.
6. Keep the unit in an upright position during storage.
7. Store the unit indoors in a well-ventilated, dry, non-corrosive, and safe place.

### **ATTENTION:**

To prevent component damage and mold, the internal evaporator must be completely dried before packing the unit.

1. Unplug the unit and place it in a dry, well-ventilated area for several days.
2. Alternatively, set the humidity point at least 5% higher than the ambient humidity and run the unit for a couple of hours to dry the evaporator.

## 9. DISPOSAL

### **WARNING:**

Releasing refrigerant into the atmosphere is strictly prohibited!



Do not dispose of electrical appliances as unsorted municipal waste. Use designated collection facilities instead. Contact your local authorities for information on available collection systems. Improper disposal in landfills or dumps may cause hazardous substances to leak into groundwater and the food chain, potentially harming health.

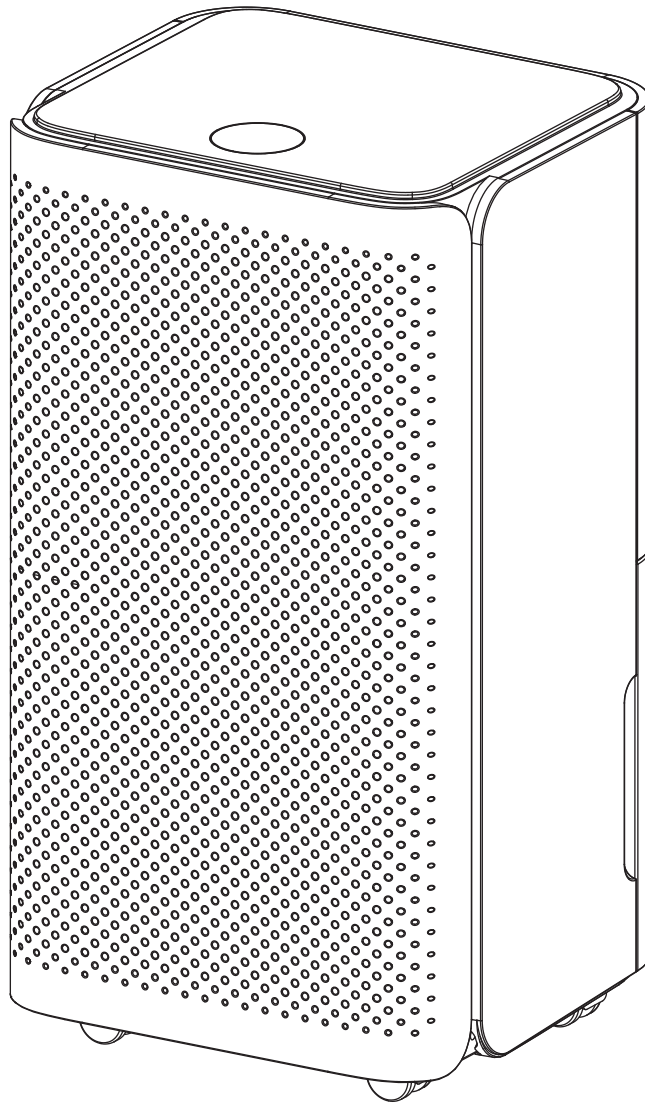

## **Technical Support**

(909)637-7665 | (909)637-7593

## **Other Info**

HJ-Customer-Service@outlook.com

Thank you for choosing this product. We strive to provide you with the best quality products and services in the industry. Should you have any issues, please don't hesitate to contact us.



